















**E. C. ATKINS & Co., Inc.**

ESTABLISHED 1857

INCORPORATED 1885

INDIANAPOLIS, INDIANA, U. S. A.

*Best Abrazing*



# SAWS

SAW TOOLS  
MILL  
SPECIALTIES

1911

HARDWARE EDITION, No. 11

*BRANCH HOUSES:*

ATLANTA, GA.

MINNEAPOLIS, MINN.

SEATTLE, WASH.

CHICAGO, ILL.

NEW ORLEANS, LA.

SAN FRANCISCO, CAL.

MEMPHIS, TENN.

NEW YORK CITY.

PORTLAND, ORE.

CANADIAN FACTORY, HAMILTON, ONTARIO.

Entered according to Act of Congress, in the year 1911, by  
E. C. ATKINS & Co., INC., SHEFFIELD SAW WORKS, INDIANAPOLIS, IND.  
At the office of the Librarian of Congress, Washington, D. C.



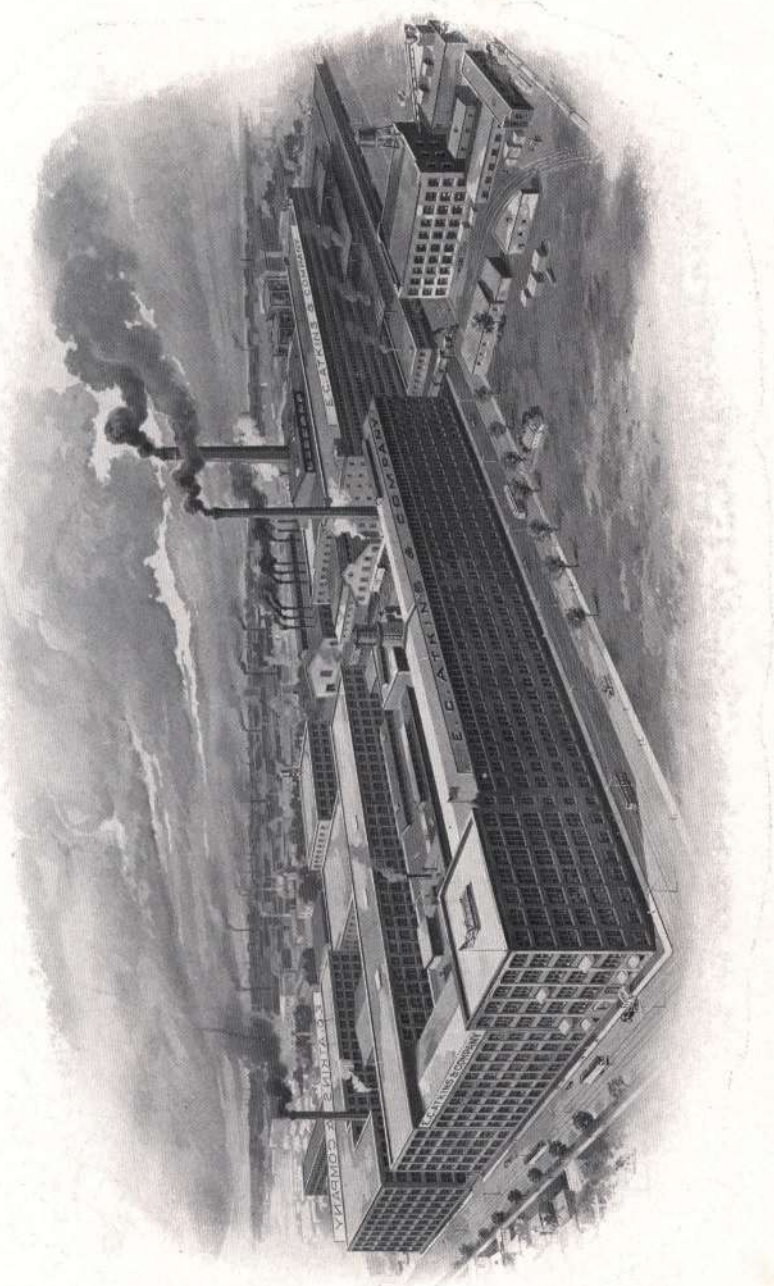

THE HOME OF THE ATHINS SAW, INDIANAPOLIS, IND., U. S. A.

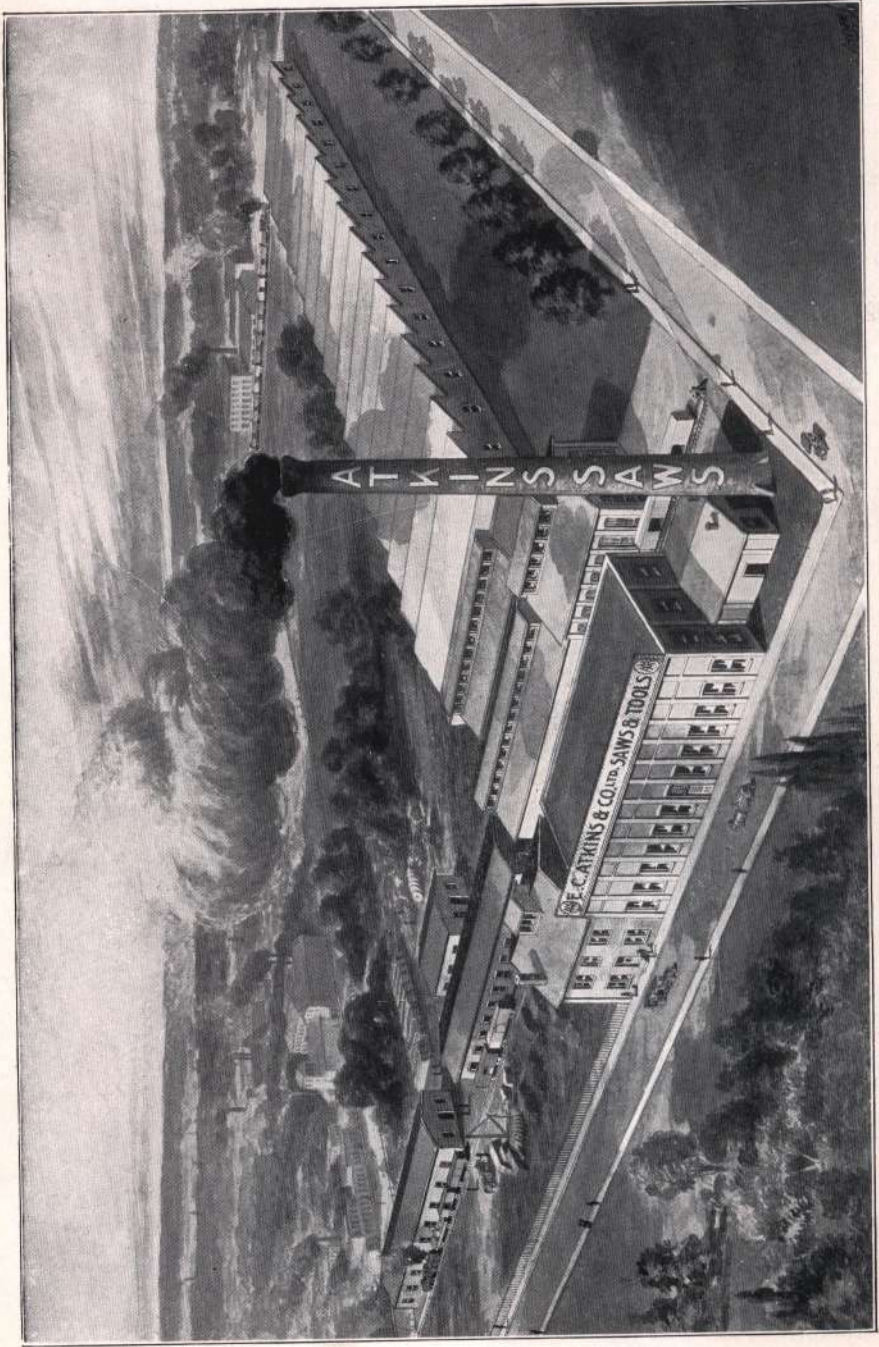

Hamilton, Ontario

E. C. ATKINS & CO., Ltd.

Our Canadian Factory



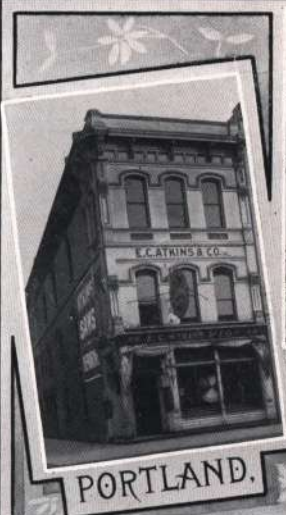

PORTLAND.



MINNEAPOLIS.



CHICAGO.



NEW ORLEANS.



NEW YORK.



SAN FRANCISCO.



MEMPHIS.



ATLANTA.



SEATTLE.

OUR BRANCHES

1892-5 140- CO

## This Will Interest You Read It

Everything listed in this book is made with a fixed purpose in view. They have been made with the idea of supplying RELIABLE PEOPLE WITH RELIABLE GOODS—the very best the market affords.

Atkins Silver Steel is the finest crucible steel that has ever been put into saws. It could not be better if it cost twice as much. It is made for us under our own secret formulas as best suited to the different types of saws in which it is to be used. Subjected to our secret process of gas tempering, it acquires that perfect degree of hardness and stiffness without being brittle that enables it to stand up to its work the longest.

Every process of manufacture is in the hands of experts who guide the work through to a successful completion, so that the finished product is as perfect as money and brains can produce. You may rest assured that every saw bearing the name of Atkins is one that you can use yourself or recommend to your customer with confidence. The saving of a few dollars in the cost of manufacture has no attractions for us, because we have established our business on the QUALITY basis and do not cater to the buyer of unreliable merchandise.

As manufacturers, we offer the manufacturers brand, which MUST be reliable. Careful inspection is made after each particular operation, thus insuring a uniformity of output. So that the product of our factory bearing the name of "Atkins" may always be relied upon as uniform and fully up to our high standard of quality in every respect.

You will also notice the most complete line of Saw Tools and Specialties for the proper care of saws that has ever been shown within the covers of any book. These are the most improved inventions of the age in the Saw Tool line, and show the most marked advancement in this department of manufacture.

### TOOL MANUFACTURING DEPT.—SPECIAL SAWS.

We have unsurpassed facilities for the manufacture of any specialty or tool in which sheet steel is to be used, and would be pleased to submit most favorable prices.

### OUR MACHINE KNIFE DEPARTMENT.

As in all other lines shown herein, we excel on Machine Knives of all descriptions. This is an entirely separate department where a specialty is made of only the best knives of every class. No style of knife is too complicated for us, and the features of material, welding and accurate grinding are given the most minute consideration.

### OUR BRANCHES.

We carry a complete line of Standard Saws of every description at all our Branches named at top of pages, as well as Knives and Mill Supplies, thus insuring the benefit of prompt delivery and lowest freight rates. Orders sent to any Branch will receive prompt attention.

### REPAIR WORK.

Complete Repair Shops are maintained at Atlanta, Memphis, Minneapolis, New Orleans, Portland, San Francisco, Seattle and Indianapolis for prompt and accurate execution of work of this character.

Holding ourselves in readiness to serve you, we remain,

**E. C. ATKINS & CO., Inc.**  
The Silver-Steel Saw People



## TERMS OF WARRANTY.

Each saw is warranted as true as it is possible to make it, and free from flaws and seams. If found to be defective in any of these particulars it may be returned, and if, upon examination, the saw is found to be at fault, all necessary repairs will be made free of charge or a new saw given in exchange, provided it is returned within thirty days from delivery.

Saws cracked or broken, as the result of filing square corners in the gullets, or from using a cold-chisel or punch in re-toothing, will not be replaced under our warranty.

Any alterations in the holes of a circular saw by filing, reaming, or otherwise, will generally spring the saw. When such alteration is made, the saw will not be subject to above warranty.

The name of "E. C. Atkins & Co." on a saw is assurance to the buyer of its superior quality and reliability.

**E. C. ATKINS & Co., INC.**

## OUR CANADIAN FACTORY.

We are pleased to show, on one of the previous pages, a birdseye picture of our new CANADIAN FACTORY. This is located at Hamilton, a point which is admirably situated to take care of our rapidly growing Canadian business.

We shall manufacture at this point, a full line of Saws, including Bands, Circulars, Drag, Gang and Mill Saws of all kinds, as well as Cross-Cut Saws, Hand, Wood and Small Saws.

We are in a position to take care of any Canadian business entrusted to us, promptly and satisfactorily.

## Special Notice

Unless parties are known to us or furnish us with satisfactory commercial reference, cash should always accompany orders, otherwise we will follow our custom in such cases and send the goods C. O. D.

Orders for all special work, saws or supplies, not catalogued, should be accompanied with a remittance.

Packages not exceeding four pounds in weight will be sent by mail when so ordered, the purchaser to pay postage and assume the risk of loss. If registered, the additional cost will be 8 cents.

All orders submitted through our agents or by mail are subject to our approval. If declined, the parties will be notified at once.

All goods are shipped at purchaser's risk.

All prices are f. o. b. factory.

Quotations are subject to change without notice and goods invoiced at current prices when shipped.

Errors in bills or shortages should be reported immediately upon receipt of goods.

Be particular to give correct and explicit shipping directions with order, and thereby avoid unnecessary delays in delivery.

All bills are payable in New York exchange or other funds current at par at Indianapolis.

We reserve the right to correct stenographic errors on quotations or other important matters, and will not be held responsible for delays caused by strikes, acts of Providence, or other unavoidable causes.

Very truly,

**E. C. ATKINS & Co., INC.**



**Medals Awarded  
E. C. Atkins & Co.**

**CENTENNIAL EXPOSITION,**

**PHILADELPHIA, 1876.**

**FIRST MEDAL.**



**WORLD'S COLUMBIAN EXPOSITION,**

**CHICAGO, ILLINOIS, 1893.**

**HIGHEST AWARDS ON**

**CIRCULAR, CYLINDER, BAND, GANG, DRAG,  
CROSS-CUT AND HAND SAWS,**

**For Variety Exhibited, Material, Workman-  
ship and Finish.**



**EXPOSITION UNIVERSELLE  
INTERNATIONAL,**

**PARIS, 1900.**

**TWO GOLD MEDALS.**

**One for BEST CIRCULAR AND BAND SAWS.**

**One for BEST CROSS-CUT AND HAND SAWS.**



**PAN-AMERICAN EXPOSITION,**

**BUFFALO, N. Y., 1901.**

**TWO GOLD MEDALS.**

**HIGHEST AWARDS ON**

**CIRCULAR, BANDS, GANG, DRAG, CYLINDER  
AND MILL SAWS.**

**CROSS-CUT, HAND AND SMALL SAWS.  
SAW TOOLS.**



We have many others, including the Cotton States Expositions at New Orleans and Atlanta.

— ATKINS SILVER STEEL SAWS —

E. C. ATKINS & CO.'S  
REGISTERED TRADE MARKS.

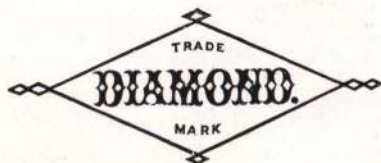

**D E X T E R**

(TRADE MARK)

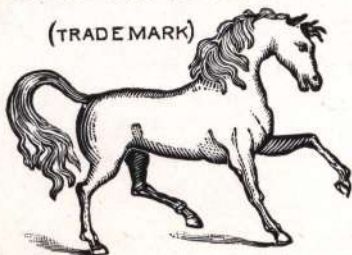

**P H O E N I X**





## THE ATKINS TELEGRAPHIC CODE.

We call particular attention to our new FIVE-LETTER CODE, as given below, and respectfully ask our patrons to make use of same, as far as possible, when telegraphing.

### Time and Manner of Shipping.

Aback .... Express at once.  
 Abaft .... Freight at once.  
 Abash .... Express as soon as possible.  
 Abate .... Freight as soon as possible.  
 Abbey .... Answer, saying when you can ship.  
 Abeam .... Order confirmed by mail.  
 Abhor .... When will you ship order?  
 Abide .... If you cannot ship at once, advise us by wire.  
 Abode .... Customer in great hurry.  
 Abyss .... Customer will cancel if not shipped at once.

### Shipments Questions.

Abuse .... Shall we ship via rail?  
 Acorn .... Shall we ship via rail and lakes?  
 Acrid .... Shall we ship via steamer?  
 Actor .... Shall we ship via express?  
 Acute .... Shall we ship via sailing vessel?  
 Adage .... Shall we ship via cheapest route?  
 Adapt .... Shall we ship via quickest route (freight)?  
 Adder .... When will you ship?  
 Admix .... When can you ship?  
 Adult .... Can you ship us promptly?  
 Agape .... Can you ship today?  
 Agate .... Can you make shipment by the  
 Agast .... Can you ship on receipt of order?  
 Agile .... Can you furnish within  
 Agone .... When can you ship us partial shipment?  
 Aneal .... When can you make complete shipment of our order?  
 Abear .... When will you complete our order?  
 Angel .... When and how did you make shipment?  
 Anger .... Where did you make shipments?  
 Angle .... Shall we get through rate of freight?  
 Anise .... Shall we prepay freight?  
 Anise .... Shall we prepay express?  
 Ankle .... Shall we send wire tracer after shipment?  
 Annal .... Shall we cancel unfilled portion of order?  
 Annex .... Shall we hold for shipping instructions?  
 Annoy .... Shall we make partial shipment, balance later?  
 Antic .... Shall we enter order to be shipped at earliest date possible?

### Shipments Answers.

Apace .... Ship via rail.  
 Apeak .... Ship via rail and lakes.  
 Apery .... Ship via steamer.  
 Apian .... Ship via express.  
 Apish .... Ship via sailing vessel.  
 Aport .... Ship via cheapest route.  
 Appal .... Ship via quickest route (freight).  
 Apron .... We can ship  
 Aptly .... We can ship at once.  
 Araby .... We expect to ship today.  
 Ardor .... We expect to ship  
 Arear .... We expect to ship order complete  
 Areek .... We expect to make partial shipment  
 Arena .... We expect to ship balance of order  
 Argon .... We made you shipment  
 Argot .... We completed your order  
 Argue .... Shipment was made to  
 Argus .... Shipment was made by  
 Arian .... Shipment was made on  
 Ariel .... We will ship as soon as possible.  
 Arise .... We can make shipment on receipt of order.  
 Armed .... We cannot promise definitely.  
 Armor .... Impossible for us to fill your order in time specified.  
 Arose .... If ordered immediately, can ship  
 Array .... If ordered today, can ship  
 Arrow .... Will do our best to ship earlier.  
 Aside .... Will try to ship in 1 day.  
 Aspen .... Will try to ship in 2 days.  
 Aspic .... Will try to ship in 3 days.  
 Assay .... Will try to ship in 4 days.  
 Astel .... Will try to ship in 5 days.  
 Astun .... Will try to ship in 6 days.  
 Asure .... Will try to ship in 7 days.  
 Atilt .... Will try to ship in 8 days.

### Shipments Answers—Cont'd.

Atimy .... Will try to ship in 9 days.  
 Atjar .... Will try to ship in 10 days.  
 Atluk .... Will try to ship in 2 weeks.  
 Atman .... Will try to ship in 3 weeks.  
 Atoll .... Will try to ship in 4 weeks.  
 Atone .... Will try to ship in 5 weeks.  
 Attic .... Will try to ship in 6 weeks.  
 Attus .... Will try to ship in 60 days.  
 Brand .... Will try to ship tomorrow.  
 Bride .... Will try to ship in week to 10 days.  
 Beeze .... Will try to ship in 10 days to 2 weeks.  
 Booze .... Will try to ship in 2 to 3 weeks.  
 Brade .... Will try to ship in 3 to 4 weeks.  
 Broad .... Will try to ship in 4 to 5 weeks.  
 Batem .... Will try to ship in 5 to 6 weeks.  
 Brace .... Will try to ship in 6 to 8 weeks.

### Shipments Instructions.

Audit .... Please send shipping instructions.  
 Auget .... We have sent wire tracer after shipment.  
 Aunty .... Ship today sure.  
 Aural .... Ship today or cancel.  
 Auris .... Ship as soon as possible.  
 Avail .... Ship on the date specified without fail.  
 Avens .... Ship at once any portion of our order.  
 Avert .... Ship today what you have ready and balance at earliest convenience.  
 Avian .... Very urgent, rush order.  
 Aview .... Cancel our order.  
 Avoke .... Cancel balance of order.  
 Awake .... Cancel balance of order unless shipped by  
 Awful .... We are entirely out of  
 Awned .... We are urgently in need of  
 Axiom .... Send wire tracer after shipment.  
 Axmon .... Get through rate of freight.  
 Aziam .... Prepay freight.  
 Azale .... Prepay express.

### Prices.

Bacon .... At what prices can you furnish?  
 Badge .... At what price and how soon can you furnish?  
 Bafta .... Prices are subject to change without notice.  
 Baggy .... We quote you  
 Bairn .... We can not furnish  
 Baize .... Not less than  
 Baked .... Delivery in your city.  
 Baken .... Free on board at  
 Baler .... Less freight allowance per 100 pounds of  
 Balky .... Please send specifications in detail.  
 Balmy .... We cannot accept offer  
 Balsa .... You can quote  
 Basop .... We have not quoted.  
 Bater .... If necessary to meet competition, you can quote.

### Orders.

Banal .... We have entered your order for  
 Bandy .... Enter our order at prices named.  
 Banjo .... Will you accept order?  
 Banns .... We accept your order.  
 Banty .... Duplicate our order  
 Barky .... Enter our order for  
 Baron .... Send detail specifications.  
 Basal .... We cannot accept your order.  
 Basic .... Order confirmed by mail.

### Cancellations.

Badar .... We will cancel your order.  
 Babam .... We cancelled your order.  
 Babdo .... We cannot cancel your order.

### General.

Basso .... See letter of this date.  
 Baste .... Please reply immediately by telegraph.  
 Basy1 .... Your telegram is unintelligible, please repeat  
 Batam .... See at once, are in market for.

## Discounts.

Per Cent.	Per Cent.
Batch ..... 2	Bites ..... 45
Bathe ..... 2½	Blame ..... 50
Baton ..... 3	Bland ..... 50-5
Bazar ..... 5	Blare ..... 50-10
Beaky ..... 7½	Blast ..... 50-10-5
Beamy ..... 10	Blaze ..... 50-10-10
Beard ..... 15	Bleak ..... 55
Beast ..... 20	Blear ..... 60
Bedew ..... 20-5	Bless ..... 60-5
Beeve ..... 20-10	Blind ..... 60-10
BeFit ..... 20-10-5	Blink ..... 60-10-5
Befog ..... 20-10-10	Bliss ..... 60-10-10
Belay ..... 25	Bloat ..... 65
Belie ..... 30	Boast ..... 70
Belle ..... 30-5	Bogle ..... 70-5
Berob ..... 30-10	Bogus ..... 70-10
Berry ..... 30-10-5	Boost ..... 70-10-5
Berth ..... 30-10-10	Boots ..... 70-10-10
Beryl ..... 35	Booty ..... 75
Beset ..... 40	Borne ..... 80
Bight ..... 40-5	Bosy ..... 80-5
Bigot ..... 40-10	Bower ..... 80-10
Biped ..... 40-10-5	Boxer ..... 80-10-5
Bison ..... 40-10-10	Braid ..... 80-10-10

## Terms.

Brain ..... 10 days net.
Brash ..... 30 days net.
Bravo ..... 60 days net.
Brawl ..... 90 days net.
Braxy ..... 4 months net.
Breed ..... Special terms per contract.
Bribe ..... 2 per cent. cash in 10 days or 60 days net.
Brier ..... 3 per cent. cash in 30 days.

## Circular and Mill Saws.

Cabal ..... Circular saws, solid tooth rip.
Cabby ..... Circular saws, solid tooth cross-cut.
Cabin ..... Circular saws, solid tooth Kerf King.
Cache ..... Circular saws, solid tooth shingle or heading saws.
Caddy ..... Circular saws, inserted chisel tooth (style tooth No. 5).
Cadet ..... Circular saws, inserted chisel tooth (style tooth No. 4).
Cadge ..... Circular saws, inserted chisel tooth (style tooth No. 3).
Calix ..... Circular saws, inserted chisel tooth (style tooth No. 2½).
Calla ..... Circular saws, inserted chisel tooth (style tooth No. 2).
Camel ..... Circular saws, inserted chisel tooth (style tooth No. 1).
Canal ..... Circular saws, inserted chisel tooth (short holder pattern).
Candy ..... Circular saws, solid tooth, edgers.
Caned ..... Circular saws, solid tooth, re-saws.
Canny ..... Circular saws, solid tooth, top saws.
Canoe ..... Circular saws, veneering saws in segments.
Canto ..... Circular saws, slate.
Caper ..... Circular saws, McKam tooth.
Carib ..... Circular saws, wabble.
Carol ..... Circular saws, lock corner box cutters.
Carom ..... Circular knives.
Carve ..... Circular saws, metal
Caste ..... Circular saws, milling saws for Bryant machine.
Catch ..... Circular saws, milling saws for Higley machine.
Cater ..... Circular saws, lathe.
Catty ..... Circular saws, Tindel high duty.
Cavil ..... Band saws, (mill).
Chafe ..... Band saws, (scroll).
Chalk ..... Mulay saws.
Chant ..... Mulay saws, special pattern for Chandler & Taylor mill.
Charm ..... Gang saws.
Chasm ..... Rift saws.
Chess ..... Drag saws, tapered 8 x 6 inches.
Chide ..... Drag saws, tapered 7 x 5 inches.
Chump ..... Drag saws, tapered 7½ x 4½ inches.
Churn ..... Drag saws, equal width, 10 inches.

## Circular and Mill Saws—Cont'd.

Cider ..... Drag saws, equal width, 8 inches.
Cinch ..... Drag saws, lance tooth.
Clash ..... Drag saws, tuttle tooth.
Cleft ..... Drag saws, mill tooth.
Cleve ..... Drag saws, single hook tooth.
Click ..... Drag saws, Diamond tooth.
Cliff ..... Whip saws.
Climb ..... Pit Saws.
Clink ..... Cylinder Saws.
Cloak ..... Bilge Saws.

## Speed—Revolutions per Minute.

Clerk ..... 200	Comus ..... 1350
Cleve ..... 250	Couch ..... 1400
Click ..... 275	Coney ..... 1450
Cliff ..... 300	Conid ..... 1500
Climb ..... 325	Conne ..... 1550
Cling ..... 350	Cooky ..... 1600
Clipt ..... 375	Coomb ..... 1650
Cloak ..... 400	Cooth ..... 1700
Closh ..... 425	Coppy ..... 1750
Cloud ..... 450	Copsy ..... 1800
Clove ..... 475	Coque ..... 1850
Clown ..... 500	Coral ..... 1900
Clubs ..... 525	Corme ..... 1950
Clump ..... 550	Cosey ..... 2000
Coach ..... 575	Cough ..... 2100
Coact ..... 600	Count ..... 2200
Coaly ..... 625	Coury ..... 2500
Coats ..... 650	Cover ..... 2750
Cocoo ..... 675	Cowan ..... 3000
Codex ..... 700	Cowle ..... 3250
Codle ..... 725	Coxal ..... 3500
Cohog ..... 750	Craze ..... 3750
Coind ..... 775	Craken ..... 4000
Coine ..... 800	Cramp ..... 4500
Coyne ..... 825	Crash ..... 5000
Cokes ..... 850	Crawl ..... 5500
Colic ..... 875	Craze ..... 6000
Colly ..... 900	Cream ..... 6500
Colton ..... 950	Credo ..... 7000
Colza ..... 1000	Creel ..... 7500
Comal ..... 1050	Crisp ..... 8000
Combs ..... 1100	Croak ..... 8500
Comet ..... 1150	Crone ..... 9000
Comic ..... 1200	Crust ..... 9500
Comma ..... 1250	Cyrrer ..... 10000
Compo ..... 1300	

## Diameter.

Daffy ..... 1 inch.	Diary ..... 38 inch.
Dairy ..... 2 inch.	Dicky ..... 40 inch.
Daisy ..... 3 inch.	Digit ..... 42 inch.
Dally ..... 4 inch.	Dingy ..... 44 inch.
Dance ..... 5 inch.	Dirge ..... 46 inch.
Dandy ..... 6 inch.	Dirty ..... 48 inch.
Darby ..... 7 inch.	Doggy ..... 50 inch.
Daunt ..... 8 inch.	Dolce ..... 52 inch.
Davit ..... 9 inch.	Dolly ..... 54 inch.
Dawdy ..... 10 inch.	Dolor ..... 56 inch.
Dazed ..... 11 inch.	Donor ..... 58 inch.
Death ..... 12 inch.	Doric ..... 60 inch.
Debar ..... 13 inch.	Dotty ..... 62 inch.
Debut ..... 14 inch.	Doubt ..... 64 inch.
Decay ..... 15 inch.	Dough ..... 66 inch.
Decoy ..... 16 inch.	Douse ..... 68 inch.
Decry ..... 17 inch.	Dower ..... 70 inch.
Defer ..... 18 inch.	Downy ..... 72 inch.
Deify ..... 19 inch.	Drama ..... 74 inch.
Deign ..... 20 inch.	Drape ..... 76 inch.
Deity ..... 21 inch.	Drawl ..... 78 inch.
Delve ..... 22 inch.	Dread ..... 80 inch.
Demit ..... 23 inch.	Dream ..... 82 inch.
Demon ..... 24 inch.	Drego ..... 84 inch.
Demur ..... 25 inch.	Dress ..... 86 inch.
Denim ..... 26 inch.	Drier ..... 88 inch.
Dense ..... 27 inch.	Drift ..... 90 inch.
Derby ..... 28 inch.	Drink ..... 92 inch.
Deter ..... 29 inch.	Droll ..... 94 inch.
Deuce ..... 30 inch.	Drone ..... 96 inch.
Devil ..... 32 inch.	Droop ..... 98 inch.
Devon ..... 34 inch.	Dross ..... 100 inch.
Diana ..... 36 inch.	



### Gauge.

Eage	30	Enarm	7 x 15
Easel	29	Endaw	7 x 16
Eaves	28	Endie	7 x 17
Eburn	27	Encid	8 x 8
Eburn	26	Enema	8 x 9
Eclat	25	Enemy	8 x 10
Eclat	24	Enerd	8 x 11
Eclat	23	Engin	8 x 12
Ecole	22	Engle	8 x 13
Ectal	21	Ensky	8 x 14
Edder	20	Ensue	8 x 15
Edict	19	Entad	8 x 16
Edify	18	Entry	8 x 17
Edile	17	Envoy	8 x 18
Educ	16	Enzym	9 x 9
Eflag	15	Eosin	9 x 10
Egret	14	Epaet	9 x 11
Eisel	13	Epah	9 x 12
Ejido	12	Ephor	9 x 13
Eking	11	Epoeh	9 x 14
Elaic	10	Epoed	9 x 15
Elamp	9	Epure	9 x 16
Elate	8	Erack	9 x 17
Elder	7	Erato	9 x 18
Elect	6	Erber	10 x 10
Elegy	5	Erbia	10 x 11
Elemi	4	Erect	10 x 12
Efin	3	Ergal	10 x 13
Elide	2	Ergon	10 x 14
Elmes	1	Erica	10 x 15
Elode	5 x 5	Ermin	10 x 16
Eloge	5 x 6	Erose	10 x 17
Eloin	5 x 7	Erump	10 x 18
Elong	6 x 6	Ervm	11 x 11
Elope	6 x 7	Escar	11 x 12
Elsen	6 x 8	Esmal	11 x 13
Elute	6 x 9	Essay	11 x 14
Elver	6 x 10	Estat	11 x 15
Email	6 x 11	Ester	11 x 16
Emang	6 x 12	Estoc	11 x 17
Embar	6 x 13	Estre	11 x 18
Embla	6 x 14	Etaac	11 x 19
Embog	6 x 15	Ethal	11 x 20
Embry	6 x 16	Ether	12 x 12
Emeer	7 x 7	Ethic	12 x 13
Emend	7 x 8	Ethos	12 x 14
Emmet	7 x 9	Ettie	12 x 15
Emony	7 x 10	Etude	12 x 16
Empty	7 x 11	Eurus	12 x 17
Emrod	7 x 12	Evade	12 x 18
Enact	7 x 13	Event	12 x 19
Enage	7 x 14	Evict	12 x 20

### Hand of Saws.

Fable.....Right Hand      Facer.....Left Hand

### Number of Teeth.

Facie	4 teeth.	Fetch	58 teeth.
Fadge	6 teeth.	Fetor	60 teeth.
Faggy	8 teeth.	Fever	62 teeth.
Fagot	10 teeth.	Fibre	64 teeth.
Fagus	12 teeth.	Fiend	66 teeth.
Faham	14 teeth.	Fiery	68 teeth.
Fairy	16 teeth.	Filch	70 teeth.
Faint	18 teeth.	Filet	72 teeth.
Faith	20 teeth.	Filly	74 teeth.
Faise	22 teeth.	Filum	76 teeth.
Fancy	24 teeth.	Final	78 teeth.
Fanon	26 teeth.	Finch	80 teeth.
Farad	28 teeth.	Finis	82 teeth.
Farce	30 teeth.	Finit	84 teeth.
Faren	32 teeth.	Fenny	86 teeth.
Fasel	34 teeth.	Firth	88 teeth.
Fatal	36 teeth.	Fitch	90 teeth.
Fauld	38 teeth.	Flail	92 teeth.
Favel	40 teeth.	Flake	94 teeth.
Feast	42 teeth.	Flank	96 teeth.
Fecces	44 teeth.	Flash	98 teeth.
Feign	46 teeth.	Flaxy	100 teeth.
Felon	48 teeth.	Fleak	110 teeth.
Fenks	50 teeth.	Fletz	120 teeth.
Feoff	52 teeth.	Flier	130 teeth.
Ferny	54 teeth.	Fling	140 teeth.
Fetal	56 teeth.	Flirt	150 teeth.

### Number of Teeth—Cont'd.

Float	160 teeth.	Foggy	44 to 50.
Flock	170 teeth.	Foist	46 to 52.
Flown	180 teeth.	Fonde	48 to 54.
Fluff	30 to 36.	Foray	50 to 56.
Fluid	32 to 38.	Forté	52 to 58.
Flush	34 to 40.	Forum	54 to 60.
Flute	36 to 42.	Fount	56 to 62.
Flyer	38 to 44.	Foyne	58 to 64.
Focal	40 to 46.	Frack	60 to 66.
Focus	42 to 48.		

### Point to Point

Frill	1/4 inch.	Funny	1 1/4 inch.
Frisk	3/8 inch.	Funge	2 inches.
Frith	1/2 inch.	Furll	2 1/4 inches.
Fudge	1 inch.	Futsy	2 1/2 inches.
Fugie	1 1/4 inch.	Fyord	2 3/4 inches.
Furry	1 1/2 inch.	Fyldé	3 inches.
Funic	1 1/2 inch.		

### Diameter of Holes

Gabby .....Standard mandrel and pin holes.

### Mandrel Holes.

Gadhi	1/4 inch.	Gliint	2 in. full.
Gaily	3/8 inch.	Globy	2-in. scant.
Galea	1/2 inch.	Glare	2 1/8 inch.
Gamba	5/8 inch.	Glory	2 1/4 inch.
Garum	3/4 inch.	Glove	2 3/8 inch.
Gaudy	7/8 inch.	Glump	2 1/2 inch.
Gavel	1 1/8 inch.	Gnasp	2 1/4 inch.
Gawky	1 inch.	Gnome	2 3/8 inch.
Geist	1 1/8 inch.	Graff	2 1/2 inch.
Gelid	1 1/4 inch.	Grail	2 1/2 inch.
Gemel	1 1/8 inch.	Grape	2 1/4 inch.
Gemma	1 1/4 inch.	Greet	2 1/2 inch.
Gemot	1 1/8 inch.	Gride	2 1/4 inch.
Gcnet	1 1/4 inch.	Grief	2 1/4 inch.
Genie	1 1/8 inch.	Grill	2 1/4 inch.
Genus	1 1/2 inch.	Grive	2 1/4 inch.
Geode	1 1/8 inch.	Groin	2 1/4 inch.
Gerne	1 1/4 inch.	Grope	3 inch.
Ghost	1 1/4 inch.	Groom	3 1/2 inch.
Gilet	1 3/4 inch.	Growl	4 inch.
Glace	1 1/4 inch.	Guara	4 1/2 inch.
Glady	1 1/2 inch.	Guile	5 inch.
Gland	1 1/4 inch.	Guird	5 1/2 inch.
Glick	2-in. even.	Gumps	6 inch.

### Pin Holes.

Habit	1/8 inch.	Hauat	1/2 inch.
Haler	1/4 inch.	Haven	3/8 inch.
Hamal	1/2 inch.	Hawse	3/4 inch.
Hanse	3/8 inch.	Hazel	7/8 inch.
Hatch	3/4 inch.	Heave	1 1/8 inch.
Haulm	7/8 inch.	Heazy	1 inch.
Haten	Distance from center to center, inches.		

### Chisel Bit Polders and Teeth.

Pattern.		Pattern.	
Hedge	No. A.	Hocus	No. D D.
Heigh	No. B.	Hodge	No. 5.
Hemic	No. C.	Hoker	No. 4.
Hewer	No. D.	Holly	No. 3.
Hinch	No. A A.	Honey	No. 2.
Hoard	No. B B.	Hooch	Short Holder.
Hobby	No. C C.		

### Width of Point of Chisel Bit Teeth.

Icche	1/8 inch.	Index	1 1/2 inch.
Ichor	1/4 inch.	Indin	1 1/4 inch.
Ictus	3/8 inch.	Indue	1 1/4 inch.
Ideal	1/2 inch.	Inert	1 1/4 inch.
Idiot	3/4 inch.	Infer	1 1/4 inch.
Idler	1 inch.	Inhex	1 1/4 inch.
Iglou	1 1/8 inch.	Iniad	1 1/4 inch.
Ileum	1 1/4 inch.	Inkle	1 1/4 inch.
Imago	1 1/2 inch.	Inlet	1 1/4 inch.
Imide	1 1/2 inch.	Immid	1 1/4 inch.
Impar	1 1/4 inch.	Inovo	1 1/4 inch.
Inane	1 1/4 inch.	Irian	1 1/4 inch.
Incle	1 1/2 inch.		



**Shingle Machines.**

Jacal	Challoner's Hand Feed Machine.
Jacky	Challoner's Double Block Machine.
Jager	Challoner's Ten Block Machine.
Jalec	Perkins Grand Mogul.
Jamba	Perkins Columbia.
Jaunt	Perkins Michigan Favorite.
Javel	Perkins Perfection.
Jawed	Trevor Machine.
Jazel	Chase Machine.
Jelly	Greenwood Machine.
Jerky	Flynn Machine.
Jewel	Lane's Machine.
Jifty	Novelty No. 3 Machine.
Jippo	Novelty No. 4 Machine.
Joker	Buckeye Hall's Patent.
Joule	Dunbar.
Jubha	Mitchell Clipper.
Judge	Letson & Burpee.
Jugal	Saw Only, No Flange.
Jugum	Saw and New Flange Complete.
Juice	Saw to be Fitted to Old Flange.
Julep	Templet by Mail.

**Diameter of Flanges.**

Kalan	16 inches.	Kedge	24 inches.
Kalpa	18 inches.	Keech	25 inches.
Kambu	20 inches.	Kelis	26 inches.
Kapok	21½ inches.	Ketch	27 inches.
Karat	22 inches.	Ketol	28 inches.

**Feed.**

Keyel	1 inch.	Kithe	5 inches.
Keyed	1½ inch.	Kitty	6 inches.
Kiace	2 inches.	Kiver	7 inches.
Kieve	2½ inches.	Klang	8 inches.
Kilts	3 inches.	Kloof	9 inches.
Kinch	3½ inches.	Knack	10 inches.
Kirle	4 inches.	Knave	11 inches.
Kitar	4½ inches.	Knell	12 inches.

**Kind of Dress.**

Knick	Spring Set.
Knoll	Spread or Swage Set.

**Kind of Timber.**

Knout	Hardwood.	Kotow	Hemlock.
Knowl	Softwood.	Kreel	Fir.
Knuff	Norway Pine.	Krore	Redwood.
Knurl	Yellow Pine.	Kukri	All Kinds of
Kokil	Hickory.		Timber.

**Length.**

Labor	3 inches	Leger	16 feet.
Lache	4 inches	Leggy	17 feet.
Ladie	6 inches	Leman	18 feet.
Lagre	8 inches	Lemma	19 feet.
Laith	9 inches	Lends	20 feet.
Lakin	1 foot.	Lente	21 feet.
Lamba	2 feet.	Lepal	22 feet.
Lanky	3 feet.	Lepra	23 feet.
Lapis	3½ feet.	Lerry	24 feet.
Larch	4 feet.	Leste	25 feet.
Lardy	4½ feet.	Letch	26 feet.
Larix	5 feet.	Leton	27 feet.
Laser	5½ feet.	Leuch	28 feet.
Lasso	6 feet.	Leurie	29 feet.
Lates	6½ feet.	Leafy	30 feet.
Laus.	7 feet.	Levee	31 feet.
Lavic	7½ feet.	Levin	32 feet.
Lawny	8 feet.	Lewan	33 feet.
Lazar	8½ feet.	Lewth	34 feet.
Leach	9 feet.	Libel	35 feet.
Leaky	9½ feet.	Lichi	36 feet.
Learn	10 feet.	Licit	37 feet.
Lease	10½ feet.	Lifen	38 feet.
Leddy	11 feet.	Ligan	39 feet.
Leder	12 feet.	Likes	40 feet.
Ledge	13 feet.	Liman	41 feet.
Leful	14 feet.	Limbo	42 feet.
Legal	15 feet.	Limes	43 feet.

**Length—Cont'd.**

Limps	44 feet.	Loris	82 feet.
Linch	45 feet.	Lorry	83 feet.
Linen	46 feet.	Lorum	84 feet.
Lingo	47 feet.	Loser	85 feet.
Lippy	48 feet.	Lotah	86 feet.
Lisps	49 feet.	Loter	87 feet.
Lisse	50 feet.	Lothe	88 feet.
Litel	51 feet.	Loupe	89 feet.
Lithe	52 feet.	Loves	90 feet.
Litui	53 feet.	Lowan	91 feet.
Lived	54 feet.	Lowly	92 feet.
Livar	55 feet.	Lozel	93 feet.
Livid	56 feet.	Lucid	94 feet.
Loach	57 feet.	Lucky	95 feet.
Loans	58 feet.	Lucre	96 feet.
Loath	59 feet.	Lulla	97 feet.
Lobar	60 feet.	Lummy	98 feet.
Lobby	61 feet.	Lumps	99 feet.
Lobed	62 feet.	Lunar	100 feet.
Lobus	63 feet.	Lunch	105 feet.
Local	64 feet.	Lunda	110 feet.
Locks	65 feet.	Lunet	115 feet.
Locus	66 feet.	Lunge	120 feet.
Lodge	67 feet.	Lüpn	125 feet.
Loess	68 feet.	Luppa	130 feet.
Loffe	69 feet.	Lupus	135 feet.
Lofty	70 feet.	Lucres	140 feet.
Logan	71 feet.	Lurks	145 feet.
Logic	72 feet.	Lusty	150 feet.
Lokao	73 feet.	Lutes	200 feet.
Lolly	74 feet.	Lyart	300 feet.
Looby	75 feet.	Lycee	400 feet.
Loover	76 feet.	Lydin	500 feet.
Loony	77 feet.	Lymph	600 feet.
Lourd	78 feet.	Lynch	700 feet.
Loppy	79 feet.	Lynde	800 feet.
Loral	80 feet.	Lynde	900 feet.
Lorer	81 feet.	Lyric	1000 feet.

**Width.**

Mabby	1/8	Merge	18
Macaw	1/8	Merit	19
Macer	1/4	Mesad	20
Macle	3/8	Meshy	21
Macho	1/2	Metif	22
Madam	5/8	Metra	23
Madge	3/4	Midst	24
Madly	7/8	Milky	25
Mahoe	1	Mimic	26
Maize	1 1/8	Mince	27
Major	1 1/4	Minor	28
Makwa	1 1/2	Minus	29
Malty	2	Mirth	30
Malwa	2 1/4	Mitty	31
Mammy	2 1/2	Mizer	32
Manas	2 3/4	Molar	33
Maneh	3	Molly	34
Mango	3 1/4	Monad	35
Mania	3 1/2	Monte	36
Manse	3 3/4	Moody	37
Manor	4	Moose	38
Manta	4 1/4	Mopus	39
Marge	4 1/2	Moral	40
Marsh	4 3/4	Moria	41
Marum	5	Morse	42
Marry	5 1/4	Mosca	43
Masha	5 1/2	Mossy	44
Mason	5 3/4	Mothy	45
Massy	6	Moton	46
Matai	6 1/2	Motto	47
Mates	7	Mound	48
Matsu	7 1/2	Mourn	49
Matte	8	Mouse	50
Maund	8 1/2	Mover	51
Mauve	9	Mucin	52
Mawky	9 1/2	Mucus	53
Maxim	10	Muggy	54
Mazer	11	Mulse	55
Meach	12	Mumps	56
Mealy	13	Mural	57
Medal	14	Murex	58
Media	15	Musad	59
Meiee	16	Music	60
Meion	17		



<b>Number.</b>	
Nabit.....	0
Nabob.....	1
Nacre.....	2
Nader.....	3
Naggy.....	4
Naive.....	5
Naked.....	6
Nakir.....	7
Namaz.....	8
Namer.....	9
Nanga.....	10
Nanmu.....	11
Napal.....	12
Nappy.....	13
Nares.....	14
Narre.....	15
Nasal.....	16
Nasus.....	17
Nates.....	18
Nauch.....	19
Nazir.....	20
Nebby.....	21
Nebel.....	22
Needy.....	23
Neigh.....	24
Nerve.....	25
Newly.....	26
Nexal.....	27
Niata.....	28
Nihil.....	29
Nippy.....	30
Noisy.....	31
Nomic.....	32
Noose.....	33
Nopal.....	34
Nopap.....	35

<b>Quantity.</b>	
Paard.....	1
Pacer.....	2
Pacha.....	3
Padat.....	4
Paddy.....	5
Pagan.....	6
Page.....	7
Pagle.....	8
Paint.....	9
Palas.....	10
Palla.....	11
Palla.....	12
Palms.....	13
Palpi.....	14
Palsy.....	15
Pance.....	16
Pandy.....	17
Paned.....	18
Pangs.....	19
Panic.....	20
Pants.....	21
Paper.....	22
Pappy.....	23
Parch.....	24
Parcel.....	25
Parka.....	26
Parle.....	27
Parry.....	28
Parst.....	29
Party.....	30
Pasan.....	31
Pasch.....	32
Pasha.....	33
Paspy.....	34
Passe.....	35
Pasty.....	36
Patas.....	37
Paten.....	38
Patio.....	39
Patly.....	40
Pat.....	41
Pause.....	42
Pavas.....	43
Pavon.....	44
Pawed.....	45
Payer.....	46
Peach.....	47
Pearl.....	48
Pease.....	49
Peaty.....	50
Pecan.....	60
Pecul.....	70
Pedal.....	75
Pedes.....	80
Pedro.....	90
Pedum.....	100
Peeps.....	125
Peery.....	150
Peggy.....	175
Peine.....	200
Pekeo.....	225
Pelts.....	250
Pelma.....	275
Penai.....	300
Perce.....	325
Penna.....	350
Peony.....	375
Perch.....	400
Perdu.....	450
Perge.....	500
Peril.....	550
Pesky.....	600
Petal.....	650
Peter.....	700
Peths.....	750
Petit.....	800
Petty.....	850
Pewit.....	900
Phase.....	950
Pheer.....	1,000
Pheno.....	1,100
Phial.....	1,200
Phoca.....	1,300
Phone.....	1,400
Photo.....	1,500
Phren.....	1,600
Phyla.....	1,700
Physy.....	1,800
Piaga.....	1,900
Piano.....	2,000
Picot.....	2,500
Picra.....	3,000
Piend.....	3,500
Pilar.....	4,000
Piles.....	4,500
Pilot.....	5,000
Pilum.....	5,500
Pimel.....	6,000
Pinax.....	6,500
Pinch.....	7,000
Piney.....	7,500
Pinky.....	8,000
Pinna.....	8,500
Pinto.....	9,000
Pipal.....	9,500
Pipet.....	10,000
Pique.....	1 dozen
Pirol.....	2 dozen
Pirry.....	3 dozen
Pisky.....	4 dozen
Plaga.....	5 dozen
Plaid.....	6 dozen
Plash.....	7 dozen
Plaza.....	8 dozen
Plead.....	9 dozen
Plebs.....	10 dozen
Pleon.....	11 dozen
Pluck.....	12 dozen
Plume.....	14 dozen
Plyer.....	16 dozen
Poach.....	18 dozen
Poddy.....	20 dozen
Poise.....	25 dozen
Poker.....	30 dozen
Polar.....	35 dozen
Polly.....	40 dozen
Pombe.....	45 dozen
Pongo.....	50 dozen
Popit.....	60 dozen
Poppy.....	70 dozen

<b>Quantity—Cont'd.</b>	
Porro.....	75 dozen
Posca.....	80 dozen
Posse.....	90 dozen
Pouch.....	100 dozen
Prank.....	150 dozen
Prays.....	200 dozen
Press.....	250 dozen
Pride.....	300 dozen
Prime.....	350 dozen
Prink.....	400 dozen
Prior.....	450 dozen
Probe.....	500 dozen
Proem.....	750 dozen

### Cross-Cut Saws.

Prosy.....	Pacific Coast pattern cut to ends
Prune.....	Silver-Steel
Psalm.....	Special Steel
Puffy.....	Segment Ground

### Styles of Tooth.

Rabat.....	Silver-Steel Diamond
Rabbi.....	Silver-Steel Dexter
Rabid.....	Rex, Pennsylvania Pattern
Racer.....	Rex, Perforated
Radad.....	Peerless
Rache.....	Perfection
Rajak.....	No. 1 Perfection
Rakol.....	No. 2 Perfection
Ralam.....	No. 3 Perfection
Rapod.....	No. 4 Perfection
Radix.....	Hemlock King
Rainy.....	Dexter, 14 x 16 Gauge
Rally.....	Dexter, 14 x 18 Gauge
Rampe.....	Dexter, 14 x 19 Gauge
Raspe.....	Moss Back Lance Tooth not perforated
Rater.....	Moss Back Lance Tooth perforated
Ravel.....	Moss Back Tuttle Tooth perforated
Razor.....	Moss Back Tuttle Tooth not perforated
React.....	Victor Lance Tooth perforated
Reaks.....	Lance Tooth
Realm.....	Diamond, 14 x 16 Gauge
Rebel.....	Diamond, 14 x 18 Gauge
Rebus.....	Lone Star
Redan.....	Tuttle Tooth, 14 x 16 Gauge
Redif.....	Tuttle Tooth, 14 x 18 Gauge
Redly.....	Tuttle Tooth, 14 x 19 Gauge
Redmo.....	Hummer
Reefy.....	Matchless, 14 x 19 Gauge (Segment Ground)
Reesk.....	Matchless, 14 x 18 Gauge
Reeve.....	One-Man Matchless
Regal.....	Hollow Back Matchless
Reges.....	Improved Universal
Regop.....	Hollow Back Improved Universal
Reina.....	American, 14 x 16 Gauge
Relax.....	American, 14 x 18 Gauge
Relet.....	Common, 14 x 16 Gauge
Relic.....	Common, 14 x 18 Gauge
Renne.....	Feather Edge, 14 x 18 Gauge
Repel.....	Hickory, 14 x 16 Gauge
Resin.....	Electric, 14 x 16 Gauge
Rheic.....	Electric, 14 x 18 Gauge
Rhime.....	Sheffield, 14 x 16 Gauge
Rhumb.....	Sheffield, 14 x 18 Gauge
Riata.....	Single Hook, 14 x 16 Gauge
Rifle.....	Single Hook, 14 x 18 Gauge
Rimer.....	Double Hook, 14 x 16 Gauge
Rinse.....	Double Hook, 14 x 18 Gauge
Ripen.....	Rex, Falling Saw
Risel.....	Perfection Tooth "Rex" Falling Saw
Risky.....	Hollow Back American
Risus.....	Hollow Back Victor
Rithe.....	One-Man Cedar King
Roach.....	One-Man Tuttle
Roams.....	One-Man American
Robin.....	One-Man American Skew Back
Rocky.....	One-Man Victor
Rocta.....	One-Man Diamond
Roddy.....	One-Man Saws. Silver-Steel
Roily.....	One-Man No. 1 Handle
Roint.....	One-Man No. 2 Handle
Rompt.....	Pacifico (Coast Pattern)
Ronin.....	Worden (Coast Pattern)
Roody.....	Tyer (Coast Pattern)
Roost.....	Dexter (Coast Pattern)
Rotor.....	Clincher (Coast Pattern)
Rough.....	Redwood King (Coast Pattern)
Roule.....	Redwood Falling Saw (Coast Pattern)
Roupy.....	Star of the West (Coast Pattern)
Routh.....	Pacific Star (Coast Pattern)



# — ATKINS SILVER STEEL SAWS —

## Styles of Tooth—Cont'd.

Rowdy.....	Howatson (Coast Pattern)
Rowel.....	Perfection (Coast Pattern)
Rowme.....	Victor (Coast Pattern)
Ruach.....	Lance Tooth (Coast Pattern)
Rubin.....	Diamond (Coast Pattern)
Ruble.....	Tuttle, (Coast Pattern)
Ruche.....	Auckland Pattern, No. 15
Rudey.....	Auckland Pattern, No. 7
Rudgy.....	Auckland Pattern, No. 8
Ruffy.....	Auckland Pattern, No. 9
Ruing.....	Auckland Pattern, No. 10
Rumal.....	Tasmanian Pattern
Rummy.....	Russian Pattern

## Cross-Cut Saw Handles.

Saber.....	No. 1	pattern
Sable.....	No. 2	pattern
Sabot.....	No. 3	pattern
Sacar.....	No. 4	pattern
Sadly.....	No. 5	pattern
Saffo.....	No. 6	pattern
Saiga.....	No. 7	pattern
Sairy.....	No. 8	pattern
Salad.....	No. 9	pattern
Salin.....	No. 10	pattern
Salop.....	No. 11	pattern
Salse.....	No. 12	pattern
Salty.....	No. 13	pattern
Sambo.....	No. 13x	pattern
Sanat.....	No. 14	pattern
Sandy.....	No. 15	pattern
Sangu.....	No. 16	pattern
Sapor.....	No. 17	pattern
Sargo.....	No. 18	pattern
Sarre.....	No. 19	pattern
Sasin.....	No. 20	pattern
Satin.....	No. 21	pattern
Sauce.....	No. 22	pattern
Savey.....	No. 23	pattern
Savor.....	No. 24	pattern
Saxon.....	No. 25	pattern
Schol.....	No. 26	pattern
Sogud.....	No. 108	pattern
Sofin.....	No. 111	pattern

## Cross-Cut and Hand Saw Tools.

Sayon.....	Excelsior No. 1
Scala.....	Excelsior No. 2
Skido.....	Excelsior, Nickel Plate
Scalp.....	Perfection
Scamp.....	Rex
Scant.....	Dexter
Sadel.....	Ideal
Scath.....	Leader
Scars.....	Single Raker Gauges
Scaup.....	Double Raker Gauges
Scene.....	Improved Criterion Saw Set
Scion.....	Criterion Band Saw Set
Scoff.....	Hammer for Setting Saws
Scrim.....	Channelling Set Block
Scrub.....	Lever Saw Set
Sculp.....	Raker Swage
Scurf.....	Perfect Saw Set
Scary.....	Perfect Saw Set and Vise
Sebum.....	Wilson Saw Filer

## Hand Saws.

Seely.....	No. 51	Shaky.....	No. 65
Segue.....	No. 52	Shama.....	No. 66
Seity.....	No. 53	Shand.....	No. 67
Sendo.....	No. 54	Shark.....	No. 68
Sense.....	No. 55	Shawl.....	No. 69
Sepia.....	No. 56	Shear.....	No. 70
Serpe.....	No. 57	Sheek.....	No. 71
Serin.....	No. 58	Shiel.....	No. 72
Serry.....	No. 59	Shift.....	No. 73
Sessa.....	No. 60	Shine.....	No. 74
Setce.....	No. 61	Shirl.....	No. 76
Sewer.....	No. 62	Shoal.....	No. 83
Shade.....	No. 63	Shock.....	No. 84
Shail.....	No. 64	Shole.....	No. 86

## Hand Saws—Cont'd.

Shute.....	No. 93	Shust.....	No. 99
Shure.....	No. 94	Shoot.....	No. 400
Shupy.....	No. 96	Showy.....	No. 401
Shrew.....	32-inch Rip Saw		
Shrub.....	30-inch Rip Saw		
Shurf.....	28-inch Rip Saw		
Silior.....	26-inch Rip Saw		
Siege.....	26-inch Hand Saw		
Silky.....	28-inch Hand Saw		
Sinew.....	30-inch Hand Saw		
Singe.....	24-inch Panel Saw		
Sipid.....	22-inch Panel Saw		
Siren.....	20-inch Panel Saw		
Sirup.....	18-inch Panel Saw		
Sissy.....	16-inch Panel Saw		
Skein.....	14-inch Panel Saw		

## Points to the Inch.

Skink.....	1 point to inch	( 1 tooth to the inch)
Skirt.....	2 points to inch	( 2 teeth to the inch)
Slack.....	3 points to inch	( 3 teeth to the inch)
Slave.....	4 points to inch	( 4 teeth to the inch)
Sleds.....	5 points to inch	( 5 teeth to the inch)
Sleep.....	6 points to inch	( 6 teeth to the inch)
Slime.....	7 points to inch	( 7 teeth to the inch)
Sliit.....	8 points to inch	( 8 teeth to the inch)
Slued.....	9 points to inch	( 9 teeth to the inch)
Slump.....	10 points to inch	(10 teeth to the inch)
Slush.....	11 points to inch	(11 teeth to the inch)
Slyly.....	12 points to inch	(12 teeth to the inch)

## Dollars.

Tabby.....	\$1.00	Thole.....	\$51.00
Tabes.....	2.00	Thyme.....	52.00
Taboo.....	3.00	Tibia.....	53.00
Tabut.....	4.00	Tidal.....	54.00
Tache.....	5.00	Tiddy.....	55.00
Tacit.....	6.00	Tiler.....	56.00
Tacky.....	7.00	Tinca.....	57.00
Taffy.....	8.00	Tinea.....	58.00
Tagma.....	9.00	Tinge.....	59.00
Taint.....	10.00	Tinty.....	60.00
Taien.....	11.00	Title.....	61.00
Talky.....	12.00	Toast.....	62.00
Taluk.....	13.00	Token.....	63.00
Talus.....	14.00	Tonal.....	64.00
Tambo.....	15.00	Tonga.....	65.00
Tamer.....	16.00	Tonic.....	66.00
Tamus.....	17.00	Topia.....	67.00
Tangy.....	18.00	Torso.....	68.00
Tanha.....	19.00	Torus.....	69.00
Tapis.....	20.00	Toter.....	70.00
Tardy.....	21.00	Totty.....	71.00
Taree.....	22.00	Touch.....	72.00
Tarse.....	23.00	Towar.....	73.00
Taste.....	24.00	Towse.....	74.00
Tauga.....	25.00	Toyon.....	75.00
Taunt.....	26.00	Trabs.....	76.00
Tawny.....	27.00	Track.....	77.00
Taxis.....	28.00	Traik.....	78.00
Tazel.....	29.00	Tramp.....	79.00
Teach.....	30.00	Trash.....	80.00
Teals.....	31.00	Trays.....	81.00
Tease.....	32.00	Tread.....	82.00
Tecum.....	33.00	Treen.....	83.00
Teens.....	34.00	Tribe.....	84.00
Telar.....	35.00	Trick.....	85.00
Telic.....	36.00	Trims.....	86.00
Temse.....	37.00	Trist.....	87.00
Tench.....	38.00	Troll.....	88.00
Tendo.....	39.00	Trout.....	89.00
Tenet.....	40.00	Truss.....	90.00
Tenia.....	41.00	Truth.....	91.00
Tenor.....	42.00	Tufty.....	92.00
Tense.....	43.00	Tumid.....	93.00
Terin.....	44.00	Turba.....	94.00
Terma.....	45.00	Turfy.....	95.00
Terza.....	46.00	Turps.....	96.00
Testa.....	47.00	Tutor.....	97.00
Teyne.....	48.00	Twang.....	98.00
Theak.....	49.00	Twill.....	99.00
Thein.....	50.00	Twine.....	100.00



## NUMERICAL CODE.

### EXPLANATION.

There are 1,000 words listed herewith. Each word is numbered consecutively from 1 to 1,000 and each word begins with the letter "M." So that if you have occasion to use any number less than 1,000, you have merely to use the code word opposite that number.

If you wish to use a number above 1,000, use the same word except change the initial letter as follows:

- For numbers from 1001 to 2000 inclusive use the initial N instead of M.
- For numbers from 2001 to 3000 inclusive use the initial P instead of M.
- For numbers from 3001 to 4000 inclusive use the initial R instead of M.
- For numbers from 4001 to 5000 inclusive use the initial S instead of M.
- For numbers from 5001 to 6000 inclusive use the initial T instead of M.
- For numbers from 6001 to 7000 inclusive use the initial V instead of M.
- For numbers from 7001 to 8000 inclusive use the initial W instead of M.
- For numbers from 8001 to 9000 inclusive use the initial Y instead of M.
- For numbers from 9001 to 10000 inclusive use the initial Z instead of M.

This, you see, enables you to use any number between 1 and 10,000, which is as high a figure as you will likely have occasion to use.

### FOR EXAMPLE.

- For No. 1001 the word would be Nabab.
- For No. 2100 the word would be Pabuy.
- For No. 3168 the word would be Radkf.
- For No. 4444 the word would be Shaft.
- For No. 5561 the word would be Tajip.
- For No. 6650 the word would be Vakgy.
- For No. 7795 the word would be Wamug.
- For No. 8905 the word would be Yaqag.
- For No. 9999 the word would be Zaqux.

1 Mabab	58 Mablk	115 Madas	172 Madma	229 Mafdi	286 Mafox	343 Magfr
2 Mabac	59 Mabim	116 Madat	173 Madmn	230 Mafdo	287 Mafpa	344 Magft
3 Mabad	60 Mabin	117 Madau	174 Madmu	231 Mafds	288 Mafra	345 Magfu
4 Mabaf	61 Mabip	118 Madav	175 Madng	232 Mafed	289 Mafrm	346 Magfy
5 Mabag	62 Mabiq	119 Madaw	176 Madns	233 Mafej	290 Mafrn	347 Maggn
6 Mabah	63 Mabis	120 Madax	177 Madnu	234 Mafek	291 Mafu	348 Maggn
7 Mabaj	64 Mabit	121 Maday	178 Madnx	235 Mafen	292 Mafsa	349 Maggu
8 Mabak	65 Mabiw	122 Madaz	179 Madog	236 Mafeq	293 Mafuc	350 Maggy
9 Mabal	66 Mamiw	123 Madca	180 Madom	237 Mafef	294 Mafud	351 Magia
10 Mabam	67 Mabix	124 Madce	181 Madon	238 Mafes	295 Mafug	352 Magib
11 Mabab	68 Mabkf	125 Madck	182 Madop	239 Mafew	296 Mafun	353 Magid
12 Mabap	69 Mabko	126 Madcm	183 Mador	240 Mafex	297 Mafur	354 Magif
13 Mabaq	70 Mabku	127 Madcs	184 Mados	241 Maffa	298 Mafus	355 Magig
14 Mabar	71 Mabky	128 Madcu	185 Madou	242 Mafn	299 Mafux	356 Magih
15 Mabas	72 Mabma	129 Maddi	186 Madox	243 Maftr	300 Mafuy	357 Magij
16 Mabab	73 Mabmn	130 Maddo	187 Madpa	244 Mafu	301 Magab	358 Magik
17 Mabau	74 Mabmu	131 Madds	188 Madra	245 Mafu	302 Magac	359 Magim
18 Mabav	75 Mabng	132 Maded	189 Madrm	246 Mafy	303 Magad	360 Magin
19 Mabaw	76 Mabns	133 Madej	190 Madrn	247 Mafgm	304 Magaf	361 Magip
20 Mabax	77 Mabnu	134 Madek	191 Madru	248 Mafgn	305 Magag	362 Magiq
21 Mabay	78 Mabnx	135 Maden	192 Madsa	249 Mafgu	306 Magah	363 Magis
22 Mabaz	79 Mabog	136 Madeq	193 Madue	250 Mafgy	307 Magaj	364 Magit
23 Mabca	80 Mabom	137 Mader	194 Madud	251 Mafia	308 Magak	365 Magiu
24 Mabce	81 Mabon	138 Mades	195 Madug	252 Mafif	309 Magal	366 Magiw
25 Mabck	82 Mabop	139 Madew	196 Madun	253 Mafid	310 Magarr	367 Magix
26 Mabcm	83 Mabob	140 Madex	197 Madur	254 Mafif	311 Magan	368 Magkf
27 Mabcs	84 Mabos	141 Madfa	198 Madus	255 Mafig	312 Magap	369 Magko
28 Mabcu	85 Mabou	142 Madfn	199 Madux	256 Mafih	313 Magaq	370 Magku
29 Mabd	86 Mabox	143 Madfr	200 Maduy	257 Mafij	314 Magar	371 Magky
30 Mabda	87 Mabpa	144 Madft	201 Mafab	258 Mafik	315 Magas	372 Magma
31 Mabd	88 Mabra	145 Madfu	202 Mafac	259 Mafim	316 Magat	373 Magmn
32 Mabd	89 Mabrm	146 Madfy	203 Mafad	260 Mafin	317 Magau	374 Magmu
33 Mabef	90 Mabrn	147 Madgm	204 Mafaf	261 Mafip	318 Magav	375 Magng
34 Mabek	91 Mabru	148 Madgn	205 Mafag	262 Mafiq	319 Magaw	376 Magns
35 Mabem	92 Mabsa	149 Madgu	206 Mafah	263 Mafis	320 Magax	377 Magnu
36 Mabeg	93 Mabuc	150 Madgy	207 Mafaj	264 Mafit	321 Magay	378 Magnx
37 Maber	94 Mabd	151 Madia	208 Mafak	265 Mafu	322 Magaz	379 Magog
38 Mabes	95 Mabug	152 Madib	209 Mafal	266 Mafiw	323 Magca	380 Magom
39 Mabew	96 Mabun	153 Madid	210 Mafam	267 Mafix	324 Magce	381 Magon
40 Mabex	97 Mabur	154 Madif	211 Mafan	268 Mafkf	325 Magck	382 Magop
41 Mabfa	98 Mabus	155 Madig	212 Mafap	269 Mafko	326 Magcm	383 Magor
42 Mabfn	99 Mabux	156 Madih	213 Mafaq	270 Mafku	327 Magcs	384 Magos
43 Mabfr	100 Mabuy	157 Madij	214 Mafar	271 Mafky	328 Magcu	385 Magou
44 Mabft	101 Madab	158 Madik	215 Mafas	272 Mafma	329 Magdi	386 Magox
45 Mabfu	102 Madac	159 Madim	216 Mafat	273 Mafmn	330 Magdo	387 Magpa
46 Mabfy	103 Madad	160 Madin	217 Mafau	274 Mafmu	331 Magds	388 Magra
47 Mabgm	104 Madaf	161 Madip	218 Mafav	275 Mafng	332 Maged	389 Magrm
48 Mabgn	105 Madag	162 Madiq	219 Mafaw	276 Mafns	333 Magej	390 Magrn
49 Mabgu	106 Madah	163 Madis	220 Mafax	277 Mafnu	334 Magek	391 Magru
50 Mabgy	107 Madaj	164 Madit	221 Mafay	278 Mafnx	335 Magen	392 Magsa
51 Mabia	108 Madak	165 Madiu	222 Mafaz	279 Mafog	336 Mageq	393 Maguc
52 Mabib	109 Madal	166 Madiw	223 Mafca	280 Mafom	337 Mager	394 Magud
53 Mabit	110 Madam	167 Madix	224 Mafce	281 Mafon	338 Mages	395 Magug
54 Mabif	111 Madan	168 Madkf	225 Mafck	282 Mafop	339 Magew	396 Magun
55 Mabig	112 Madap	169 Madko	226 Mafcm	283 Mafor	340 Magex	397 Magur
56 Mabih	113 Madaq	170 Madku	227 Mafcs	284 Mafos	341 Magfa	398 Magu
57 Mabit	114 Madar	171 Madky	228 Mafcu	285 Mafou	342 Magfn	399 Magux



400	Maguy	486	Mahox	572	Majma	658	Makik	744	Mamft	830	Mando	916	Maqat
401	Mahab	487	Mahpa	573	Majmn	659	Makim	745	Mamfu	831	Mandu	917	Maqav
402	Mahac	488	Mahra	574	Majmu	660	Makin	746	Mamfy	832	Maned	918	Maqav
403	Mahad	489	Mahrn	575	Majng	661	Makip	747	Mamgm	833	Manej	919	Maqaw
404	Mahaf	490	Mahrn	576	Majns	662	Makiq	748	Mamgn	834	Manek	920	Maqax
405	Mahag	491	Mahru	577	Majnu	663	Makis	749	Mamgu	835	Manen	921	Maqay
406	Mahah	492	Mahsa	578	Majnx	664	Makit	750	Mamgy	836	Maneq	922	Maqaz
407	Mahaj	493	Mahuc	579	Majog	665	Makiu	751	Mamia	837	Maner	923	Maqca
408	Mahak	494	Mahud	580	Majom	666	Makiw	752	Mamib	838	Manew	924	Maqce
409	Mahal	495	Mahug	581	Majon	667	Makix	753	Mamid	839	Manex	925	Maqck
410	Maham	496	Mahun	582	Majop	668	Makkf	754	Mamif	840	Manez	926	Maqcm
411	Mahan	497	Mahur	583	Majog	669	Makko	755	Mamig	841	Manfa	927	Maqcs
412	Mahap	498	Mahus	584	Majos	670	Makku	756	Mamih	842	Manfn	928	Maqcu
413	Mahaq	499	Mahux	585	Majou	671	Makky	757	Mamij	843	Manfr	929	Maqdi
414	Mahar	500	Mahuy	586	Majox	672	Makma	758	Mamik	844	Manft	930	Maqdo
415	Mahas	501	Majab	587	Majpa	673	Makmn	759	Mamim	845	Manfu	931	Maqdu
416	Mahat	502	Majac	588	Majra	674	Makmu	760	Mamin	846	Manfy	932	Maqed
417	Mahau	503	Majad	589	Majrn	675	Makng	761	Mamio	847	Mangm	933	Maqej
418	Mahav	504	Majaf	590	Majrn	676	Makns	762	Mamip	848	Mangn	934	Maqek
419	Mahaw	505	Majag	591	Majru	677	Maknu	763	Mamiq	849	Mangu	935	Maqen
420	Hahax	506	Majah	592	Majsa	678	Maknx	764	Mamit	850	Mangy	936	Maqeq
421	Mahay	507	Majaj	593	Majuc	679	Makog	765	Mamiu	851	Mania	937	Maqer
422	Mahaz	508	Majak	594	Majud	680	Makom	766	Mamiw	852	Manib	938	Maqes
423	Mahca	509	Majal	595	Majug	681	Makon	767	Mamix	853	Manid	939	Maqew
424	Mahce	510	Majam	596	Majun	682	Makop	768	Mamkf	854	Manif	940	Maqfx
425	Mahck	511	Majan	597	Majur	683	Makor	769	Mamko	855	Manig	941	Maqfa
426	Mahcm	512	Majap	598	Majus	684	Makos	770	Mamku	856	Manih	942	Maqfn
427	Mahcs	513	Majaq	599	Majux	685	Makou	771	Mamky	857	Manij	943	Maqfr
428	Mahcu	514	Majar	600	Majuy	686	Makox	772	Mammf	858	Manik	944	Maqft
429	Mahdi	515	Majas	601	Makab	687	Makpa	773	Mammn	859	Manim	945	Maqfu
430	Mahdo	516	Majat	602	Makac	688	Makra	774	Mammu	860	Manin	946	Maqfy
431	Mahdu	517	Majau	603	Makaf	689	Makrm	775	Mamng	861	Manip	947	Maqgm
432	Mahed	518	Majav	604	Makag	690	Makrn	776	Mamns	862	Maniq	948	Maqgn
433	Mahaj	519	Majaw	605	Makah	691	Makru	777	Mamnu	863	Manis	949	Maqgu
434	Mahak	520	Majax	606	Makaj	692	Maksa	778	Mamnx	864	Manit	950	Maqia
435	Mahen	521	Majay	607	Makak	693	Makuc	779	Mamog	865	Maniu	951	Maqia
436	Mahcq	522	Majaz	608	Makal	694	Makud	780	Mamor	866	Maniw	952	Maqib
437	Maher	523	Majca	609	Makam	695	Makug	781	Mamon	867	Manix	953	Maqid
438	Mahes	524	Majce	610	Makan	696	Makun	782	Mamor	868	Mankf	954	Maqif
439	Mahew	525	Majck	611	Makap	697	Makur	783	Mamop	869	Manko	955	Maqig
440	Hahex	526	Majcm	612	Makaq	698	Makus	784	Mamos	870	Manku	956	Maqih
441	Mahfa	527	Majcs	613	Makar	699	Makux	785	Mamou	871	Manky	957	Maqij
442	Mahfn	528	Majcu	614	Makas	700	Makuy	786	Mamox	872	Manma	958	Maqik
443	Mahfr	529	Majdi	615	Makat	701	Mamab	787	Mampa	873	Manmn	959	Maqim
444	Mahft	530	Majdo	616	Makau	702	Mamac	788	Mamra	874	Manng	960	Maqin
445	Mahfu	531	Majds	617	Makav	703	Mamad	789	Mamrm	875	Manng	961	Maqip
446	Mahfy	532	Majed	618	Makaw	704	Mamaf	790	Mamrn	876	Manns	962	Maqiq
447	Mahgm	533	Majej	619	Makax	705	Mamag	791	Mamru	877	Mannu	963	Maqis
448	Mahgn	534	Majek	620	Makay	706	Mamah	792	Mamsa	878	Mannx	964	Maqit
449	Mahgu	535	Majen	621	Makaz	707	Mamaj	793	Mamuc	879	Manog	965	Maqiu
450	Mahgy	536	Majeq	622	Makca	708	Mamak	794	Mamud	880	Manom	966	Maqiw
451	Mahia	537	Majer	623	Makce	709	Mamal	795	Mamug	881	Manon	967	Maqix
452	Mahib	538	Majes	624	Makef	710	Mamam	796	Mamun	882	Manop	968	Maqkf
453	Mahid	539	Majew	625	Makck	711	Maman	797	Mamur	883	Manor	969	Maqko
454	Mahif	540	Majex	626	Makcm	712	Mamap	798	Mamux	884	Manos	970	Maqku
455	Mahig	541	Majfa	627	Makes	713	Mamaq	799	Mamux	885	Manou	971	Maqky
456	Mahih	542	Majfn	628	Makcu	714	Mamar	800	Mamuy	886	Manox	972	Maqma
457	Mahij	543	Majfr	629	Makdi	715	Mamas	801	Manab	887	Manpa	973	Maqmn
458	Mahik	544	Majft	630	Makdo	716	Mamau	802	Manac	888	Manra	974	Maqmu
459	Mahim	545	Majfu	631	Makds	717	Mamav	803	Manad	889	Manrm	975	Maqng
460	Mahin	546	Majfy	632	Makeb	718	Mamaw	804	Manaf	890	Manrn	976	Maqnu
461	Mahip	547	Majgm	633	Makej	719	Mamax	805	Manag	891	Manru	977	Maqnx
462	Mahiq	548	Majgn	634	Makek	720	Mamay	806	Manah	892	Manse	978	Maqog
463	Mahis	549	Majgu	635	Maken	721	Mamaz	807	Manaj	893	Manuc	979	Maqom
464	Mahit	550	Majgy	636	Makeq	722	Mamca	808	Manak	894	Manud	980	Maqon
465	Mahiu	551	Majia	637	Maker	723	Mamee	809	Manal	895	Manug	981	Maqop
466	Mahiw	552	Majib	638	Makeu	724	Mamef	810	Manam	896	Manur	982	Maqor
467	Mahix	553	Majid	639	Makew	725	Mamek	811	Manan	897	Manur	983	Maqos
468	Mahkf	554	Majif	640	Makex	726	Mamcm	812	Manap	898	Manus	984	Maqou
469	Mahko	555	Majig	641	Makfa	727	Mames	813	Manaq	899	Manux	985	Maqox
470	Mahku	556	Majih	642	Makfr	728	Mameu	814	Manar	900	Manuy	986	Maqpa
471	Mahky	557	Majij	643	Makfn	729	Mamdi	815	Manas	901	Maqab	987	Maqra
472	Mahma	558	Majik	644	Makft	730	Mamdo	816	Manat	902	Maqac	988	Maqrm
473	Mahmn	559	Majim	645	Makfu	731	Mamds	817	Manau	903	Maqad	989	Maqrn
474	Mahmu	560	Majin	646	Makfy	732	Mameb	818	Manav	904	Maqaf	990	Maqru
475	Mahng	561	Majip	647	Makgm	733	Mamej	820	Manax	906	Maqah	992	Maqsa
476	Mahns	562	Majiq	648	Makgn	734	Mamek	821	Manay	907	Maqaj	993	Maqsy
477	Mahnu	563	Majis	649	Makgu	735	Mamen	822	Manaz	908	Maqak	994	Maquc
478	Mahnx	564	Majit	650	Makgy	736	Mameq	823	Manca	909	Maqal	995	Maqud
479	Mahog	565	Majlu	651	Makia	737	Mamer	824	Mance	910	Maqam	996	Maqug
480	Mahom	566	Majlw	652	Makib	738	Mameu	825	Manck	911	Maqan	997	Maqur
481	Mahon	567	Majlx	653	Makid	739	Mamew	826	Mancm	912	Maqap	998	Maqur
482	Mahop	568	Majkf	654	Makif	740	Mamex	827	Mancs	913	Maqaq	999	Maqux
483	Mahor	569	Majko	655	Makig	741	Mamfa	828	Mancu	914	Maqar	1000	Maquy
484	Mahos	570	Majku	656	Makih	742	Mamfn	829	Mandi	915	Maqas		
485	Mahou	571	Majky	657	Makij	743	Mamfr						



**ANALYTICAL DEPARTMENT.**

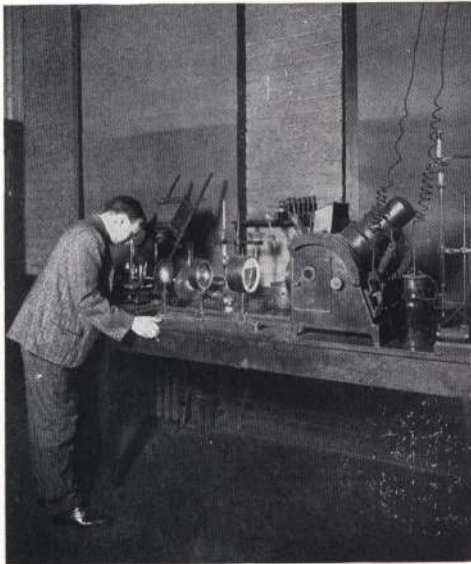

IN THE LABORATORY.

There is, perhaps, no product from metal that requires more exquisite handling from start to finish than does the Saw. We realize this fact, and in order to meet the condition, are maintaining a laboratory as complete as is possible to equip, under the care of specialists of recognized ability, training and experience.

Much of the success this Company has attained is directly due to the fact that a rigid physical, chemical and microscopical test has been maintained throughout each process of manufacture.

So thorough has been the organization in this department that we find ourselves able to do a limited amount of outside work. We offer, therefore, the same facilities that we ourselves enjoy, and have fixed a nominal rate of charge, much below that of exclusive laboratories who may have only a meager experience in this particular line.

**CHARGES FOR CHEMICAL ANALYSIS.**

**IRON, STEEL AND FERRO ALLOYS.**

Total Carbon by Combustion .....	\$0 75
Graphitic Carbon..	75
Manganese .....	75
Silicon .....	75
Sulphur.....	75
Phosphorus.....	75
Iron .....	2 00
Chromium .....	2 00
Tungsten .....	2 00
Titanium .....	2 00
Nickel .....	3 00
Tin .....	3 00
Antimony.....	3 00
Copper.....	3 00
Molybdenum .....	3 00
Slag and Oxides....	3 00
Arsenic .....	3 00
Cobalt.....	3 00
Vanadium.....	5 00

**ALLOYS AND INGOTS.**

Manganese.....	\$0 75
Antimony.....	1 50
Bismuth .....	1 50
Lead.....	1 50
Silver.....	1 50
Zinc.....	1 50
Iron .....	2 00
Arsenic.....	3 00
Molybdenum .....	3 00
Nickel.....	3 00
Copper.....	3 00
Cobalt.....	3 00
Tin .....	3 00

**WATER.**

**Sanitary Analysis.**

Albumenoid Ammonia..	} Total, \$10.00
Free Ammonia.....	
Chlorides.....	
Nitrites.....	
Nitrates.....	

**For Manufacturing Purposes.**

Each constituent found....	\$1 50
----------------------------	--------

**LIMESTONE, ORES, CLAYS AND CEMENTS.**

Volatile Matter ....	\$1 50
Silica.....	1 50
Alumina.....	1 50
Lime .....	1 50
Magnesia.....	1 50
Sulphuric Acid....	1 50
Carbonic Acid.....	1 50
Oxide of Iron.....	2 00
Potash.....	3 00
Soda.....	3 00
Other elements same as in steel and alloys.	

**COAL AND COKE.**

**Proximate Analysis.**

Moisture .....	\$0 75
Volatile Matter.....	75
Fixed Carbon.....	75
Ash .....	75
Silica.....	1 50
Sulphur.....	2 00
Phosphorus.....	2 00
Iron .....	2 00

## Atkins Circular Saws

Our long experience and knowledge of general requirements of users of saws in all sections and countries, enable us to make saws for the trade which will, as a rule, prove entirely satisfactory. The buyer should select the diameter and gauge best adapted for his work, and the kind of saw suited to his mill. The features of TEMPER and TENSION should be left entirely to the judgment of the maker. The Atkins saws seldom fail to give satisfaction in these respects, but if so, the trouble is FULLY COVERED by our warranty (see page 7).

Full stock of Saws of standard specifications are generally on hand at the home factory and branch houses, insuring as a rule, prompt service. Saws of unusual specifications have to be made to order and should therefore always be ordered as far ahead of actual requirement as possible. When sending orders please give us ALL information possible. In addition to the specifications noted, give your name, postoffice address, shipping address (if different), and state whether freight or express shipment is desired.

Each Saw is carefully tested in regard to temper and tension, and a record of all Saws are retained by us, so that we can at any time duplicate a Saw of our manufacture.



## INSTRUCTIONS FOR ORDERING CIRCULAR SAWS.

In ordering Circular Saws be careful to give following specifications in detail.

- (a) Diameter of saw in inches.
- (b) Right or left hand (see cut below.)
- (c) Gauge (thickness) of saw at center and also at rim.
- (d) Number of teeth in saw.
- (e) Style or pattern of tooth (see cut on following page.)
- (f) Diameter of mandrel hole; diameter of pin holes, and distance center to center of pin holes.
- (g) Number of revolutions of saw per minute WHILE IN CUT.
- (h) Greatest feed in inches per revolution—kind of feed.
- (i) Kind of timber sawed.
- (j) Spring or swage set.
- (k) For rip or cross-cut work.
- (l) Horse power available.

All our stock saws forty inches and larger in diameter have STANDARD mandrel and pin holes, namely—two-inch mandrel hole, and five-eighths lug pin holes, three inches from center to center. If wanted different, please send full pattern of holes. Order blanks furnished on application.

### HAND OF CIRCULAR SAWS.

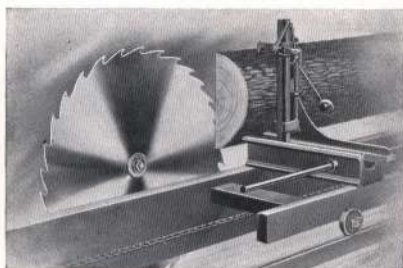

**Left Hand.**

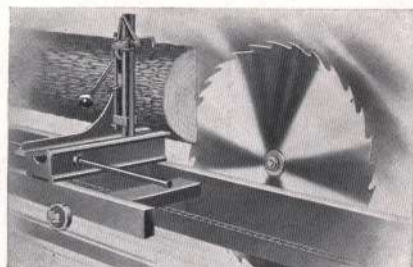

**Right Hand.**

See illustration of page 28, showing hand of shingle saws.

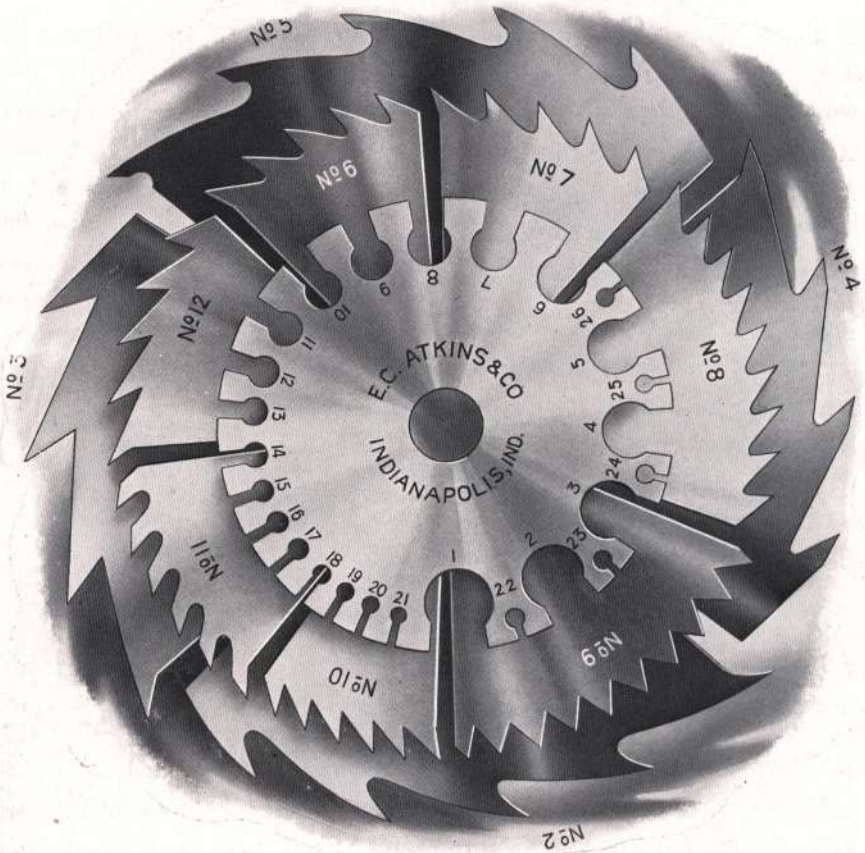

The above illustration represents our various styles and sizes of Saw Teeth; also our Standard Gauge. By consulting it a person will be enabled to inform us what size and style of tooth and also what thickness is desired.

**TABLE OF FRACTIONAL AND DECIMAL EQUIVALENTS TO ATHINS STANDARD GAUGE.**

Gauge.	Fractional Equivalent Inch.	Decimal Equivalent Inch.	Gauge.	Fractional Equivalent Inch.	Decimal Equivalent Inch.	Gauge.	Fractional Equivalent Inch.	Decimal Equivalent Inch.
1	$\frac{19}{64}$ full	.300	10	$\frac{9}{64}$ scant	.134	19	$\frac{3}{64}$ scant	.042
2	$\frac{9}{32}$ full	.284	11	$\frac{7}{8}$ scant	.120	20	.....	.035
3	$\frac{17}{64}$ scant	.259	12	$\frac{7}{16}$ scant	.109	21	$\frac{1}{32}$ full	.032
4	$\frac{15}{64}$ full	.238	13	$\frac{3}{32}$ full	.095	22	$\frac{1}{32}$ scant	.028
5	$\frac{7}{32}$ full	.220	14	$\frac{5}{64}$ full	.083	23	.....	.025
6	$\frac{13}{64}$ scant	.203	15	$\frac{5}{64}$ scant	.072	24	.....	.022
7	$\frac{11}{64}$ full	.180	16	$\frac{1}{16}$ full	.065	25	.....	.020
8	$\frac{11}{64}$ scant	.165	17	$\frac{1}{16}$ scant	.058	26	$\frac{1}{64}$ full	.018
9	$\frac{9}{64}$ full	.148	18	$\frac{3}{32}$ full	.049			

Above is Stubs Standard English Gauge, used by saw manufacturers of this country.



## THE SPEED OF CIRCULAR SAWS.

This is one of the most essential things to be observed, and no one can give it too much attention. If the speed of the saw is too high, it can not do good work, besides rendering it liable to many accidents. Too high a speed generates heat in the saw, makes it touchy and limber, so that it will only run and do good work on light feed, while the teeth are in the best of order, and have keen cutting points. As soon as the teeth are dull, the saw will run or dodge whenever it comes in contact with any unusual obstacle. Again, too low a speed has its objections, but it is not attended with such ruinous effects upon the saw. These difficulties can be remedied to a limited extent by the hammering of the saw, but cannot be entirely overcome. We keep in stock Speed Indicators, with which the speed of saw mandrel can be ascertained.

We have published a pamphlet entitled "Saws and Saw Tools," containing general information relative to the care and operation of saws, which will be mailed free to any address on application.

**TABLE OF SPEED OF CIRCULAR SAWS.**

Size of Saw. Inches.	Rev. per Minute. Speed.	Size of Saw. Inches.	Rev. per Minute. Speed.	Size of Saw. Inches.	Rev. Per Minute. Speed.	Size of Saw. Inches.	Rev. per Minute. Speed.
8.....	4,500	26.....	1,384	42.....	870	58.....	625
10.....	3,600	28.....	1,285	44.....	840	60.....	600
12.....	3,000	30.....	1,200	46.....	800	62.....	575
14.....	2,585	32.....	1,120	48.....	750	64.....	550
16.....	2,222	34.....	1,050	50.....	725	66.....	545
18.....	2,000	36.....	1,000	52.....	700	68.....	529
20.....	1,800	38.....	950	54.....	675	70.....	514
22.....	1,636	40.....	900	56.....	650	72.....	500
24.....	1,500						

### RULES FOR CALCULATING THE SPEED OF SAWS, PULLEYS OR DRUMS.

**PROBLEM 1.** The diameter of the driven being given, to find its number of revolutions.

**RULE**—Multiply the diameter of the driver by its number of revolutions, and divide the product by the diameter of the driven; the quotient will be the number of revolutions of the driven.

**PROBLEM 2.** The diameter and revolutions of the driver being given, to find the diameter of the driven, that shall make any given number of revolutions in the same time.

**RULE**—Multiply the diameter of the driver by its number of revolutions, and divide the product by the number of revolutions of the driven; the quotient will be its diameter.

**PROBLEM 3.** To ascertain the size of the driver.

**RULE**—Multiply the diameter of the driven by the number of revolutions you wish it to make, and divide the product by the revolutions of the driver; the quotient will be the size of the driver.

## ATKINS SOLID TOOTH CIRCULAR SAWS.

**PATENT GROUND AND TEMPERED.**

**Made from our celebrated Silver-Steel. Workmanship unequaled.**

Diameter, Inches.	Thickness, Gauge.	Size of Hole, Inches.	Price, Each.	Extra for Each Gauge Heavier.	Beveling New Saws, Per Gauge.	NET PRICES.	
						Rip.	Cross-Cut.
1	24	$\frac{3}{8}$	\$ 1 00	\$ 0 01	\$ 0 06	\$0 03	\$ 0 04
1½	24	$\frac{3}{8}$	1 00	01	07	03	05
2	23	$\frac{3}{8}$	1 00	01½	08	04	05
2½	22	$\frac{3}{8}$	1 00	02	09	04	06
3	21	$\frac{1}{2}$	1 00	02½	10	05	06
3½	20	$\frac{1}{2}$	1 00	03	12	05	07
4	19	$\frac{3}{4}$	1 20	03	14	06	07
5	19	$\frac{3}{4}$	1 50	04	16	06	08
6	18	$\frac{3}{4}$	1 80	05	18	07	10
7	18	$\frac{3}{4}$	2 10	06	20	08	11
8	18	$\frac{3}{4}$	2 40	08	22	10	13
9	17	$\frac{3}{8}$	2 80	10	25	11	14
10	16	1	3 30	12	28	12	16
11	16	1	3 90	16	30	13	18
12	15	1	4 40	20	35	15	20
14	14	$1\frac{1}{8}$	5 30	25	40	18	23
16	14	$1\frac{1}{8}$	6 50	30	50	20	25
8	13	$1\frac{1}{4}$	8 00	40	60	23	28
20	13	$1\frac{1}{4}$	9 50	50	70	25	32
22	12	$1\frac{1}{4}$	11 50	60	80	28	35
24	11	$1\frac{3}{8}$	13 50	70	90	31	40
26	11	$1\frac{3}{8}$	16 00	85	1 05	35	45
28	10	$1\frac{1}{2}$	18 50	1 00	1 20	38	50
30	10	$1\frac{1}{2}$	21 00	1 15	1 30	42	55
32	10	$1\frac{3}{8}$	24 00	1 30	1 40	45	60
34	9	$1\frac{3}{8}$	27 00	1 50	1 55	50	65
36	9	$1\frac{3}{8}$	31 00	1 80	1 70	55	70
38	9	$1\frac{3}{8}$	35 00	2 00	1 85	60	75
40	9	2	41 00	2 30	2 00	65	80
42	8	2	47 00	2 60	2 20		85
44	8	2	55 00	3 00	2 40		90
46	8	2	65 00	3 50	2 60		1 00
48	8	2	75 00	4 00	2 80		1 10
50	7	2	85 00	4 50	3 00		1 20
52	7	2	95 00	5 00	3 25		1 30
54	7	2	105 00	6 00	3 50		1 40
56	7	2	120 00	7 00	3 75		1 50
58	7	2	135 00	8 00	4 05		1 60
60	6	2	150 00	9 00	4 35		1 70
62	6	2	170 00	10 00	4 65		1 80
64	6	2	190 00	12 00	5 00		1 90
66	6	2	210 00	15 00	5 35		2 00
68	5	2	235 00	18 00	5 75		2 10
70	5	2	265 00	21 00	6 15		2 20
72	5	2	300 00	24 00	6 55		2 30
74	5	2	340 00	27 00	7 00		2 40
76	5	2	390 00	30 00	7 50		2 50
78	5	2	465 00	34 00	8 10		
80	5	2	550 00	38 00	8 80		
82	5	2	640 00	43 00	9 60		
84	5	2	730 00	48 00	10 50		

All Saws of odd diameter, not listed, take price of next larger size listed.

**BONE, HORN AND IVORY SAWS.** No extra charge to be made where these Saws are more than three gauges thinner than standard. No extra charge for fitting these Saws as it is understood that the 50 per cent advance includes fitting. When these Saws are hollow ground or beveled, the 50 per cent advance is to apply only on the list price of a straight gauge saw and not to apply to the extras for hollow grinding or beveling.

No extra charge for Saws one gauge thicker than list.

No extra charge for Saws one to three gauges thinner than list; when more than three gauges thinner, add 5 per cent to list for each gauge.

Circular Saws 48 inches and larger, thinner than 10 gauge are not warranted.

Circular Saws 42 inches or less in diameter beveled one gauge without extra charge; 44 inches or larger, beveled two gauges without extra charge.

Circular Saws hollow ground or concaved, add for each gauge hollow ground or concaved double the list for beveling.



## ATKINS TOP SAWS FOR DOUBLE MILLS. SILVER STEEL.

GAUGE.	DIAMETER IN INCHES.						
	24	26	28	30	32	34	36
10.....each	\$13 50	\$16 00	\$18 50	\$21 00	\$24 00	\$27 00	\$31 00

## RE-SAWING OR SIDING SAWS.

### GROUND TAPERING. SILVER-STEEL.

Diameter Inches.	Gauge.	Price, Each.	Diameter Inches.	Gauge.	Price, Each.
16	13x17	\$8 00	28	9x13	22 10
16	12x16	8 30	28	9x14	23 30
16	11x15	8 60	28	8x13	24 30
18	12x16	9 80	30	9x13	24 90
18	11x15	10 20	30	9x14	26 20
18	12x17	10 40	30	8x13	27 35
20	12x16	11 60	32	9x13	28 20
20	11x15	12 10	32	9x14	29 60
20	12x17	12 30	32	8x13	30 90
22	11x15	13 90	34	9x13	31 65
22	10x14	14 50	34	8x13	33 20
22	11x16	14 70	34	8x14	34 75
24	10x14	16 20	36	8x13	37 80
24	9x13	16 90	36	8x14	39 50
24	10x15	17 10	36	7x14	43 00
26	10x14	19 15	38	8x12	40 55
26	9x13	20 00	38	8x13	42 40
26	10x15	20 20	38	7x13	46 25

NOTE. List prices of all Re-saws are figured by using Solid Tooth Circular Saw list, adding extra gauges heavy, and gauges beveling, allowing one gauge heavier than standard and one gauge beveling on Saws 42 inches and less in diameter, and two gauges on Saws 44 inches and over, without extra charge.

## SILVER-STEEL EDGER SAWS.

### SOLID TOOTH.

Diameter Inches.	PRICE.				
	Gauge 8.	Gauge 9.	Gauge 10.	Gauge 11.	Gauge 12.
12	\$5 60	\$5 40	\$5 20	\$5 00	\$4 80
14	6 55	6 30	6 05	5 80	5 55
16	8 00	7 70	7 40	7 10	6 80
18	9 60	9 20	8 80	8 40	8 00
20	11 50	11 00	10 50	10 00	9 50
22	13 30	12 70	12 10	11 50	11 50
24	14 90	14 20	13 50	13 50	13 50

## ATKINS CONCAVE SAWS. SILVER-STEEL.

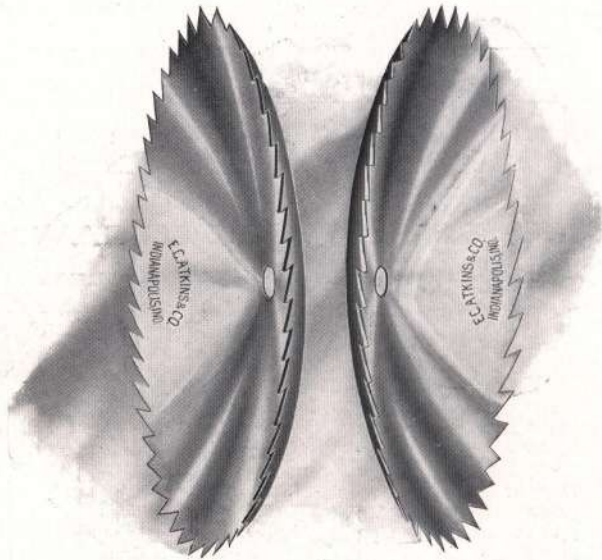

**Left Hand.**

**Right Hand.**

The attention of manufacturers of chair or wheelwright lumber, barrels, etc., is respectfully called to Concave Saws, of which we are manufacturing large quantities. They are dished and tempered by an entirely new and patented process, and guaranteed to be of superior quality in every respect.

Inches.	Gauge.	Price, Each.	For Each Additional Gauge, Extra.
4	16	\$2 30	\$0 05
5	16	2 40	05
6	16	2 50	05
7	15	2 90	06
8	15	3 30	08
9	15	3 80	10
10	14	4 60	12
11	14	5 40	16
12	14	6 20	20
14	13	7 60	25
16	13	9 50	30
18	12	11 30	40
20	12	14 20	50

Saws concaved to a smaller circle than 16 inches, extra price.

### Extra Sizes Made to Order.

When ordering Concave Saws, give circle to be dished to; also, which side is to be dished or concaved, right or left hand, as the saw runs toward you. (See cut.)



**ATKINS SHINGLE AND HEADING SAWS.**

**Gas Tempered. For All Makes of Machines.**



**SILVER-STEEL.**

**TAPERED AND PATENT GROUND.**

**When Ordering Shingle Saws, Give Following Specifications:**

Diameter of saw (in inches). Thickness or gauge at center. Thickness or gauge at rim. Number of teeth. Right or left hand. Speed.

If you wish us to furnish the flange, give maker's name of machine, or send full and correct templet of old flange, giving size and location of holes.

If you have flange and we are to furnish the saw only, send it to us that we may fit it to the saw, or if you can not send it, send templet of holes and sample of screw by which to drill and countersink saw.

## ATKINS SHINGLE AND HEADING SAWS.

**SILVER-STEEL, PATENT TAPER GROUND.**

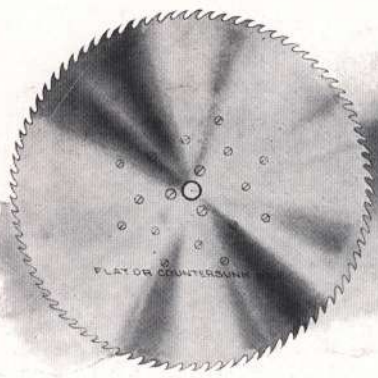

**Left Hand.**

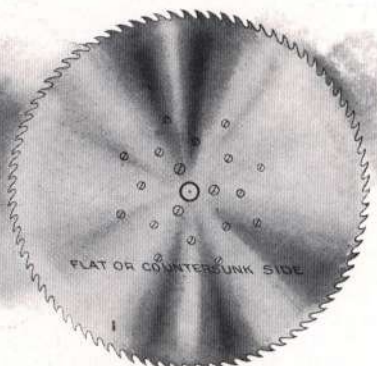

**Right Hand.**

Diameter, Inches.	Price, Each.	Diameter, Inches.	Price, Each.
30	\$32 00	46	\$85 00
32	35 00	48	100 00
34	38 00	50	115 00
36	42 00	52	135 00
38	47 00	54	155 00
40	53 00	56	175 00
42	65 00	58	195 00
44	72 00	60	215 00

Above list is for Saws beveled not more than 8 gauges, and with thickness at center of same gauge as shown in Solid Tooth Circular Saw list for Saws of same diameter, but one gauge thicker is allowed without extra charge.

For any additional thickness or beveling, add for each gauge thicker or gauge beveling as per Solid Tooth Circular Saw list.

WHEN ORDERING SHINGLE OR HEADING SAWS give the following specifications: Diameter of Saw in inches. Thickness or gauge at center and at rim. Number of teeth. Right or left hand. Speed of Saw. Name of maker of machine and size of flange.

If new flange is required, send full size template of old flange, showing size and location of all holes.

If Saw only is required, send the old flange to us to be fitted to the Saw, or if this cannot be done, send template of holes and a sample screw by which to drill and countersink Saw.

Special prices on Flanges for Trevor, Challoner and Perkins Machines quoted on application.

### COLLARS FOR SHINGLE, HEADING OR RE-SAWS.

New cast iron flanges for standard makes of Shingle Machines fitted to new Saws, \$1.50 per inch in diameter.

New steel flanges, 8 inches to 26 inches in diameter,  $\frac{3}{8}$  inch thick or less, fitted to new Saws, either with screws or rivets, \$1.00 per inch.

Flanges other than above, special price.

Fitting old flanges to new Saws, \$2.00 each, net.



## ATKINS SILVER-STEEL SEGMENT VENEER SAWS.

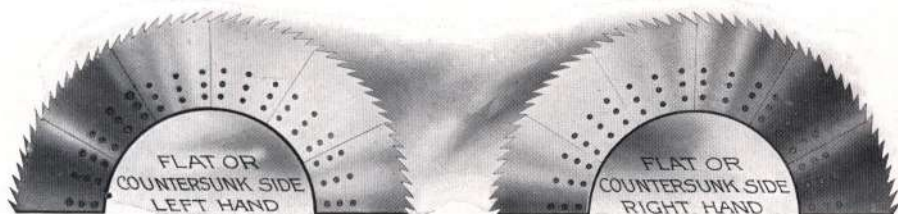

When ordering Segments give gauge or thickness at butt, gauge or thickness at edge, depth of bevel, diameter of saw that segments are to form, number of segments in saw, depth of segments, number of teeth in each segment, sample of screw by which to drill and countersink flat or countersunk side, and direction in which teeth run. (See engraving.)

In ordering for a flange that has been drilled, send a sheet iron or tin templet, or a correct tracing showing holes and other particulars, or one of the old segments giving the depth they originally were.

### Price Per Foot in Diameter of Saw.

Veneer Saws, 19 gauge and thinner.		Re-Saws, 18 gauge and thicker.
12 inches deep, 5 gauge.....	\$22 40	\$18 95
12 " " 6 ".....	21 40	18 10
12 " " 7 ".....	20 40	17 25
12 " " 8 ".....	19 10	16 15
12 " " 9 ".....	18 45	15 60
12 " " 10 ".....	17 80	15 00

Add 5 per cent. for each additional inch in depth.  
Deduct 5 per cent. for each inch under 12 inches in depth.

### Rates for repairing Segment Saws.

Per foot in diameter.		Per foot in diameter.	
Grinding first and second gauge.....	\$2 50	Gumming.....	\$0 80
Grinding each additional gauge.....	56	Re-toothing and Hammering.....	2 20
Hammering.....	95		

## COLLARS FOR SEGMENT VENEER AND RE-SAWS.

### Net Price for Segment Re-Saw Collar Complete.

Consisting of cast iron flange and steel rim collar fitted to segments; including screws and coppers.

Diam. Collars, Inches.	Net Prices Fitted.	Diam. Collars, Inches.	Net Prices Fitted.	Diam. Collars, Inches.	Net Prices Fitted.	Diam. Collars, Inches.	Net Prices Fitted.
14	\$17 50	20	\$25 00	26	\$36 00	32	\$52 00
16	20 00	22	28 00	28	40 00	34	60 00
18	22 50	24	32 00	30	45 00		

### Net Prices for Fitting Segments to Old Collars.

Including screws and coppers.

Diam. Collars, Inches.	Net Prices.	Diam. Collars, Inches.	Net Prices.	Diam. Collars, Inches.	Net Prices.	Diam. Collars, Inches.	Net Prices.
14	\$5 00	20	\$8 00	26	\$11 00	32	\$14 00
16	6 00	22	9 00	28	12 00	34	15 00
18	7 00	24	10 00	30	13 00		

Veneer Saw Flanges two-thirds of above prices.

When new collars of any special style different from our standard patterns are required, we charge for the pattern at actual cost; this will average from \$1.50 to \$2.50, according to the size.

Extra coppers 75 cents per dozen. Extra screws 20 cents per dozen.

**ATKINS CIRCULAR MITRE SAWS.**  
SILVER-STEEL-HOLLOW GROUND.

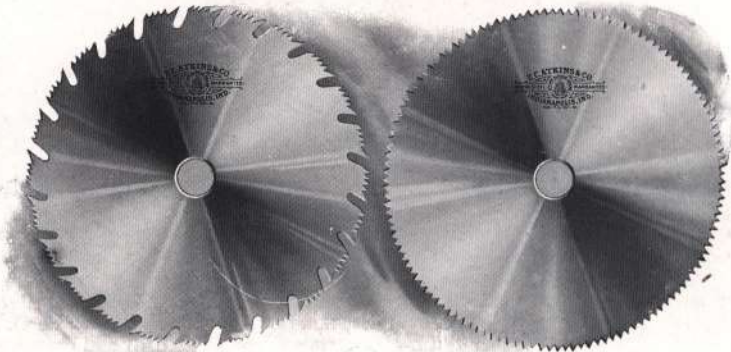

**Mitre Saw With Cleaner Teeth.**

**Mitre Saw.**

These saws are ground to run without set; especially adapted for smooth cutting, such as cabinet and cigar-box work. Give size of center hole, also diameter of collars or mandrel.

Size, Inches	Gauge at Holes.	Gauge at Edge of Collar	Gauge at Teeth.	Extra for Each Gauge Heavier.	Extra for Each Additional Gauge Beveling.	Price, Each.	Size, Inches	Gauge at Holes.	Gauge at Edge of Collar	Gauge at Teeth.	Extra for Each Gauge Heavier	Extra for Each Additional Gauge Beveling.	Price, Each.
4	18	21	18	\$0 03	\$0 14	\$3 00	12	14	17	14	\$0 20	\$0 35	\$3 30
5	17	20	17	04	16	3 60	14	13	16	13	25	40	9 80
6	17	20	17	05	18	4 20	16	13	16	13	30	50	11 60
7	16	19	16	06	20	4 80	18	12	15	12	40	60	13 70
8	16	19	16	08	22	5 40	20	12	15	12	50	70	16 20
9	15	18	15	10	25	6 00	22	11	14	11	60	80	19 00
10	15	18	15	12	28	6 70	24	11	14	11	70	90	22 00
11	14	17	14	16	30	7 50							

Above list includes filing teeth so that saw is ready for use.

**CIRCULAR MITRE SAW WITH CLEANER TOOTH.**

This saw can be made for either ripping or cross-cutting. When used for ripping we put in a greater number of cleaner teeth than when used for cross-cutting. It will cut equally as smooth in either ripping or cross-cutting. USE MITRE SAW LIST AS ABOVE.

**GROOVING SAWS.**

Diameter Inches	THICKNESS.								
	1/8 in.	3/16 in.	1/4 in.	5/16 in.	3/8 in.	7/16 in.	1/2 in.	5/8 in.	3/4 in.
3	\$1 60	\$2 20	\$4 00	\$4 60	\$5 20	\$5 80	\$6 40	\$7 50	\$8 50
4	1 80	2 50	4 80	5 50	6 20	6 80	7 60	8 80	10 00
5	2 00	2 80	5 60	6 40	7 20	8 00	8 80	10 20	12 00
6	2 30	3 20	6 40	7 30	8 20	9 10	10 00	11 60	14 00
7	2 70	3 70	7 20	8 20	9 20	10 20	11 20	13 20	16 00
8	3 20	4 30	8 00	9 20	10 40	11 60	12 70	15 00	18 00
9	3 80	5 00	9 00	10 30	11 60	12 90	14 30	16 80	20 00
10	4 40	5 80	10 00	11 40	12 90	14 40	15 90	18 80	22 00
11	5 00	6 70	11 00	12 60	14 20	15 90	17 60	20 80	24 00
12	5 70	7 70	12 00	13 80	15 60	17 40	19 20	23 00	26 00
14	7 00	9 80	14 00	16 00	18 00	20 00	22 00	26 00	30 00
16	8 40	12 00	16 00	18 30	20 60	22 90	25 20	30 00	35 00
Space Teeth.	1/2 in.	1 in.	1 in.	1 1/4 in.	1 1/2 in.	1 3/4 in.	2 in.	2 in.	2 in.



Bevel Grooving Saws, add 10 per cent to above prices. Grooving Saws with teeth shaped and backed off, add 50 per cent to above prices. Special Grooving Saws made to order, special prices.



**THE McLEAN & McKAM PATENT  
CIRCULAR SAW.**

**SILVER-STEEL.  
UNEQUALLED FOR SMOOTH SAWING.**



The demand for a saw that would cut a sufficiently smooth joint or edge to avoid the necessity of planing has been satisfactorily met in the new McLean & McKam Patent Tooth Circular Saw. It does equally good work in cross-cutting, ripping or mitreing.

This style of saw is very desirable for use in planing mills, furniture, moulding and picture frame factories and pattern shops, as the character of the work done by it is so smooth that a glue joint can be made direct from the saw. A trial is convincing proof.

**INSTRUCTIONS FOR ORDERING.**

Saws to be used exclusively for ripping or for cross-cutting should be so specified. If saws are to be used as general purpose saws both for ripping and cross-cutting, specify in ordering. For smooth work, order hollow ground saws, and specify size of collars. Saws 12 inches to 18 inches will be made hollow ground unless otherwise ordered. Saws 20 inches and over will be made straight ground and set unless otherwise ordered.

In filing these saws, file only the top of the tooth, and be careful to file the same clearance as in the saw when new. Hollow ground saws of this type are designed to run without set. Straight ground saws require much less set than ordinary saws; the set should be sprung in the tooth at least half way down the tooth, and care should be used in setting not to twist the tooth out of the plane of the saw plate.

Size, Inches.	Gauge.	No. Teeth.	Extra for Each Gauge Heavier than List.	Extra for Additional Gauge Beveling.	List Hollow Ground.	List Set Tooth.
12	12 x 15	48	\$0 25	\$0 35	\$6 00	\$ 5 05
14	12 x 15	58	32	40	7 25	6 30
16	12 x 15	64	38	50	8 50	7 80
18	11 x 14	76	45	60	10 00	9 80
20	10 x 14	84	53	70	12 50	11 85
22	10 x 14	92	68	80	15 00	14 45
24	10 x 14	100	83	90	18 00	17 00
26	9 x 12	108	1 00	1 05	21 00	19 60
28	9 x 12	116	1 25	1 20	24 50	22 20
30	9 x 12	116	1 50	1 30	28 00	24 75
32	8 x 11	124	1 75	1 40	31 50	28 40
34	7 x 10	130	2 00	1 55	35 50	32 15
36	7 x 10	140	2 25	1 70	39 50	35 80
38	7 x 10	150	2 50	1 85	43 00	39 50
40	7 x 10	146	2 75	2 00	50 00	45 40
42	7 x 10	150	3 00	2 20	57 50	52 45
44	7 x 10	160	3 25	2 40	67 50	61 70
46	7 x 10	160	3 50	2 60	81 00	73 15
48	6 x 9	182	4 50	2 80	100 00	84 60
50	6 x 9	172	5 00	3 00	108 00	96 10

## ATKINS SILVER-STEEL WABBLE SAWS.

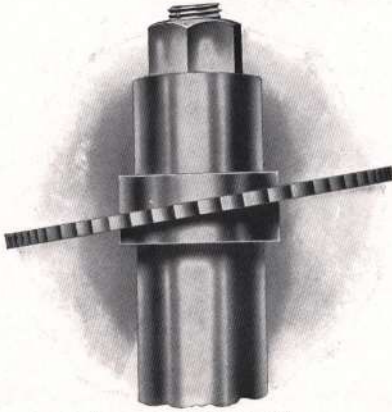

**Prices, With Collars.**  
 $\frac{1}{4}$ -inch Thick.

5 inches .....	\$15 00
6 inches .....	16 00
7 inches .....	17 00
8 inches .....	18 00
9 inches .....	19 00
10 inches .....	20 00



**Prices, Saws Only.**  
 $\frac{1}{4}$ -inch Thick.

5 inches .....	\$6 30
6 inches .....	7 20
7 inches .....	8 40
8 inches .....	9 60
9 inches .....	10 80
10 inches .....	12 00

Special Saws at Special Prices. In ordering be sure to send Old Collars.

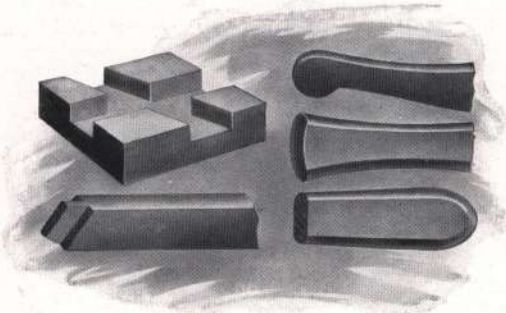

The accompanying illustrations are a few samples of the great range of work that can be done with the Wabble Saw.

## SPECIAL HEADING CUTTERS.

### SOLID OR INSERTED TEETH.

We make a feature of Special Heading Cutters used in connection with Concave Saws. Made of High-Grade Silver-Steel according to individual specifications. Write us for further information and quotations.

Be sure to give the following information:

Thickness, Size Hole, Diameter of Convex Side, Diameter of Concave Side, Radius of Circle, Diameter of Countersunk Head, Depth of Countersunk Head, Turn to Right or Left, Tempered Low for Filing, Tempered Medium for Filing, Tempered High for Grinding.

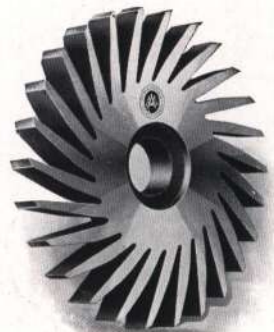



## ATKINS CIRCULAR SAWS FOR CUTTING METAL AT SLOW SPEED.



Diam., Inches.	Thick., Inches.	Size of Hole, Inches.	List Price.	Diam., Inches.	Thick., Inches.	Size of Hole, Inches.	List Price.
2 1/2	1 3/8	7/8	\$1 15	4	5 3/8	1	\$1 85
2 1/2	1 3/8	7/8	1 20	4	3 3/8	1	1 90
2 1/2	1 3/8	7/8	1 25	5	1 1/8	1	1 90
2 1/2	1 3/8	7/8	1 35	5	1 1/8	1	2 05
2 1/2	1 3/8	7/8	1 40	5	3/8	1	2 15
2 1/2	1 3/8	7/8	1 50	5	1/8	1 1/4	2 15
3	1 3/8	1	1 30	5	1/8	1 1/2	2 15
3	1 3/8	1	1 35	5	3/8	1	2 30
3	1 3/8	1	1 40	5	1 3/8	1	2 40
3	1 3/8	1	1 50	6	1 1/8	1	2 35
3	1 3/8	1	1 55	6	1 1/8	1	2 54
3	1 3/8	1	1 65	6	1 1/8	1	2 65
4	1 3/8	1	1 50	6	3/8	1 1/2	2 95
4	1 3/8	1	1 55	6	1 1/8	1	2 95
4	1 3/8	1	1 60	7	1 1/8	1	3 00
4	1 3/8	1	1 70	7	3/8	1	3 25
4	1 3/8	1	1 75	7	1 1/8	1	3 40

## CIRCULAR MILLING SAWS.

Diam., In.	Thickness.		Size of Hole, Inches.	Price, Each.	Extra for each Additional Gauge Heavier.	Diam., In.	Thickness.		Size of Hole, Inches.	Price, Each.	Extra for each Additional Gauge Heavier.
	Inch.	Gauge.					Inch.	Gauge.			
8	1 1/8	16	1	\$ 4 00	\$0 12	31	1/4	3	2 1/2	\$ 55 00	\$ 2 00
9	5 3/4	14	1	5 00	15	36	1/4	3	2 1/2	62 50	3 00
10	5 3/4	14	1 1/4	6 50	20	38	3/8	2	2 1/2	78 00	4 00
12	3 3/8	13	1 1/4	8 00	25	40	3/8	2	2 1/2	95 00	5 50
14	1/8	11	1 1/2	9 50	35	42	5 1/8	0	3	105 00	7 00
16	5 3/8	9	1 1/2	11 75	40	44	1 1/8	0	3	115 00	9 00
18	5 3/8	8	1 3/4	14 75	50	46	5 1/8	0	3	125 00	11 00
20	5 3/8	8	1 3/4	17 50	60	48	5 1/8	0	3	140 00	13 00
22	3 1/8	7	2	20 50	70	50	3 3/8	00	3	160 00	15 50
24	3 1/8	7	2	23 50	80	52	3 3/8	00	3	180 00	18 00
26	3 1/8	7	2 1/2	28 00	1 00	54	3 3/8	00	3	200 00	20 00
28	7 3/8	5	2 1/2	35 00	1 25	56	3 3/8	00	3	220 00	22 00
30	7 3/8	5	2 1/2	40 00	1 40	58	7 1/8	000	3	250 00	25 00
32	7 3/8	3	2 1/2	48 00	1 75	60	7 1/8	000	3	275 00	28 00

### PITCH OF TEETH.

8, 9 in., 4, 5, 6, 7 teeth per in.; 10 in., 3, 4, 5, 6 teeth per in.; 12 in., 1/8, 3/8, 1/4, 5/8 in., 14 in., 1/4, 5/8, 3/8 in.; 16, 28, 20 in., 5/8, 3/8, 7/8 in., 22 in., 3/8, 7/8, 9/8 in.; 24 to 32 in., 3/8, 7/8, 1 1/8, 5/8 in.; 34 to 36 in., 1/8, 1/2, 3/4 in.; 38 to 48 in., 1/8, 1/2, 3/4, 7/8 in.; 50 to 60 in., 3/8, 1/2, 3/4, 1 in.

Milling saws made over at two-thirds price of new saws. Special sizes made to order. The above list covers cost of saws ground thin towards the center for clearance. Saws of this pattern also furnished same thickness at center and rim, and teeth set to obtain clearance in cut.

Specify on your order diameter and thickness, also size of arbor hole, size and position of pin holes, pitch of teeth and diameter of mandrel collars. We manufacture saws for all makes of machines.

## ATKINS CIRCULAR SAWS FOR CUTTING HOT OR COLD IRON AT HIGH SPEED.



Diameter, Inches.	Gauge.	List Price.	Diameter, Inches.	Gauge.	List Price.	Diameter, Inches.	Gauge.	List Price.
14	10	\$ 4 00	28	6	\$13 50	40	3	\$29 50
16	10	5 00	30	6	15 50	42	3	35 00
18	8	6 50	32	6	17 00	44	3	41 00
20	8	7 50	34	5	18 50	46	3	50 00
22	7	9 00	36	5	20 50	48	3	60 00
24	7	10 50	38	4	24 00	50	3	70 00
26	7	12 00						

## CIRCULAR DISCS (WITHOUT TEETH) FOR CUTTING HOT OR COLD IRON AT HIGH SPEED.

Diameter, Inches.	Gauge.	List Price.	Diameter, Inches.	Gauge.	List Price.
14	10	\$ 3 75	34	5	\$18 50
16	10	4 25	36	5	20 50
18	8	5 50	38	4	24 00
20	8	7 00	40	3	28 00
22	7	8 25	42	3	32 00
24	7	10 25	44	3	36 00
26	7	11 50	46	3	45 00
28	6	13 00	48	3	50 00
30	6	15 00	50	3	60 00
32	6	16 00			



## ATKINS SPECIAL MILLING SAWS FOR BRYANT MACHINE.



Diam., Inches.	Gauge.	Size Hole.	No. Teeth.	Price, Each.
16	9 x 7	3/8	31	\$12 55
20 1/2	6 x 3	1 1/4	38	23 30
25	6 x 3	1 3/4	46	32 00
30	5 x 2	1 3/4	40	44 20
36	5 x 2	2	67	65 50

## SPECIAL MILLING SAWS FOR HIGLEY MACHINE.

Diameter, Inches.	Thickness, Inches.	Size of Hole, Inches.	New Style of Machine.	Old Style of Machine.	Price, Each.
12 1/2	1/2	1 1/4	10	Bench	\$ 9 50
13 1/2	3/4	1 1/4	11	.....	9 50
13 1/2	3/4	1 1/4	.....	5	10 55
13 1/2	3/4	1 1/4	11	.....	10 90
15	3/4	1 1/4	12	.....	12 15
16	3/4	1 1/4	13	3	12 55
17 1/2	3/4	1 1/4	30	.....	15 25
18	3/4	1 1/4	14	2	14 75
18	3/4	1 1/4	14	2	15 25
18	3/4	1 1/4	14	2	16 25
18 1/2	3/4	1 1/4	14	2	19 30
20	3/4	1 1/4	15	8	18 10
20	3/4	1 1/4	16	20" Cambria	18 10
20	3/4	1 1/4	16	20" Cambria	19 30
20	3/4	1 1/4	31	.....	18 10
26	3/4	1 1/4	17	26" Cambria	28 00
26	3/4	1 1/2	19	1	28 00
26	3/4	1 1/2	19	1	32 00
28	3/4	1 1/2	.....	1	35 00
30	3/4	1 1/2	.....	1	40 00
31	3/4	1 1/2	18	7	48 00
31	3/4	1 1/2	20	1 1/2	48 00
31	3/4	1 1/2	21	9	48 00
36	3/4	1 1/2	21 1/2	.....	65 50
36	3/4	1 1/2	21 1/2	.....	71 50
40	3/4	1 1/2	22	.....	105 50
40	3/4	1 1/2	22	.....	111 50
50	3/4	1 1/2	24	.....	206 50

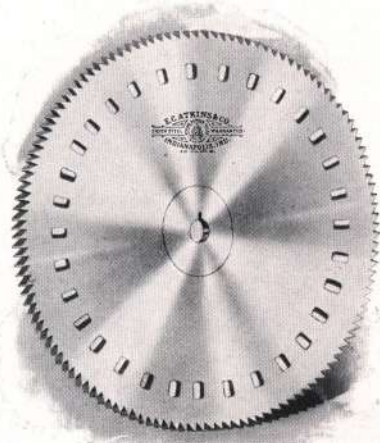

## LATHE SAWS.

Diam., Inches.	Gauge.	Price.	Extra for Each Additional Gauge. (Heavier.)	Diam., Inches.	Gauge.	Price.	Extra for Each Additional Gauge (Heavier.)
6	9	\$2 00	\$0 12	13	5	\$4 25	.....
7	9	2 25	12	13	6	4 00	.....
8	9	2 50	15	14	2	5 50	.....
9	8	2 75	15	14	3	5 25	.....
10	7	3 00	20	14	4	5 00	.....
11	7	3 30	20	14	5	4 75	.....
12	6	3 60	20	14	6	4 50	.....
13	2	5 00	.....	15	5	5 00	\$0 30
13	3	4 75	.....	15	5	5 00	30
13	4	4 50	.....	16	5	5 60	.....

## HOLLOW GROUND CIRCULAR METAL SAWS MADE OF HIGH SPEED STEEL.

Diameter, Inch.	Face, Inch.	Hole, Inch.	Price.
2½	$\frac{1}{16}$	$\frac{7}{8}$	\$3 80
2½	$\frac{3}{32}$	$\frac{7}{8}$	3 80
2½	$\frac{1}{8}$	$\frac{7}{8}$	3 80
2½	$\frac{5}{32}$	$\frac{7}{8}$	4 85
3	$\frac{1}{16}$	1	4 05
3	$\frac{3}{32}$	1	4 05
3	$\frac{1}{8}$	1	4 05
3	$\frac{5}{32}$	1	5 00
4	$\frac{1}{16}$	1	5 15
4	$\frac{3}{32}$	1	5 15
4	$\frac{1}{8}$	1	5 15
4	$\frac{5}{32}$	1	5 65
5	$\frac{1}{16}$	1	6 25
5	$\frac{3}{32}$	1	5 65
5	$\frac{1}{8}$	1	6 25
5	$\frac{1}{8}$	$1\frac{1}{4}$	6 25
5	$\frac{1}{8}$	$1\frac{1}{2}$	6 25
5	$\frac{5}{32}$	1	7 60
5	$\frac{3}{16}$	1	7 60
5	$\frac{3}{16}$	$1\frac{1}{2}$	7 60
6	$\frac{1}{8}$	1	8 70
6	$\frac{3}{16}$	1	10 85
7	$\frac{1}{8}$	1	11 65
7	$\frac{3}{16}$	1	15 75
8	$\frac{1}{8}$	1	18 50
9	$\frac{1}{8}$	1	21 80
10	$\frac{1}{8}$	$1\frac{1}{4}$	28 40
12	$\frac{1}{8}$	$1\frac{1}{4}$	34 00
14	$\frac{5}{32}$	$1\frac{1}{2}$	42 00
16	$\frac{3}{16}$	$1\frac{1}{2}$	50 20
18	$\frac{3}{16}$	$1\frac{3}{4}$	61 00



## ATKINS CIRCULAR KNIVES.

**FOR CUTTING CORK, LEATHER, PAPER, CLOTH, Etc.**

In ordering please give the following specifications:

- |                  |                                  |
|------------------|----------------------------------|
| 1. Diameter.     | 4. Width of Bevel.               |
| 2. Gauge.        | 5. Beveled on one or both sides. |
| 3. Size of Hole. |                                  |

NOTE—We allow two gauges heavier than listed without extra charge. Add 5 per cent. for each additional gauge.

This list is for knives made of regular quality steel with a bevel not over 1 inch in length.

We make special cutters for all purposes. Prices quoted on application.



### Price List.

Diameter....	4	5	6	7	8	9	10	12	14
Gauge ....	14	14	14	14	14	14	14	12	11
List Price ...	\$1 40	\$1 75	\$2 10	\$2 45	\$2 80	\$3 15	\$3 50	\$4 80	\$6 30
Diameter....	16	18	20	22	24	26	28	30	32
Gauge .....	10	9	9	8	8	7	7	6	6
List Price ...	\$8 00	\$9 90	\$12 00	\$14 30	\$16 80	\$19 50	\$22 40	\$25 50	\$30 40

## LOCK CORNER BOX CUTTERS.

Prices quoted on application.



## CIRCULAR SAWS FOR SLATE.

Diameter, Inches.	Gauge.	Price, Each.	Extra for Each Gauge Heavier.	Diameter, Inches.	Gauge.	Price, Each.	Extra for Each Gauge Heavier.
14	10	\$4 25	\$0 14	30	5	\$16 00	\$0 60
16	10	5 25	17	32	5	17 75	67
18	9	6 75	20	34	5	19 50	80
20	8	7 75	23	36	4	22 50	93
22	7	9 50	30	38	4	25 50	1 17
24	6	11 00	37	38	3/8"	30 00	1 33
26	6	12 50	43	40	4	30 00	1 33
28	5	14 25	53				

No extra charge for saws one gauge heavier than above list.

— ATKINS SILVER STEEL SAWS —

**A T K I N S**  
**C E L E B R A T E D**

---

---

**SILVER-STEEL**

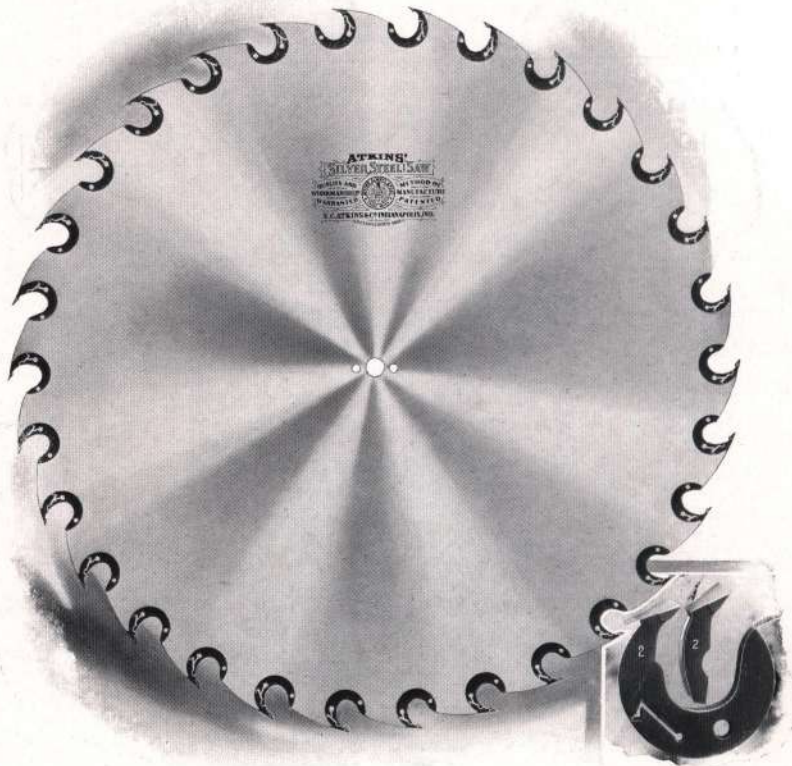

---

---

**INSERTED TOOTH**  
**CIRCULAR SAWS**



**Atkins Chisel Bit Saws**  
**SILVER-STEEL GAS TEMPERED.**

The same kind of steel is used in our Chisel Bit plates as in our Solid Tooth Circular Saws. The Saws are tempered in the same manner and as carefully tested to guard against flaws or defects of any kind. This is a feature that, we believe, is exclusive with us and enables our Saws to receive a more accurate degree of tension and to retain it longer than any other Chisel Bit Saws on the market.

The bits are made from a SPECIALLY SELECTED STEEL manufactured expressly for our use and containing in the highest degree the qualities required in a saw tooth, namely: An exceedingly HARD but TOUGH, temper, capable of holding a cutting point for a long time, thus producing the largest possible output of lumber per set. In this respect the Atkins bits have a remarkable record.

The SHAPE of the bit is another point of superiority. Particular attention has been given to the best form of forging and grinding to give the greatest amount of wear with the best clearance and yet preserve the swage until the bit is worn out.

The HOLDERS are made from another kind of steel, also selected for the specific work required, namely: A strong spring, not easily broken, and yet hard enough to stand the wear. They are also shaped to give the maximum amount of wear, and keep the dust from crowding between the blade and the timber.

Our styles of teeth and holders are adapted to the needs of all sections. While we illustrate those which we deem the best and most in demand, we manufacture several other patterns, including those most largely used besides the styles shown.

N. B.—We manufacture, or will procure, extra teeth for all makes of saws. In ordering give number (indicating style) and gauge; or send sample. Send for circular showing styles of teeth manufactured by us. Solid Tooth Saws and Inserted Tooth Saws of any kind made over into our IMPROVED PATTERNS at reasonable prices.

## ATKINS INSERTED TOOTH SAWS. CHISEL TOOTH No. 2.

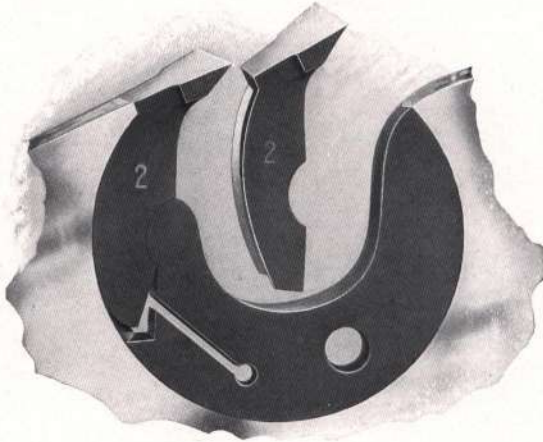

**This cut shows full size of No. 2 Tooth.**

Diameter, Inches.	Gauge.	Standard Number of Teeth.	Size Hole, Inches.	List Price.	Extra for Each Additional Gauge Heavier.	List for Beveling New Saws Per Gauge.	Number Teeth Furnished With Each Saw.
12	11	10	1	\$19 00	\$0 20	\$0 35	100
14	11	12	1 1/8	22 00	25	40	100
16	11	14	1 1/8	25 50	30	50	100
18	11	16	1 1/4	28 50	40	60	100
20	11	18	1 1/4	32 00	50	70	100
22	11	20	1 1/2	36 50	60	80	100
24	11	22	1 3/8	40 00	70	90	100
26	10	24	1 3/8	44 00	85	1 05	100
28	10	24	1 1/2	48 00	1 00	1 20	100
30	10	24	1 1/2	52 00	1 15	1 30	100
32	9	26	1 3/8	58 00	1 30	1 40	200
34	9	26	1 3/8	63 00	1 50	1 55	200
36	8	28	1 3/8	69 00	1 80	1 70	200
38	8	28	1 3/8	74 00	2 00	1 85	200
40	8	30	2	80 00	2 30	2 00	200
42	8	32	2	89 00	2 60	2 20	200
44	7	36	2	96 00	3 00	2 40	200
46	7	36	2	104 00	3 50	2 60	200
48	7	40	2	113 00	4 00	2 80	200
50	7	40	2	127 00	4 50	3 00	200
52	6	44	2	148 00	5 00	3 25	200
54	6	44	2	165 00	6 00	3 50	300
56	6	48	2	180 00	7 00	3 75	300
58	6	48	2	200 00	8 00	4 05	300
60	5	52	2	220 00	9 00	4 35	300
62	5	52	2	245 00	10 00	4 65	300
64	5	56	2	275 00	12 00	5 00	300
66	5	56	2	300 00	15 00	5 35	300
68	5	60	2	325 00	18 00	5 75	300
70	4	60	2	355 00	21 00	6 15	3.0
72	4	60	2	390 00	24 00	6 55	300

Two extra holders furnished with Saws 40 inches diameter and less. Three extra holders with Saws 42 inches diameter and over.

Duplicate teeth for No. 2 Saws \$4.80 per hundred. Duplicate holders for No. 2 Saws, 40 cents each. Wrenches, \$1.00 each.

For changing Solid Tooth Saws into Inserted Tooth Saws, \$1.50 per Tooth, plus one-half list price of Solid Tooth Saw of same size. This price is based upon size Saw will finish after cutting down, and is subject to same discount as Inserted Tooth Saws.



## ATKINS INSERTED TOOTH SAWS. CHISEL TOOTH No. 2½.

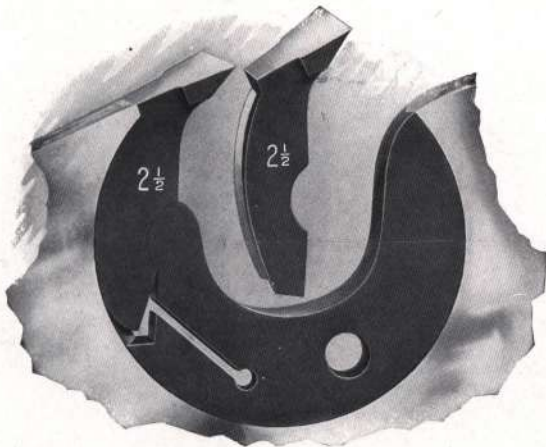

**This Cut shows full size of No. 2½ Tooth, specially adapted for High Speed and Heavy Feed.**

Diameter, Inches.	Gauge.	Standard Number of Teeth	Size Hole, Inches.	List Price.	Extra for Each Additional Gauge Heavier.	List for Beveling New Saws Per Gauge.	Number Teeth Furnished With Each Saw.
12	11	12	1 1/8	\$20 00	\$0 20	\$0 35	109
14	11	14	1 1/8	23 00	25	40	100
16	11	16	1 1/8	26 00	30	50	100
18	11	18	1 1/8	30 00	40	60	100
20	11	20	1 1/8	34 00	50	70	100
22	11	22	1 1/8	38 00	60	80	200
24	11	24	1 1/8	43 00	70	90	200
26	10	26	1 3/8	49 00	85	1 05	200
28	10	28	1 1/2	55 00	1 00	1 20	200
30	10	30	1 1/2	60 00	1 15	1 30	200
32	9	32	1 3/8	68 00	1 30	1 40	300
34	9	36	1 3/8	76 00	1 50	1 55	300
36	8	38	1 3/8	82 00	1 80	1 70	300
38	8	40	1 3/8	90 00	2 00	1 85	300
40	8	42	2	98 00	2 30	2 00	300
42	8	44	2	106 00	2 60	2 20	400
44	7	46	2	114 00	3 00	2 40	400
46	7	48	2	124 00	3 50	2 60	400
48	7	50	2	135 00	4 00	2 80	400
50	7	52	2	146 00	4 50	3 00	400
52	6	56	2	162 00	5 00	3 25	500
54	6	58	2	180 00	6 00	3 50	500
56	6	60	2	205 00	7 00	3 75	500
58	6	62	2	225 00	8 00	4 05	500
60	5	64	2	250 00	9 00	4 35	500
62	5	66	2	275 00	10 00	4 65	500
64	5	68	2	300 00	12 00	5 00	500
66	5	72	2	325 00	15 00	5 35	500
68	5	76	2	365 00	18 00	5 75	500
70	4	78	2	410 00	21 00	6 15	500
72	4	80	2	450 00	24 00	6 55	500

Two extra holders furnished with Saws 40 inches diameter and less. Three extra holders furnished with Saws 42 inches diameter and over.

Duplicate teeth for No. 2½ Saws \$4.80 per 100. Duplicate holders for No. 2½ Saws \$0.40 each. Wrenches \$1 each. For changing Solid Tooth Saws into Inserted Tooth Saws \$1.50 per tooth plus one-half list price of solid tooth saw of same size. This price is based upon size Saw will finish after cutting down and is subject to same discount as Inserted Tooth Saws.

## ATKINS INSERTED TOOTH SAWS. CHISEL TOOTH No. 3.

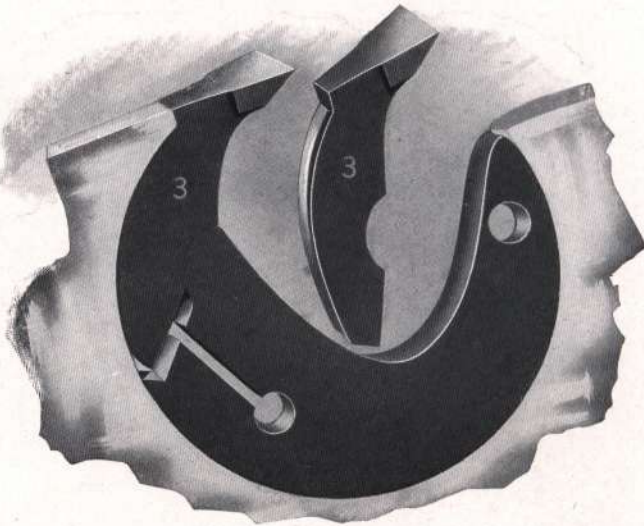

**Full Size of No. 3 Tooth. The Best Tooth for Hard Wood.**

Diameter, Inches.	Thickness, Gauge.	Standard Number of Teeth.	Size Hole, Inches.	List Price.	Extra for Each Additional Gauge Heavier.	Price for Beveling New Saws Per Gauge.	Number Teeth Furnished With Each Saw.
12	11	10	1	\$19 00	\$0 20	\$0 35	100
14	11	10	1 $\frac{1}{8}$	22 00	25	40	100
16	11	12	1 $\frac{1}{8}$	25 50	30	50	100
18	11	14	1 $\frac{1}{4}$	28 50	40	60	100
20	11	14	1 $\frac{1}{8}$	32 00	50	70	100
22	11	16	1 $\frac{1}{8}$	36 50	60	80	100
24	11	18	1 $\frac{3}{8}$	40 00	70	90	100
26	10	18	1 $\frac{3}{8}$	44 00	85	1 05	100
28	10	20	1 $\frac{1}{2}$	48 00.	1 00	1 20	100
30	10	20	1 $\frac{1}{2}$	52 00	1 15	1 30	100
32	9	22	1 $\frac{5}{8}$	58 00	1 30	1 40	200
34	9	22	1 $\frac{5}{8}$	63 00	1 50	1 55	200
36	8	24	1 $\frac{5}{8}$	69 00	1 80	1 70	200
38	8	24	1 $\frac{5}{8}$	74 00	2 00	1 85	200
40	8	26	2	80 00	2 20	2 00	200
42	8	28	2	89 00	2 60	2 20	200
44	7	30	2	96 00	3 00	2 40	200
46	7	30	2	104 00	3 50	2 60	200
48	7	32	2	113 00	4 00	2 80	200
50	7	34	2	127 00	4 50	3 00	200
52	6	36	2	148 00	5 00	3 25	200
54	6	38	2	165 00	6 00	3 50	300
56	6	40	2	180 00	7 00	3 75	300
58	6	42	2	200 00	8 00	4 05	300
60	5	42	2	220 00	9 00	4 35	300
62	5	44	2	245 00	10 00	4 65	300
64	5	44	2	275 00	12 00	5 00	300
66	5	48	2	300 00	15 00	5 35	300
68	5	48	2	325 00	18 00	5 75	300
70	4	52	2	355 00	21 00	6 15	300
72	4	52	2	390 00	24 00	6 55	300

Two extra holders furnished with Saws 40 inches diameter and less. Three extra holders furnished with Saws 42 inches diameter and over.

Duplicate No. 3 holders, 40 cents each. Duplicate No. 3 teeth, \$4.80 per hundred. Wrenches, \$1 00 each.

For changing over Solid Tooth Saws into Inserted Tooth Saws, \$1.50 per tooth, plus one-half the list price of Solid Tooth Saws or same size, this price being based on size the Saw will cut to, and subject to same discount as Inserted Tooth Saws.



## ATKINS INSERTED TOOTH SAWS.

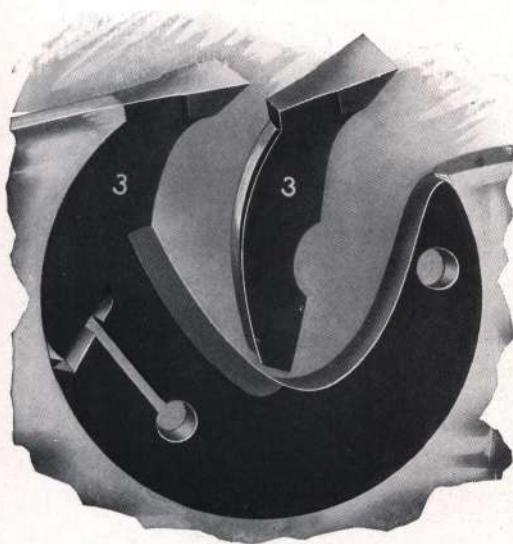

**CHISEL TOOTH No. 3  
SHORT HOLDER  
PATTERN.**

**This Cut shows  
exact size  
of No. 3  
Short  
Holder  
Pattern.**

Unequaled for high speed, heavy  
feed mills, where a large number of  
teeth and plenty of gullet room are  
required.

Diameter, Inches.	Thickness, Gauge.	Standard Number of Teeth.	Size Hole, Inches.	List Price.	Extra for Each Additional Gauge Heavier.	Price for Beveling New Saws Per Gauge.	Number Teeth Furnished With Each Saw.
12	11	10	1	\$19 00	\$0 20	\$0 35	100
14	11	10	1 1/8	22 00	25	40	100
16	11	12	1 1/8	25 50	30	50	100
18	11	14	1 1/4	28 50	40	60	100
20	11	14	1 1/4	32 00	50	70	100
22	11	16	1 1/2	36 50	60	80	100
24	11	18	1 1/2	40 00	70	90	100
26	10	18	1 3/8	44 00	85	1 05	100
28	10	20	1 1/2	48 00	1 00	1 20	100
30	10	20	1 1/2	52 00	1 15	1 30	100
32	9	22	1 3/8	58 00	1 30	1 40	200
31	9	22	1 3/8	63 00	1 50	1 55	200
36	8	24	1 3/8	69 00	1 80	1 70	200
38	8	24	1 3/8	74 00	2 20	1 85	200
40	8	26	2	80 00	2 30	2 00	200
42	8	28	2	89 00	2 60	2 20	200
44	7	30	2	96 00	3 00	2 40	200
46	7	32	2	104 00	3 50	2 60	200
48	7	32	2	113 00	4 00	2 80	200
50	7	34	2	127 00	4 50	3 00	200
52	6	36	2	148 00	5 00	3 25	200
54	6	38	2	165 00	6 00	3 50	300
56	6	40	2	180 00	7 00	3 75	300
58	6	42	2	200 00	8 00	4 05	300
60	5	44	2	220 00	9 00	4 35	300
62	5	44	2	245 00	10 00	4 65	300
64	5	44	2	275 00	12 00	5 00	300
66	5	48	2	300 00	15 00	5 35	300
68	5	48	2	325 00	18 00	5 75	300
70	4	52	2	355 00	21 00	6 15	300
72	4	52	2	390 00	24 00	6 55	300

Two extra holders furnished with Saws 40 inches diameter and less. Three extra holders furnished with Saws 42 inches diameter and over.

Duplicate No. 3 holders, 40 cents each. Duplicate No. 3 teeth, \$4.80 per hundred. Wrenches \$1.00 each.  
For changing over Solid Tooth Saws into Inserted Tooth Saws, \$1.50 per tooth, plus one-half the list price of Solid Tooth Saws of same size, this price being based on size the Saw will cut to, and subject to same discount as Inserted Tooth Saws.

## ATKINS INSERTED TOOTH SAWS.

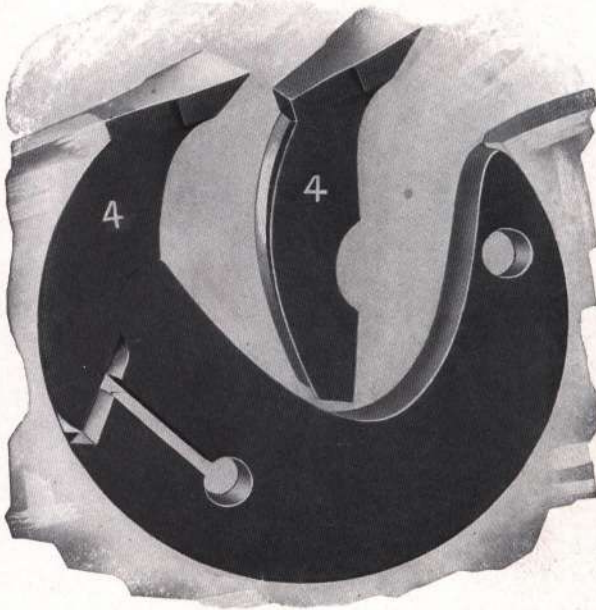

**CHISEL TOOTH  
No. 4.**

**Full Size of No. 4  
Tooth.**

Diameter, Inches.	Thickness, Gauge.	Standard Number of Teeth.	Size Hole, Inches.	List Price.	Extra for Each Additional Gauge Heavier.	Price for Beveling New Saws Per Gauge.	Number Teeth Furnished With Each Saw.
12	11	.....	1	\$19 00	\$0 20	\$0 35	100
14	11	.....	1 $\frac{1}{8}$	22 00	25	40	100
16	11	.....	1 $\frac{1}{4}$	25 50	30	50	100
18	11	.....	1 $\frac{3}{8}$	28 50	40	60	100
20	11	12	1 $\frac{1}{2}$	32 00	50	70	100
22	11	12	1 $\frac{3}{4}$	36 50	60	80	100
24	11	14	1 $\frac{7}{8}$	40 00	70	90	100
26	10	14	1 $\frac{7}{8}$	44 00	85	1 05	100
28	10	16	1 $\frac{1}{2}$	48 00	1 00	1 20	100
30	10	16	1 $\frac{1}{2}$	52 00	1 15	1 30	100
32	9	18	1 $\frac{3}{8}$	58 00	1 30	1 40	200
34	9	20	1 $\frac{3}{8}$	63 00	1 50	1 55	200
36	8	22	1 $\frac{3}{8}$	69 00	1 80	1 70	200
38	8	22	1 $\frac{3}{8}$	74 00	2 00	1 85	200
40	8	24	2	80 00	2 30	2 00	200
42	8	26	2	89 00	2 60	2 20	200
44	7	26	2	96 00	3 00	2 40	200
46	7	28	2	104 00	3 50	2 60	200
48	7	28	2	113 00	4 00	2 80	200
50	7	30	2	127 00	4 50	3 00	200
52	6	30	2	148 00	5 00	3 25	200
54	6	32	2	165 00	6 00	3 50	300
56	6	34	2	180 00	7 00	3 75	300
58	6	34	2	200 00	8 00	4 05	300
60	5	36	2	220 00	9 00	4 35	300
62	5	35	2	245 00	10 00	4 65	300
64	5	33	2	275 00	12 00	5 00	300
66	5	40	2	300 00	15 00	5 35	300
68	5	40	2	325 00	18 00	5 75	300
70	4	42	2	355 00	21 00	6 15	300
72	4	42	2	390 00	24 00	6 55	300

Two extra holders furnished with Saws 40 inches diameter and less. Three extra holders furnished with Saws 42 inches diameter and over.

Duplicate No. 4 holders, 50 cents each. Duplicate No. 4 teeth, \$5.60 per hundred. Wrenches, \$1.00 each.

For changing over Solid Tooth Saws into Inserted Tooth Saws, \$1.50 per tooth, plus one-half the list price of Solid Tooth Saws of same size, this price being based on size the Saw will cut to, and subject to same discount as Inserted Tooth Saws.



## ATKINS INSERTED TOOTH SAWS.

### CHISEL TOOTH No. 4 SHORT HOLDER PATTERN.

**Cut shows exact size of No. 4 Short Holder Pattern, Chisel Bit.**



The Short Holder Patterns are specially adapted for high speed, heavy feed mills, where a large number of teeth and plenty of gullet room is required.

We can furnish the same (Short Holder) pattern in any of the other sizes of Chisel Bit Saws, Nos. 5, 4, 3, 2½, 2.

Diameter, Inches.	Thickness, Gauge.	Standard Number of Teeth.	Size Hole, Inches.	List Price.	Extra for Each Additional Gauge Heavier.	Price for Beveling New Saws Per Gauge.	Number Teeth Furnished With Each Saw.
12	11	.....	1	\$19 00	\$0 20	\$0 35	100
14	11	.....	1½	22 00	25	40	100
16	11	.....	1½	25 50	30	50	100
18	11	.....	1½	28 50	40	60	100
20	11	12	1½	32 00	50	70	100
22	11	12	1½	36 50	60	80	100
24	11	14	1½	40 00	70	90	100
26	10	14	1½	44 00	85	1 05	100
28	10	16	1½	48 00	1 00	1 20	100
30	10	16	1½	52 00	1 15	1 30	100
32	9	18	1½	58 00	1 30	1 40	200
34	9	20	1½	63 00	1 50	1 55	200
36	8	22	1½	69 00	1 80	1 70	200
38	8	22	1½	74 00	2 00	1 85	200
40	8	24	2	80 00	2 30	2 00	200
42	8	26	2	89 00	2 60	2 20	200
44	7	26	2	96 00	3 00	2 40	200
46	7	28	2	104 00	3 50	2 60	200
48	7	28	2	113 00	4 00	2 80	200
50	7	30	2	127 00	4 50	3 00	200
52	6	30	2	148 00	5 00	3 25	200
54	6	32	2	165 00	6 00	3 50	300
56	6	34	2	180 00	7 00	3 75	300
58	6	34	2	200 00	8 00	4 05	300
60	5	36	2	220 00	9 00	4 35	300
62	5	36	2	245 00	10 00	4 65	300
64	5	38	2	275 00	12 00	5 00	300
66	5	40	2	300 00	15 00	5 35	300
68	5	40	2	325 00	18 00	5 75	300
70	4	42	2	355 00	21 00	6 15	300
72	4	42	2	390 00	24 00	6 55	300

Two extra holders furnished with Saws 40 inches diameter and less. Three extra holders furnished with Saws 42 inches diameter and over.

Duplicate No. 4 holders, 50 cents each. Duplicate No. 4 teeth, \$5.60 per hundred. Wrenches, \$1.00 each. For changing over Solid Tooth Saws into Inserted Tooth Saws, \$1.50 per tooth, plus one-half the list price of Solid Tooth Saws of same size, this price being based on size the Saw will cut to, and subject to same discount as Inserted Tooth Saws.

## ATKINS INSERTED TOOTH SAWS.

### CHISEL TOOTH No. 5.

This Cut shows full size of  
No. 5 Tooth.

Especially adapted for use  
on Pacific Coast.



SHORT HOLDER PATTERN.

Diameter, Inches.	Thickness, Gauge.	Standard Number of Teeth.	Size Hole, Inches.	List Price.	Extra for Each Additional Gauge Heavier.	Price for Beveling New Saws Per Gauge.	Number Teeth Furnished With Each Saw.
12	.1	.....	1	\$19 00	\$0 20	\$0 35	100
14	11	.....	1½	22 00	25	40	100
16	11	.....	1½	25 50	30	50	100
18	11	.....	1½	28 50	40	60	100
20	11	.....	1¾	32 00	50	70	100
22	11	.....	1¾	36 50	60	80	100
24	11	.....	1¾	40 00	70	90	100
26	10	.....	1¾	44 00	85	1 05	100
28	10	.....	1½	48 00	1 00	1 20	100
30	10	.....	1½	52 00	1 15	1 30	100
32	9	.....	1½	58 00	1 30	1 40	200
34	9	.....	1½	63 00	1 50	1 55	200
36	8	.....	1½	69 00	1 80	1 70	200
38	8	.....	1½	74 00	2 00	1 85	200
40	8	.....	2	80 00	2 30	2 00	200
42	8	.....	2	89 00	2 60	2 20	200
44	7	.....	2	96 00	3 00	2 40	200
46	7	.....	2	104 00	3 50	2 60	200
48	7	.....	2	113 00	4 00	2 80	200
50	7	.....	2	127 00	4 50	3 00	200
52	6	.....	2	148 00	5 00	3 25	200
54	6	.....	2	165 00	6 00	3 50	300
56	6	.....	2	180 00	7 00	3 75	300
58	6	.....	2	200 00	8 00	4 05	300
60	5	.....	2	220 00	9 00	4 35	300
62	5	.....	2	245 00	10 00	4 65	300
64	5	.....	2	275 00	12 00	5 00	300
66	5	.....	2	300 00	15 00	5 35	300
68	5	.....	2	325 00	18 00	5 75	300
70	4	.....	2	355 00	21 00	6 15	300
72	4	.....	2	390 00	24 00	6 55	300

Two extra holders are furnished with Saws 40 inches diameter and less. Three extra holders furnished with Saws 42 inches diameter and over.

Duplicate No. 5 holders, 50 cents each. Duplicate No. 5 teeth, \$6.00 per hundred. Wrenches, \$1.00 each.

For changing over Solid Tooth Saws into Inserted Tooth Saws, \$1.50 per tooth, plus one-half the list price of Solid Tooth Saws of same size, this price being based on size the Saw will cut to, and subject to same discount as Inserted Tooth Saws.



## ATKINS RIFT SAWS.

### WITH CHISEL TOOTH No. 3.

Fifty points and one extra holder furnished with each Saw.



Diameter.	Gauge.	Four Teeth.	Six Teeth.
14	8	\$15 00	\$18 00
16	8	16 00	19 00
18	8	18 00	21 00
20	8	20 00	23 00
22	8	22 00	25 00
24	8	24 50	27 50
26	8	27 00	30 00
28	8	30 00	33 00
30	8	34 00	37 00

Eight gauge is standard. Can furnish 9 or 10 gauge. In ordering be particular to send templet of holes.

Duplicate No. 3 teeth, list, \$4.80 per hundred. Duplicate No. 3 holders, list, 40 cents each. Wrenches, list, \$1.00 each.

## ATKINS IMPROVED PATENT INSERTED TOOTH SAW WRENCHES.

The most perfect wrench yet devised. Can be quickly adjusted to holder. Easy to operate.



**No. 1.**

For Nos. 3, 4 and 5 Holders.



**No. 2.**

For Nos. 2 and 2½ Holders.

List price, each, \$1.00.

In ordering Wrenches, specify style and number of Tooth.

## Atkins Silver-Steel Band Saws

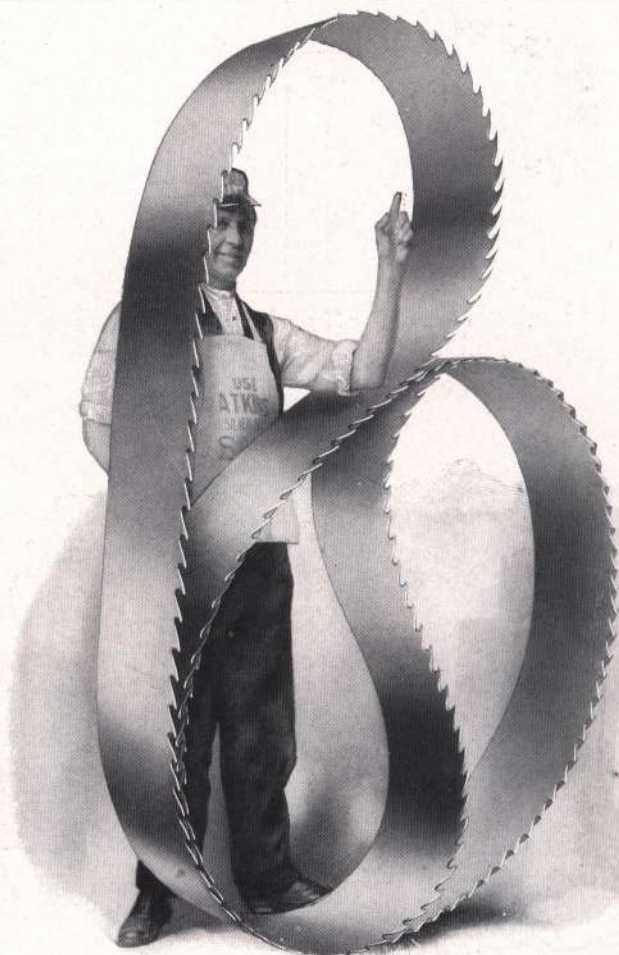

### WITH TEETH ON ONE OR BOTH EDGES.

As pioneers in the manufacture of Band Saws, having made a SPECIALTY of this branch of saw making ever since the advent of the band mill as the modern method of manufacturing lumber, we have, by virtue of our long experience, acquired knowledge of the requirements of mill bands as to steel, temper and pattern of tooth, that has won for us an enviable reputation among users of this class of saws.

We are now enjoying the patronage of a majority of the leading band mills throughout the country. Atkins Silver-Steel Bands are producing results not obtained from other bands in the market.

Our success in this department is due to the use of Atkins Silver-Steel, the toughest and most flexible steel made, the latest improved machinery, the employment of skilled mechanics and our facilities for securing absolute uniformity of temper.



**ATKINS SILVER-STEEL BAND SAWS.**  
TRADE MARK

**FOR LOG MILLS AND RE-SAWING MACHINES.**

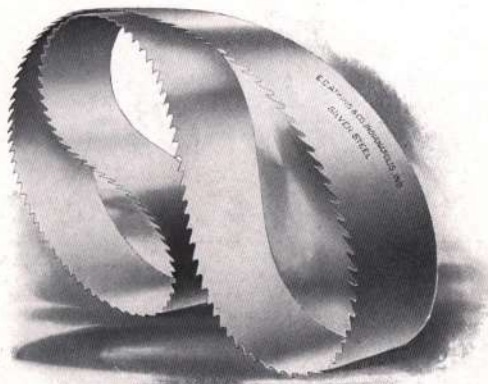

**UNIFORM TEMPER AND TENSION.**

**The Atkins Silver-Steel Bands Give the Best Results.**  
TRADE MARK

**WIDE BAND SAWS.**

Width, Inches.	Usual Gauge.	Price Per Foot.	Width, Inches.	Usual Gauge.	Price Per Foot.
2	18 to 20	\$0 80	9	14 to 16	\$3 60
2½	18 to 20	1 00	10	14 to 16	4 00
3	18 to 20	1 20	11	14 to 16	4 50
3½	18 to 20	1 40	12	13 to 15	5 00
4	17 to 19	1 60	13	13 to 15	6 00
4½	17 to 19	1 80	14	13 to 15	7 00
5	17 to 19	2 00	15	12 to 14	8 50
5½	17 to 19	2 20	16	12 to 14	10 00
6	17 to 19	2 40	17	12 to 14	14 00
7	16 to 18	2 80	18	12 to 14	18 00
8	14 to 16	3 20			

Saws of odd widths, not listed, take price of next wider size listed.

For Saws of heavier gauge than listed add 5 per cent to list for each gauge heavier.

No extra charge for Saws one or two gauges thinner than list; when more than two gauges thinner add 5 per cent to list for each gauge.

**DOUBLE EDGE BAND SAWS.** List price per foot, all widths, advance 10 per cent over list prices of Single Edge Saws as above.

**TOOTHED BLANKS.** Same price as finished Saws.

**BAND SAW BLANKS.** Bright, of any width, furnished to order but not warranted.

# — ATKINS SILVER STEEL SAWS —

## ATKINS NARROW BAND SAWS. FOR RE-SAWING AND SCROLL SAWING.

NOTE—These saws are not joined, set and filed unless so ordered.

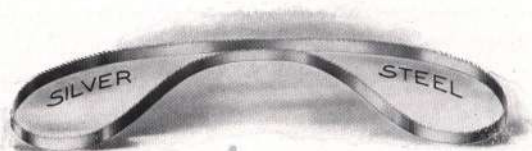

### Price List, Not Joined, Filed or Set.

Width, Inches.	Standard Gauge.	Standard Teeth, Points.	Per Foot, Cents.	Width, Inches.	Standard Gauge	Standard Teeth, Points.	Per Foot, Cents.
$\frac{1}{8}$	23	8	7	$\frac{7}{8}$	21	4	17
$\frac{3}{16}$	23	7	8	1	20	$3\frac{1}{2}$	19
$\frac{1}{4}$	22	6	9	$1\frac{1}{8}$	20	$3\frac{1}{2}$	21
$\frac{5}{16}$	22	$5\frac{1}{2}$	10	$1\frac{1}{4}$	20	$3\frac{1}{2}$	23
$\frac{1}{2}$	21	5	11	$1\frac{3}{8}$	20	3	26
$\frac{5}{8}$	21	$4\frac{1}{2}$	13	$1\frac{1}{2}$	20	3	29
$\frac{3}{4}$	21	4	15	$1\frac{3}{4}$	20	3	32

Filing and setting 4 cents per foot extra.

Narrow Band Saws with beveled backs, advance list 50 per cent. for first gauge and 10 per cent. for each additional gauge.

For Band Saws with Knife Edge, add 10 cents per foot to list. We make a specialty of Band Saws in coils, any length desired.

### BRAZING.

$\frac{1}{4}$ to $\frac{1}{2}$ -inch.....	\$0 40	$1\frac{3}{4}$ -inch.....	\$0 90
$\frac{5}{8}$ to $\frac{3}{4}$ -inch.....	50	2 -inch.....	1 00
1 to $1\frac{1}{4}$ -inch.....	60	$2\frac{1}{2}$ -inch.....	1 25
$1\frac{3}{8}$ to $1\frac{1}{2}$ -inch.....	80		

### APPROXIMATE WEIGHTS OF ENDLESS RUBBER BANDS FOR BAND SAW WHEELS.

Diameter of Wheels, Inches.	Width, Inches.	Pounds.	Ounces.	Diameter of Wheels, Inches.	Width, Inches.	Pounds.	Ounces.	Diameter of Wheels, Inches.	Width, Inches.	Pounds.	Ounces.
22	$1\frac{1}{2}$	1	4	26	2	1	14	36	$2\frac{1}{4}$	2	11
24	$1\frac{1}{2}$	1	6	28	2	2	0	38	$2\frac{1}{4}$	2	13
26	$1\frac{1}{2}$	1	8	30	2	2	2	40	$2\frac{1}{4}$	2	15
28	$1\frac{1}{2}$	1	10	32	2	2	4	42	$2\frac{1}{4}$	3	1
30	$1\frac{1}{2}$	1	12	34	2	2	6	30	$2\frac{1}{2}$	2	8
24	$1\frac{3}{4}$	1	9	36	2	2	8	32	$2\frac{1}{2}$	2	10
26	$1\frac{3}{4}$	1	11	38	2	2	10	34	$2\frac{1}{2}$	2	12
28	$1\frac{3}{4}$	1	13	40	2	2	12	36	$2\frac{1}{2}$	2	14
30	$1\frac{3}{4}$	1	15	30	$2\frac{1}{4}$	2	5	38	$2\frac{1}{2}$	3	0
32	$1\frac{3}{4}$	2	1	32	$2\frac{1}{4}$	2	7	40	$2\frac{1}{2}$	3	2
34	$1\frac{3}{4}$	2	3	34	$2\frac{1}{4}$	2	9	42	$2\frac{1}{2}$	3	4
36	$1\frac{3}{4}$	2	5								

Above table is based on bands  $\frac{3}{16}$  inch thick, which is the standard. For  $\frac{1}{4}$  inch thick add one-third. These weights are approximate and are subject to a slight variation.

Prices quoted on application.



**A FEW PATTERNS OF TEETH USED IN  
ATKINS BAND SAWS.**

When ordering Band Saws, if any of the Patterns here shown are desired, kindly refer to "Letter" designating Style of Tooth.

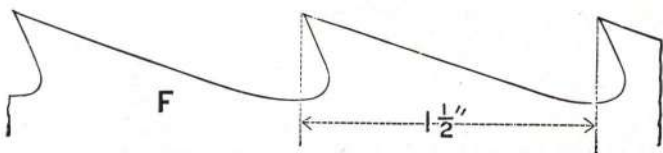
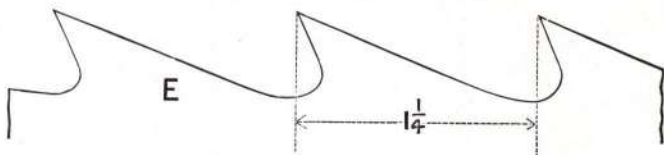
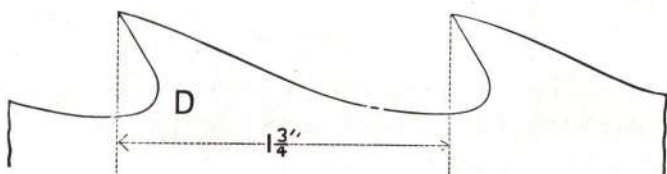
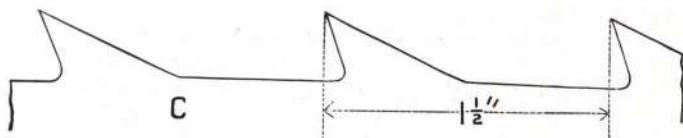
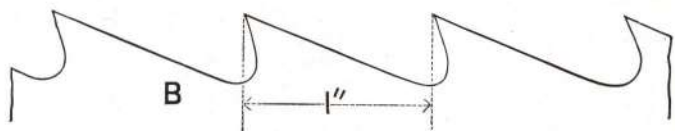
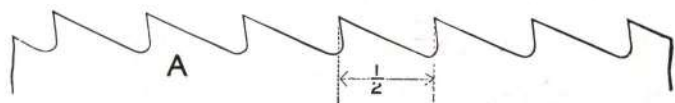

## A FEW PATTERNS OF TEETH USED IN ATKINS BAND SAWS—Cont'd.

When ordering Band Saws, if any of the Patterns here shown are desired, kindly refer to "Letter" designating Style of Tooth.

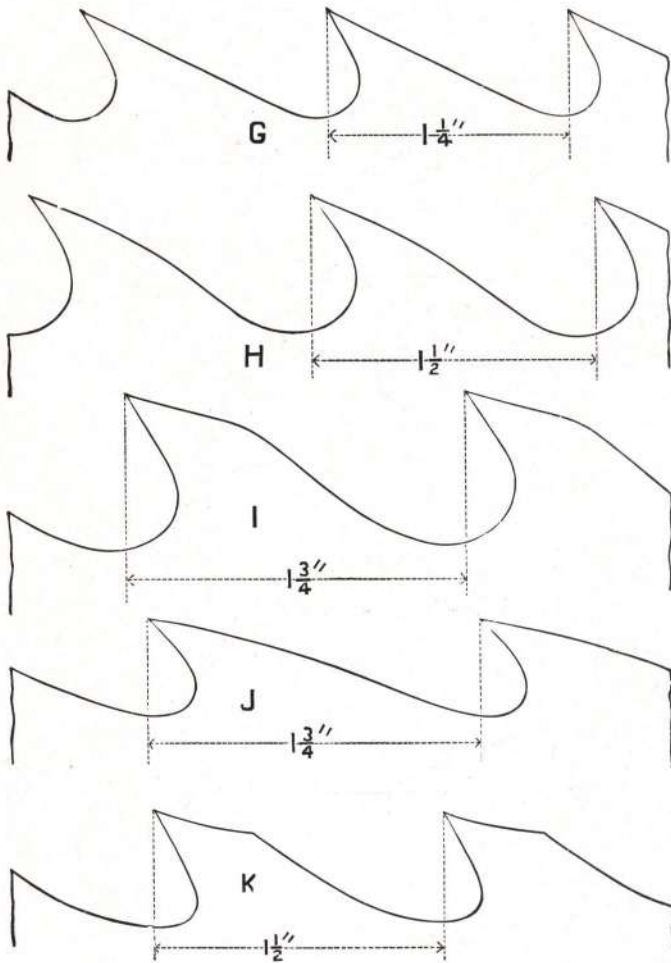



**A FEW PATTERNS OF TEETH USED IN  
ATKINS BAND SAWS—Cont'd.**

When ordering Band Saws, if any of the Patterns here shown are desired, kindly refer to "Letter" designating Style of Tooth.

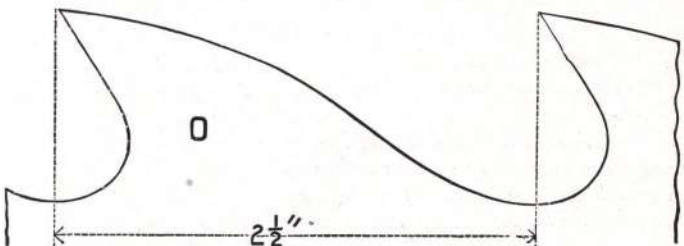
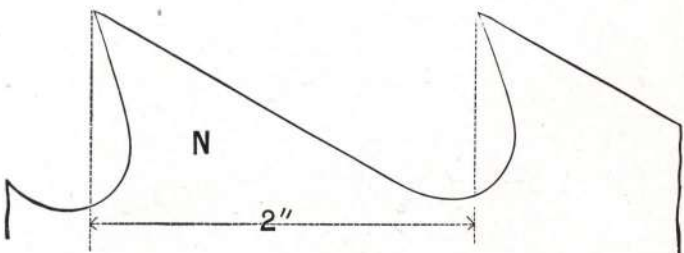
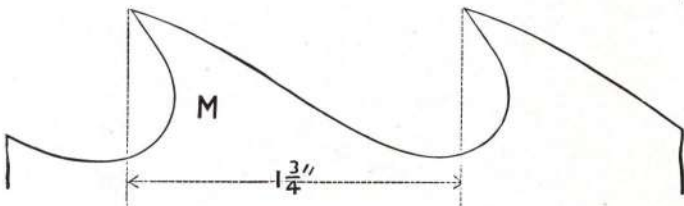
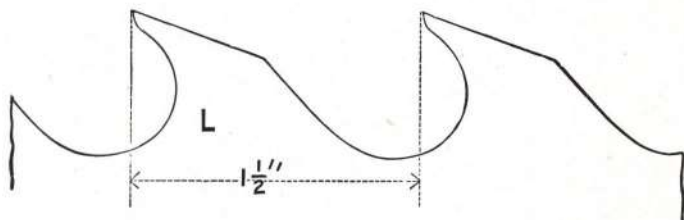

## ATKINS SILVER-STEEL GANG SAWS.

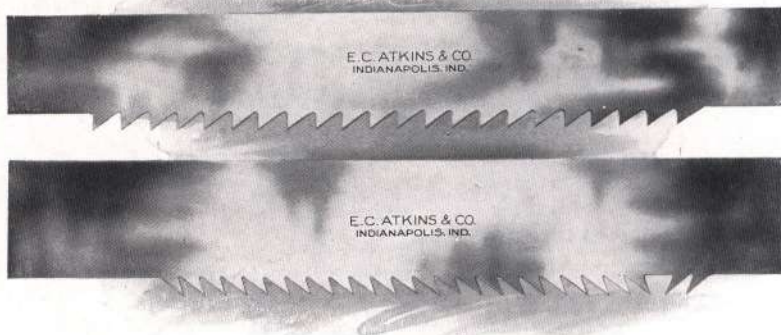

### Price List.

Width Inches.	8 Gauge.	9 Gauge.	10 Gauge.	11 Gauge.	12 Gauge.	13 Gauge.	14 Gauge.	15 Gauge.	16 Gauge.
10	\$2 50	\$2 35	\$2 10	\$2 00	\$1 90	\$1 80	\$1 70	\$1 60	
9	2 15	2 05	1 95	1 85	1 75	1 65	1 55	1 50	
8	2 00	1 90	1 80	1 70	1 60	1 50	1 40	1 35	\$1 30
7	.....	.....	.....	.....	.....	1 40	1 30	1 25	1 20
6	.....	.....	.....	.....	.....	1 25	1 20	1 15	1 10
5	.....	.....	.....	.....	.....	1 15	1 10	1 05	1 00
4	.....	.....	.....	.....	.....	1 10	1 05	1 00	95

If swaged only, add 5 cents per foot to list. If fitted for use, add 10 cents per foot to list.

## GANG RIFT SAW.



Gang Saws with reversed teeth add 10 per cent to list prices.

Tabbing with solid bent tabs or two plate tabs, 4 hole 40 cents, 5 hole 50 cents, 6 hole 60 cents per saw, net.

Tabbing with solid round tabs 50 cents per saw, net.

Punching Gang Saws for tabs, 1 cent per hole, net.

If swaged only add 5 cents per foot to list price.

Is swaged and fitted ready for use add 10 cents per foot to list price.

When ordering Gang Saws give length, thickness by gauge, shape and space of teeth, number of teeth in saw and distance from lower end of saw to point of first tooth. WHEN SAWS ARE TO BE TABBED, EXACT DISTANCE BETWEEN TABS MUST BE GIVEN.



## ATKINS SILVER-STEEL DRAG SAWS.



**Single Hook.**



**Mill Tooth.**



**Tuttle Tooth.**

### BUTTING OR DRAG SAWS

Width, Inches.	THICKNESS			
	10 Gauge.	11 Gauge.	12 Gauge.	13 Gauge.
Tapered 8 inch butt, 6 inch point.....	\$1 25	\$1 20	\$1 20	\$1 20
“ 7 “ “ 5 “ “ .....	1 15	1 10	1 05	1 05
“ 6 “ “ 4 “ “ .....	1 05	1 00	95	95

Tapered Drag Saws wider or thicker than above will be figured by the Mill, Mulay and Drag Saw list, using the average width as the basis.

If filed and fitted add to list for 10 gauge and heavier, 30 cents per foot, 11 gauge and thinner, 15 cents per foot.



### MILL SAWS, MULAY SAWS, LANCE TOOTH DRAG SAWS AND DRAG SAWS OF EQUAL WIDTH.

#### List Prices,

Width, Inches.	4 Gauge.	5 Gauge.	6 Gauge.	7 Gauge.	8 Gauge.	9 Gauge.	10 Gauge
16.....	\$6 60	\$6 20	\$5 70	\$5 20	\$4 80	\$4 40	\$4 00
14.....	5 60	5 20	4 80	4 40	4 00	3 60	3 30
12.....	4 80	4 40	4 00	3 60	3 30	3 00	2 70
11.....	4 30	4 00	3 70	3 30	3 00	2 70	2 40
10.....	3 90	3 60	3 30	3 00	2 70	2 40	2 20
9.....	3 60	3 30	3 00	2 70	2 40	2 20	2 00
8.....	3 30	3 00	2 70	2 40	2 20	2 00	1 80

List prices are for saws with Plain, Mill, Champion or Lance tooth. Saws with special patterns of teeth, special prices.

If Saws are set and sharpened, add to list price as follows: 5 gauge and thicker 40 cents per foot. 6 to 10 gauge inclusive 30 cents per foot.

When ordering Mill, Mulay or Drag Saws give length, width, thickness by gauge, style of teeth, space from point to point of teeth and distance from end of Saw to point of first tooth. It Saws are to be drilled, send full size pattern showing position of holes.

## ATKINS SILVER-STEEL MULAY SAWS.



Width, Inches.	4 Gauge.	5 Gauge.	6 Gauge.	7 Gauge.	8 Gauge.	9 Gauge.	10 Gauge.
16.....	\$6 60	\$6 20	\$5 70	\$5 20	\$4 80	\$4 40	\$4 00
14.....	5 60	5 20	4 80	4 40	4 00	3 60	3 30
12.....	4 80	4 40	4 00	3 60	3 30	3 00	2 70
11.....	4 30	4 00	3 70	3 30	3 00	2 70	2 40
10.....	3 90	3 60	3 30	3 00	2 70	2 40	2 20

## SILVER-STEEL MULAY SAWS FOR THE CHANDLER @ TAYLOR SIDE-CUTTING MULAY SAW MILL.



Width, Inches.	4 Gauge.	5 Gauge.	6 Gauge.	7 Gauge.	8 Gauge.	9 Gauge.	10 Gauge.
9.....	\$3 60	\$3 30	\$3 00	\$2 70	\$2 40	\$2 20	\$2 00

## SILVER-STEEL MILL SAWS.



Width, Inches.	4 Gauge.	5 Gauge.	6 Gauge.	7 Gauge.	8 Gauge.	9 Gauge.	10 Gauge.
8.....	\$3 30	\$3 00	\$2 70	\$2 40	\$2 20	\$2 00	\$1 80

In ordering Mulay and Mill Saws, state length, width, gauge and distance from point to point of teeth.



**ATKINS TILLERS AND BOXES  
FOR PIT SAWS COMPLETE.**

Price, \$2.25. 2/0.

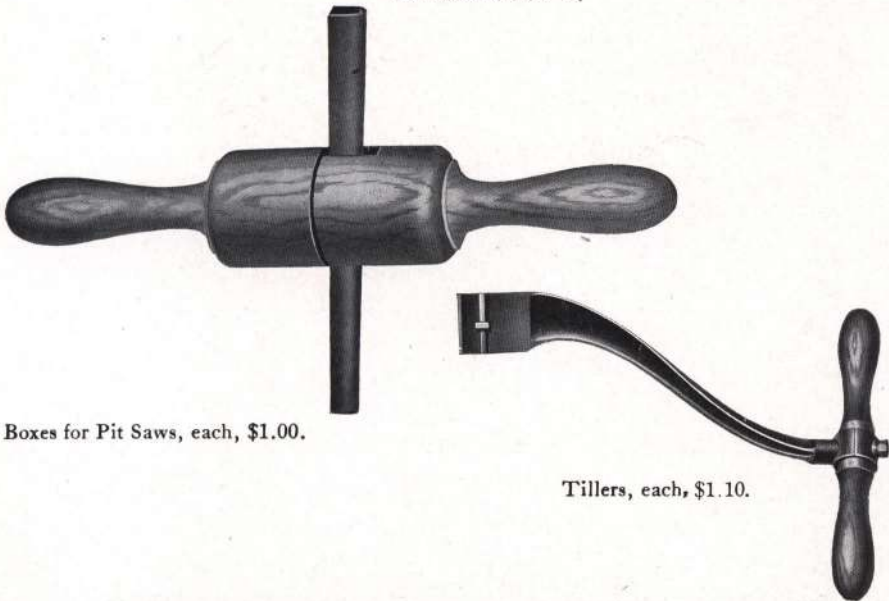

Boxes for Pit Saws, each, \$1.00.

Tillers, each, \$1.10.

**SILVER-STEEL PIT SAWS.**



Length, 14 x 16 gauge .....	5 ft.	5½ ft.	6 ft.	6½ ft.	7 ft.	7½ ft.	8 ft.
Price, each.....	\$5 00	5 50	6 00	6 50	7 00	7 50	8 00
Point.....	4-in.	4-in.	4-in.	4-in.	4-in.	4-in.	4-in.
Butt.....	10-in.	10½-in.	11-in.	11½-in.	12-in.	12½-in.	13-in.

**SILVER-STEEL WHIP SAWS.**



Lengths.....	5 ft.	5½ ft.	6 ft.	6½ ft.	7 ft.	7½ ft.
Price, each.....	\$3 00	3 30	3 60	3 90	4 20	4 50

## R e p a i r i n g

We desire to call special attention to our facilities for repairing saws of every description. This branch of our business has assumed large proportions. With improved machinery and appliances, expert workmen, careful attention to details and prompt return of work, we are prepared to guarantee the best service and perfect satisfaction. This is true not only with reference to our factory, but also our branch houses, Memphis, New Orleans, Atlanta, Minneapolis, Portland and Seattle, each of which is furnished with a thoroughly equipped repair shop and competent workmen.

In sending saws for repairs, please observe the following directions:—

- (a) Mark **our** name and address plainly on package.
- (b) Sender should mark **his** name and address plainly on package so that we can identify it.
- (c) Advise us of shipment by mail.
- (d) Send us full instructions by mail.

### **Breakage in repairing at owner's risk.**

We make a specialty of repairing Cylinder Saws.



## REPAIRING SOLID TOOTH CIRCULAR SAWS.

Diameter, Inches.	Hammering Only.	Gumming and Hammering.	Cutting-down Retooling and Hammering.	Grinding First Gauge.	Grinding Addi- tional Gauges Each Gauge.
4	\$ 0 30	\$ 0 45	\$ 0 60	\$ 0 55	\$ 0 25
5	35	50	65	60	30
6	45	55	75	65	35
7	50	65	85	75	45
8	55	75	1 00	85	55
9	65	85	1 15	95	65
10	75	1 00	1 30	1 05	75
12	90	1 35	1 60	1 15	85
14	1 05	1 60	1 90	1 35	1 00
16	1 20	1 80	2 20	1 60	1 15
18	1 45	2 10	2 55	1 95	1 30
20	1 65	2 50	2 95	2 20	1 45
22	1 90	2 85	3 30	2 40	1 60
24	2 10	3 25	3 70	2 70	1 75
26	2 40	3 70	4 20	3 00	1 90
28	2 70	4 15	4 75	3 40	2 05
30	3 00	4 60	5 35	3 75	2 20
32	3 30	5 05	6 00	4 15	2 35
34	3 70	5 55	6 90	4 50	2 55
36	4 30	6 15	7 80	4 90	2 80
38	4 80	7 00	9 00	5 25	3 00
40	5 55	8 05	10 20	5 65	3 30
42	6 30	9 15	11 55	6 00	3 60
44	7 05	10 35	13 05	6 45	4 05
46	7 95	11 80	14 70	7 00	4 50
48	8 85	13 20	16 50	7 60	4 95
50	9 75	14 65	18 40	8 25	5 40
52	10 65	16 05	20 25	9 00	5 95
54	11 55	17 55	22 15	9 90	6 30
56	12 45	19 05	24 00	10 90	6 75
58	13 50	20 70	25 90	12 00	7 20
60	14 70	22 50	27 75	13 20	7 75
62	15 90	24 30	30 40	14 40	8 25
64	17 10	26 10	33 00	15 60	8 85
66	18 30	27 90	35 65	16 80	9 45
68	19 50	29 70	38 25	18 00	10 15
70	20 70	31 50	40 90	19 50	11 05
72	21 90	33 30	43 50	21 00	12 00
74	23 10	35 10	46 15	22 50	13 15

In sending us saws for repairs, mark our address in full upon the package; also give address of party sending it and what Station and State shipped from, so that we can identify on arrival.

## TAPER GROUND SHINGLE, HEADING AND RE-SAWS.

	46-inch and under.	48-inch and over.
Hammered, per inch in diameter.....	\$0 20	\$0 25
Gummed and Hammered, per inch in diameter.....	28	38
Retooled and Hammered, per inch in diameter.....	38	50
Grinding, first gauge, per inch in diameter.....	08	10
Grinding additional gauges, per inch in diameter.....	05	08

## BURNED SAWS.

The temper of burned saws can generally be restored. We make a specialty of this class of work, and rarely fail to make such saws as good as new. We undertake the work at the owner's risk, though no charge will be made by us in case of failure. Please prepay freight on all such saws.

### RE-TEMPERING AND RE-FITTING BURNED SOLID TOOTH CIRCULAR SAWS.

(INCLUDING TEMPERING, GRINDING, POLISHING, GUMMING AND HAMMERING.)

Size, Inches.	Price, Each.	Size, Inches.	Price, Each.	Size, Inches.	Price, Each.
30	\$14 00	44	\$36 65	58	\$90 00
32	16 00	46	43 35	60	100 00
34	18 10	48	50 00	62	113 35
36	20 65	50	56 65	64	126 65
38	23 35	52	63 35	66	140 00
40	27 35	54	70 00	68	156 65
42	31 35	56	80 00	70	176 65

All sizes under 30 inches two-thirds list price for Circular Saws.

Prices for re-tempering Chisel Bit Saws quoted on application.

## REPAIRING LONG SAWS, CROSS-CUT AND BAND SAWS.

### MILL, MULAY AND EQUAL WIDTH DRAG SAWS.

	To 5 Feet.	Over 5 Feet.
Re-Toothing and Hammering.....	each, \$1 50	\$2 00
Hammering only.....	each, 1 00	1 50

### TAPER DRAG SAWS.

Re-Toothing, Hammering and Filing.....	each, \$2 00
Hammering only.....	" 1 00
Setting and Sharpening only.....	" 1 00
Re-Toothing and Hammering only.....	" 1 50

### CROSS-CUT SAWS.

Hammering.....	each, \$0 70
Gumming and Hammering.....	" 1 00
Gumming, Hammering and Filing.....	" 1 50
Re-Toothing, Hammering and Filing.....	" 2 00
Setting and Sharpening only.....	" 70
Skim and Polish.....	" 50

### BAND SAW BLADES.

Brazing wide blade for Log Mill.....	50 cents per inch in width.
Hammering.....	5 cents per foot per inch in width.
Gumming and Toothing.....	8 cents per running foot.
Filing and Swaging.....	8 cents per running foot.

**Cylinder Saws Repaired and Re-Steelled. Satisfaction Guaranteed.**



## ATKINS BARREL STAVE SAWS.

We manufacture Cylinder Saws, complete, comprising Cylinder, Steel, Head and Arbor. They are made from the highest grade of crucible steel, ground and tempered by our patented processes. Every Saw fully warranted. Prices quoted on application.



### List Prices for Re-Steeling Straight Drum Cylinder Saws.

Diameter, Inches.	Length of Steel, Inches.	List Prices.	Diameter, Inches.	Length of Steel, Inches.	List Prices.
6	6	\$26 00	14	6	\$43 00
7	6	27 00	15	6	46 00
8	6	28 00	16	6	49 00
9	6	30 00	18	8	56 00
10	6	32 00	20	8	64 00
11	6	34 00	22	9	72 00
12	6	37 00	24	9	84 00
13	6	40 00	26	10	100 00

Atkins Ideal Swage specially adapted for Cylinder Saws. See page 210 for prices.

## BILGE SAWS.



Bilge Saws made to order. Prices quoted on receipt of specifications. Re-Steeling Bilge Saws, List \$60.00. Price for re-steeling includes all ordinary truing and balancing.

**GROOVER OR DADO HEAD.  
HUTHER'S PATENT.**

**Jointed and Filed, Ready for Use.**

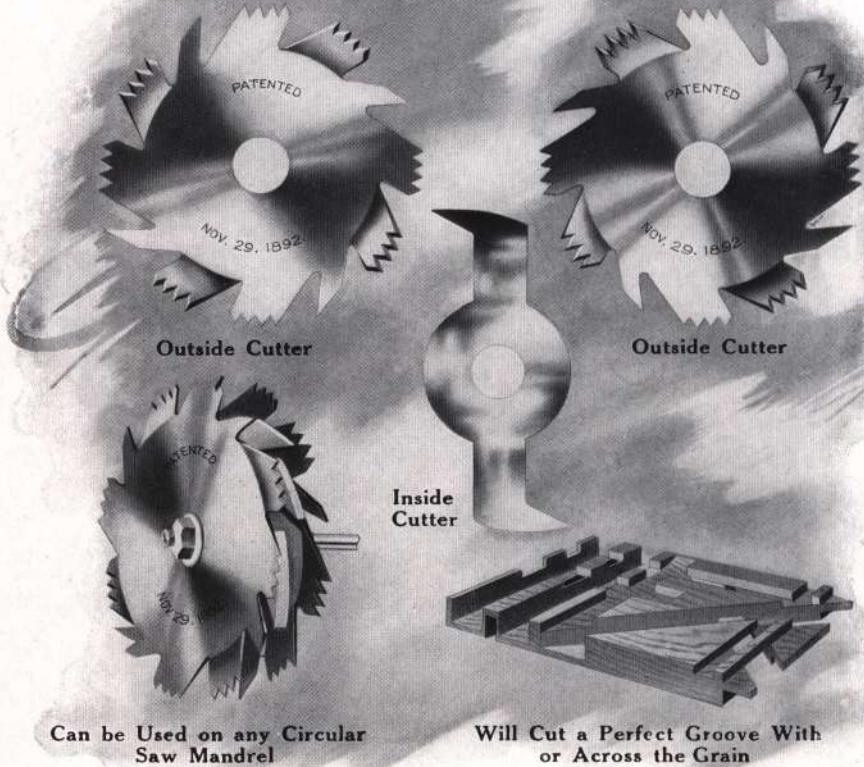

Can be Used on any Circular Saw Mandrel

Will Cut a Perfect Groove With or Across the Grain

**Prices Net—Not Subject to Discount.**

For cutting any width groove, from  $\frac{1}{8}$  inch to 2 inches or over.

This groover consists of two outside saws, each of which is a groover in itself, and as many inside cutters as required.

The inside cutters are made  $\frac{1}{8}$ ,  $\frac{1}{8}$  and  $\frac{1}{4}$  inch thick, so that any width groove measurable in sixteenths may be cut.

The outside cutters are made  $\frac{1}{8}$  inch thick.

It will cut a perfect groove, either with or across the grain, and will not leave a rough edge, as is the case with ordinary groovers.

This tool is recommended to any person in need of a perfect groover, Dado or Gaining Head.

The outside cutters can be used singly, together, or in connection with as many or as few inside cutters as required to cut the necessary width groove.

We will guarantee to sell you the best Dado on the market, and will send on approval to any responsible party, and if not satisfactory in every respect it can be returned at our expense.



## GROOVER OR DADO HEAD.

### HUTHER'S PATENT.

The groovers are arranged in sets, as follows :

- No. 1 Set, cutting grooves,  $\frac{1}{8}$ ,  $\frac{1}{4}$ ,  $\frac{3}{8}$ .
- No. 2 " " "  $\frac{1}{8}$ ,  $\frac{1}{4}$ ,  $\frac{3}{8}$ ,  $\frac{1}{2}$ ,  $\frac{5}{8}$ .
- No. 3 " " "  $\frac{1}{8}$ ,  $\frac{1}{4}$ ,  $\frac{5}{16}$ ,  $\frac{3}{8}$ ,  $\frac{7}{16}$ ,  $\frac{1}{2}$ ,  $\frac{9}{16}$ ,  $\frac{5}{8}$ ,  $\frac{11}{16}$ ,  $\frac{3}{4}$ .
- No. 4 " " "  $\frac{1}{8}$ ,  $\frac{1}{4}$ ,  $\frac{5}{16}$ ,  $\frac{3}{8}$ ,  $\frac{7}{16}$ ,  $\frac{1}{2}$ ,  $\frac{9}{16}$ ,  $\frac{5}{8}$ ,  $\frac{11}{16}$ ,  $\frac{3}{4}$ ,  $\frac{13}{16}$ ,  $\frac{7}{8}$ ,  $\frac{15}{16}$ , 1.
- No. 5 " " "  $\frac{1}{8}$ ,  $\frac{1}{4}$ ,  $\frac{5}{16}$ ,  $\frac{3}{8}$ ,  $\frac{7}{16}$ ,  $\frac{1}{2}$ ,  $\frac{9}{16}$ ,  $\frac{5}{8}$ ,  $\frac{11}{16}$ ,  $\frac{3}{4}$ ,  $\frac{13}{16}$ ,  $\frac{7}{8}$ ,  $\frac{15}{16}$ , 1,  $1\frac{1}{16}$ ,  $1\frac{1}{8}$ ,  $1\frac{3}{8}$ ,  $1\frac{1}{4}$ ,  $1\frac{5}{16}$ ,  $1\frac{3}{8}$ ,  $1\frac{7}{16}$ ,  $1\frac{1}{2}$ .
- No. 6 " " "  $\frac{1}{8}$ ,  $\frac{1}{4}$ ,  $\frac{5}{16}$ ,  $\frac{3}{8}$ ,  $\frac{7}{16}$ ,  $\frac{1}{2}$ ,  $\frac{9}{16}$ ,  $\frac{5}{8}$ ,  $\frac{11}{16}$ ,  $\frac{3}{4}$ ,  $\frac{13}{16}$ ,  $\frac{7}{8}$ ,  $\frac{15}{16}$ , 1,  $1\frac{1}{16}$ ,  $1\frac{1}{8}$ ,  $1\frac{3}{8}$ ,  $1\frac{1}{4}$ ,  $1\frac{5}{16}$ ,  $1\frac{3}{8}$ ,  $1\frac{7}{16}$ ,  $1\frac{1}{2}$ ,  $1\frac{9}{16}$ ,  $1\frac{5}{8}$ ,  $1\frac{11}{16}$ ,  $1\frac{3}{4}$ ,  $1\frac{13}{16}$ ,  $1\frac{7}{8}$ ,  $1\frac{15}{16}$ , 2.

### Price List of Groovers.

	6 In. Diam.	7 In. Diam.	8 In. Diam.	9 In. Diam.	10 In. Diam.	11 In. Diam.	12 In. Diam.	14 In. Diam.	16 In. Diam.	18 In. Diam.	20 In. Diam.
No. 1 Set....	\$5 80	\$6 80	\$7 60	\$8 35	\$9 15	\$9 75	\$10 85	\$13 30	\$15 80	\$18 30	\$19 80
No. 2 Set....	7 05	8 15	9 05	9 90	10 80	11 60	12 95	15 40	17 90	20 40	22 90
No. 3 Set....	8 65	9 85	10 85	11 90	13 00	13 90	15 45	18 00	20 50	23 00	25 50
No. 4 Set....	9 90	11 20	12 30	13 45	14 65	15 75	17 55	20 00	22 50	25 00	27 50
No. 5 Set....	12 40	13 90	15 20	16 55	17 95	19 45	21 75	24 25	26 75	29 25	31 75
No. 6 Set....	14 90	16 60	18 10	19 65	21 25	23 15	25 95	28 50	31 00	33 50	36 00

### INSIDE CUTTERS.

### OUTSIDE CUTTERS.

Diam. Inches	$\frac{1}{8}$	$\frac{3}{8}$	$\frac{1}{2}$ or $\frac{3}{4}$	Diam. Inches	$\frac{1}{8}$	$\frac{3}{8}$	$\frac{1}{2}$
6	\$0 65	\$1 00	\$1 40	6	\$2 95	\$3 50	\$4 00
7	70	1 10	1 50	7	3 40	4 00	4 60
8	80	1 20	1 60	8	3 85	4 45	5 05
9	90	1 30	1 70	9	4 30	4 90	5 50
10	1 00	1 40	1 80	10	4 75	5 35	6 00
11	1 10	1 50	1 90	11	5 10	5 80	6 50
12	1 20	1 60	2 10	12	6 05	6 65	7 00

In ordering, please state the number of set, diameter of groover, and size of hole wanted. Extra inside cutters can be had at any time.

ATKINS ICE SAWS.



POND ICE SAW. WITHOUT TILLER, STANDARD LENGTH 5 FEET.

Width	Thickness	Length, Feet....	3	3 1/2	4	4 1/2	5	5 1/2	6
8-inch Butt	10 Gauge	.....	\$3 00	3 50	4 00	4 50	5 00	5 50	6 00
8-inch Butt	11 Gauge	.....	2 80	3 25	3 80	4 25	4 70	5 15	5 70
7-inch Butt	10 Gauge	.....	2 70	3 15	3 60	4 05	4 50	4 95	5 40
7-inch Butt	11 Gauge	.....	2 55	2 95	3 40	3 85	4 25	4 70	5 10

Tiller Handles, each, \$1.10 List.

HAND ICE SAWS.

For Wagon Use. Set and Sharpened.



HOLLOW BACK HAND ICE SAW.

24 inches.....	Per dozen, \$14 00
26 "	" 15 00
28 "	" 16 00
30 "	" 17 00
32 "	" 18 00
34 "	" 19 00
36 "	" 20 00



HAND ICE SAW.  
With Iron Handles.

24 inches.....	Per dozen, \$20 00
26 "	" 21 00
28 "	" 22 00
30 "	" 23 00
32 "	" 24 00
34 "	" 25 00
36 "	" 26 00

Ice Saws with Beech Handles same price as above.  
Packed one-half dozen in package.



## ATKINS FELLOE WEBS.



### List Price.

Inches.	Gauge.	Width.	Per Dozen.	Inches.	Gauge.	Width.	Per Dozen.
6	19	$\frac{3}{16}$ to $\frac{1}{2}$	\$1 50	22	17	$\frac{1}{4}$ to $\frac{3}{8}$	\$3 85
7	19	$\frac{3}{16}$ to $\frac{1}{2}$	1 60	24	17	$\frac{1}{4}$ to $\frac{3}{8}$	4 25
8	19	$\frac{3}{16}$ to $\frac{1}{2}$	1 70	26	17	$\frac{1}{4}$ to $\frac{3}{8}$	4 65
10	18	$\frac{3}{16}$ to $\frac{1}{2}$	1 90	28	17	$\frac{1}{4}$ to 1	5 15
12	18	$\frac{1}{4}$ to $\frac{1}{2}$	2 10	30	16	$\frac{1}{4}$ to 1	5 65
14	17	$\frac{1}{4}$ to $\frac{3}{4}$	2 40	32	16	$\frac{1}{4}$ to 1	6 15
16	17	$\frac{1}{4}$ to $\frac{3}{8}$	2 75	34	16	$\frac{1}{4}$ to 1	6 65
18	17	$\frac{1}{4}$ to $\frac{3}{8}$	3 10	36	16	$\frac{1}{4}$ to 1	7 15
20	17	$\frac{1}{4}$ to $\frac{3}{4}$	3 45				

This list is for saws ground 3 gauges thin on back.

### STANDARD SIZES OF FELLOE WEBS IN STOCK.

6 and 7-inch.....  $\frac{1}{8}$  to  $\frac{3}{8}$  inches.      12-inch.....  $\frac{1}{8}$  to  $\frac{7}{8}$  inches.  
 8 and 10-inch.....  $\frac{1}{8}$  to  $\frac{3}{4}$  inches.      14 to 24-inch.....  $\frac{3}{8}$  to 1 inch.

$\frac{1}{8}$  and  $\frac{3}{8}$  widths, 8 points to the inch;  $\frac{1}{4}$ , 7 $\frac{1}{2}$  points;  $\frac{5}{8}$ , 7 points;  $\frac{3}{8}$ , 6 $\frac{1}{2}$  points;  $\frac{1}{2}$ , 6 points;  $\frac{5}{8}$ , 5 $\frac{1}{2}$  points;  $\frac{3}{4}$ , 5 points;  $\frac{7}{8}$ , 4 $\frac{1}{2}$  points; 1, 4 points.

Other than Standard Sizes will have to be manufactured special.  
 Special prices for all saws other than the above sizes.

N. B.—All Web Saws one-eighth inch and narrower will be made with wide ends in order to give strength at the hole, twenty-five per cent. advance; with pins, 50 cents per dozen additional, list.

## FAY'S PATENT SCROLL SAWS.



### Price List.

Inches.....	8	9	10	11	12	13	14	16	18	20	22	24
Per dozen...	\$2 00	2 25	2 50	2 75	3 00	3 25	3 50	3 75	4 00	4 50	5 00	5 50

Webs to 16 inches over three-fourths inch wide, extra price; eighteen to twenty-four inches, over one inch wide, extra price. We make the above Webs from 13 to 16 gauge in thickness; with pins, 50 cents per dozen additional, list.

## GERMAN PATTERN WEBS.

### Price List, Per Dozen.

Length, Inches.	$\frac{3}{8}$ to $\frac{1}{2}$ In. Wide.	$\frac{7}{8}$ to 1 $\frac{1}{2}$ In. Wide.	$\frac{1}{4}$ to 1 $\frac{1}{2}$ In. Wide.	1 $\frac{1}{2}$ to 2 In. Wide.	Length, Inches.	$\frac{3}{8}$ to $\frac{1}{2}$ In. Wide.	$\frac{7}{8}$ to 1 $\frac{1}{2}$ In. Wide.	1 $\frac{1}{4}$ to 1 $\frac{1}{2}$ In. Wide.	1 $\frac{1}{2}$ to 2 In. Wide.
18	\$2 55	\$2 65	\$2 75	\$2 85	28	\$3 35	\$3 50	\$3 65	\$3 75
20	2 65	2 75	2 85	2 95	30	3 60	3 75	3 95	4 05
22	2 75	2 85	2 95	3 05	32	3 85	4 00	4 25	4 35
24	2 90	3 00	3 10	3 25	34	4 10	4 25	4 55	4 65
26	3 10	3 25	3 35	3 45	36	4 35	4 50	4 85	4 95

### EXTRA THIN BACK.

18	\$3 20	\$3 30	\$3 40	\$3 50	28	\$4 10	\$4 20	\$4 35	\$4 50
20	3 30	3 40	3 50	3 60	30	4 40	4 50	4 70	4 85
22	3 40	3 50	3 60	3 70	32	4 70	4 80	5 05	5 20
24	3 55	3 65	3 80	3 90	34	5 00	5 10	5 40	5 55
26	3 80	3 90	4 05	4 20	36	5 30	5 40	5 75	5 90

All of above Webs are set and sharpened. Tanged Webs advance two inches on above.

# Atkins Improved Hack Saws

Our greatly improved methods and increased facilities for the manufacture of Hack Saws enables us to produce blades of superior excellence in enormous quantities. We are prepared to execute orders in any size and quantity without delay, and can guarantee our blades to give entire satisfaction. We use only the highest quality of steel, made especially to our order, and our patented process of manufacture and skillful workmanship insures a greater degree of efficiency than is possible to obtain from other saws.

Our Nos. 200, 205, 210 and 215 cover the line of "Hard" Hack Saw Blades.

Nos. 400, 410, 420, 430 and 440 cover the line of Power Hack Saw Blades.

We also make special blades for Coping Saw Frames, Nos. 500 and 510.

Our Hack Saws are sold under the "AAA" brand, and any blade so marked is covered by our warranty. Samples will be furnished free of charge.



## ATKINS "AAA" HACK SAW BLADES.



### BLADES FOR HAND FRAMES.

Atkins "all hard" blades have greater durability than any similar blade on the market, owing to the fact that we use a steel which is peculiarly adapted to this service. We have also perfected a process of tempering wherein we eliminate any variation in the consistency of the blades. The teeth are sharp, and are given just enough set to insure a free, smooth and rapid cut, removing no more stock than is necessary. A file will not touch them. It will be well to remember that these Hack Saws are as hard as files. This being the case, care should be taken not to bend them unnecessarily, for, like files, they will break easily and fly to pieces when bent.

No.	Length	Width	Thickness	Teeth per Inch	List per Gross	Weight per Gross
200.....	6 inches	½-inch	.025 or 23 gauge	18	\$7 00	3½ pounds
200.....	7 inches	½-inch	.025 or 23 gauge	18	7 50	4 pounds
200.....	8 inches	½-inch	.025 or 23 gauge	18	8 00	4½ pounds
200.....	9 inches	½-inch	.025 or 23 gauge	18	9 00	5¼ pounds
200.....	10 inches	½-inch	.025 or 23 gauge	18	10 00	5½ pounds
200.....	11 inches	½-inch	.025 or 23 gauge	18	11 00	6 pounds
200.....	12 inches	½-inch	.025 or 23 gauge	18	12 00	6½ pounds
205.....	12 inches	⅝-inch	.025 or 23 gauge	16	12 00	7¼ pounds
210.....	6 inches	½-inch	.025 or 23 gauge	24	7 00	3½ pounds
210.....	7 inches	½-inch	.025 or 23 gauge	24	7 50	4 pounds
210.....	8 inches	½-inch	.025 or 23 gauge	24	8 00	4½ pounds
210.....	9 inches	½-inch	.025 or 23 gauge	24	9 00	5¼ pounds
210.....	10 inches	½-inch	.025 or 23 gauge	24	10 00	5½ pounds
210.....	11 inches	½-inch	.025 or 23 gauge	24	11 00	6 pounds
210.....	12 inches	½-inch	.025 or 23 gauge	24	12 00	6½ pounds
215.....	6 inches	½-inch	.025 or 23 gauge	32	7 00	3½ pounds
215.....	7 inches	½-inch	.025 or 23 gauge	32	7 50	4 pounds
215.....	8 inches	½-inch	.025 or 23 gauge	32	8 00	4½ pounds
215.....	9 inches	½-inch	.025 or 23 gauge	32	9 00	5¼ pounds
215.....	10 inches	½-inch	.025 or 23 gauge	32	10 00	5½ pounds
215.....	11 inches	½-inch	.025 or 23 gauge	32	11 00	6 pounds
215.....	12 inches	½-inch	.025 or 23 gauge	32	12 00	6½ pounds
220.....	8 inches	½-inch	.028 or 22 gauge	14	9 00	4½ pounds
220.....	9 inches	½-inch	.028 or 22 gauge	14	9 60	5¼ pounds
220.....	10 inches	½-inch	.028 or 22 gauge	14	10 20	5½ pounds
220.....	11 inches	½-inch	.028 or 22 gauge	14	11 40	6 pounds
220.....	12 inches	½-inch	.028 or 22 gauge	14	12 60	7¼ pounds

Numbers 200, 205, 210, 215 and 220 are "all hard" blades.  
 Numbers 200, 205 and 220 for sawing solid steel, iron and bronze.  
 Number 210 for sawing solid brass, pipe and light work.  
 Number 215 for sawing thin tubing and light sheet metals.  
 All hand blades measure from hole to hole.

## ATKINS POWER HACK SAW BLADES. FOR ALL TYPES OF HACK SAW MACHINES.

Atkins power blades are all tempered hard, but by our special process the temper is graduated through the body so that just enough elasticity and life is imparted to the saw to make it far more serviceable than any other power saw on the market. They are especially adapted for use on our Kwick-Kut and all other makes of power machines.

## ATKINS POWER HACK SAW BLADES.

Continued.



### Blades for Light Gravity Feed Machines.

No	Length	Width	Thickness	Teeth per Inch	List per Gross	Weight per Gross
400.....	9 inches	$\frac{5}{8}$ -inch	.028 or 22 gauge	14	\$9 60	7 pounds
400.....	10 inches	$\frac{5}{8}$ -inch	.028 or 22 gauge	14	10 20	$7\frac{3}{4}$ pounds
400.....	11 inches	$\frac{5}{8}$ -inch	.028 or 22 gauge	14	11 40	$8\frac{1}{4}$ pounds
400.....	12 inches	$\frac{5}{8}$ -inch	.028 or 22 gauge	14	12 60	$9\frac{1}{2}$ pounds
400.....	14 inches	$\frac{5}{8}$ -inch	.028 or 22 gauge	14	15 00	10 $\frac{1}{2}$ pounds
400.....	17 inches	$\frac{5}{8}$ -inch	.028 or 22 gauge	14	22 20	13 pounds
400.....	18 inches	$\frac{5}{8}$ -inch	.028 or 22 gauge	14	24 00	$13\frac{3}{4}$ pounds
400.....	20 inches	$\frac{5}{8}$ -inch	.028 or 22 gauge	14	28 00	15 pounds

### Blades for Heavy Gravity Feed and Positive Feed.

409.....	12 inches	$\frac{3}{4}$ -inch	.032 or 21 gauge	18	\$15 00	12 pounds
409.....	14 inches	$\frac{3}{4}$ -inch	.032 or 21 gauge	18	18 00	14 pounds
410.....	12 inches	$\frac{3}{4}$ -inch	.032 or 21 gauge	14	15 00	12 pounds
410.....	14 inches	$\frac{3}{4}$ -inch	.032 or 21 gauge	14	18 00	14 pounds
410.....	17 inches	$\frac{3}{4}$ -inch	.032 or 21 gauge	14	22 20	$16\frac{1}{2}$ pounds
410.....	18 inches	$\frac{3}{4}$ -inch	.032 or 21 gauge	14	24 00	$17\frac{3}{4}$ pounds
410.....	20 inches	$\frac{3}{4}$ -inch	.032 or 21 gauge	14	28 00	$20\frac{1}{4}$ pounds
412.....	14 inches	1-inch	.032 or 21 gauge	10	24 00	16 pounds
412.....	17 inches	1-inch	.032 or 21 gauge	10	27 60	24 pounds
415.....	12 inches	$\frac{3}{4}$ -inch	.042 or 19 gauge	14	18 00	$16\frac{1}{4}$ pounds
415.....	14 inches	$\frac{3}{4}$ -inch	.042 or 19 gauge	14	21 00	$19\frac{1}{4}$ pounds
418.....	12 inches	$\frac{3}{4}$ -inch	.042 or 19 gauge	12	18 00	$16\frac{1}{4}$ pounds
418.....	14 inches	$\frac{3}{4}$ -inch	.042 or 19 gauge	12	21 00	$19\frac{1}{4}$ pounds
418.....	17 inches	$\frac{3}{4}$ -inch	.042 or 19 gauge	12	27 60	25 pounds
420.....	12 inches	$\frac{3}{4}$ -inch	.048 or 18 gauge	12	18 00	$18\frac{1}{2}$ pounds
420.....	14 inches	$\frac{3}{4}$ -inch	.048 or 18 gauge	12	21 60	$21\frac{1}{2}$ pounds
420.....	17 inches	$\frac{3}{4}$ -inch	.048 or 18 gauge	12	27 60	28 pounds
420.....	18 inches	$\frac{3}{4}$ -inch	.048 or 18 gauge	12	29 40	$29\frac{1}{2}$ pounds
422.....	12 inches	$\frac{3}{4}$ -inch	.048 or 18 gauge	10	18 00	$18\frac{1}{2}$ pounds
422.....	14 inches	$\frac{3}{4}$ -inch	.048 or 18 gauge	10	21 60	$21\frac{1}{2}$ pounds
422.....	17 inches	$\frac{3}{4}$ -inch	.048 or 18 gauge	10	27 60	28 pounds
425.....	12 inches	1-inch	.042 or 19 gauge	14	24 00	23 pounds
425.....	14 inches	1-inch	.042 or 19 gauge	14	27 00	25 pounds
425.....	17 inches	1-inch	.042 or 19 gauge	14	30 00	27 pounds
428.....	12 inches	1-inch	.042 or 19 gauge	10	24 00	23 pounds
428.....	14 inches	1-inch	.042 or 19 gauge	10	27 00	25 pounds
428.....	17 inches	1-inch	.042 or 19 gauge	10	30 00	27 pounds
430.....	12 inches	1-inch	.048 or 18 gauge	12	28 80	$24\frac{1}{2}$ pounds
430.....	14 inches	1-inch	.048 or 18 gauge	12	31 20	27 pounds
430.....	17 inches	1-inch	.048 or 18 gauge	12	36 00	33 pounds
430.....	18 inches	1-inch	.048 or 18 gauge	12	37 80	$34\frac{1}{2}$ pounds
430.....	20 inches	1-inch	.048 or 18 gauge	12	42 00	$38\frac{3}{4}$ pounds
430.....	24 inches	1-inch	.048 or 18 gauge	12	50 40	45 pounds



## ATKINS POWER HACK SAW BLADES.

Continued.

No.	Length	Width	Thickness	Teeth per Inch	List per Gross	Weight per Gross
435.....	12 inches	1-inch	.048 or 18 gauge	10	\$28 80	24½ pounds
435.....	14 inches	1-inch	.048 or 18 gauge	10	31 20	27 pounds
435.....	17 inches	1-inch	.048 or 18 gauge	10	36 00	33 pounds
440.....	14 inches	1-inch	.065 or 16 gauge	10	34 20	35½ pounds
440.....	17 inches	1-inch	.065 or 16 gauge	10	39 00	43 pounds
440.....	18 inches	1-inch	.065 or 16 gauge	10	40 80	48 pounds
440.....	20 inches	1-inch	.065 or 16 gauge	10	45 20	49½ pounds
440.....	24 inches	1-inch	.065 or 16 gauge	10	54 00	60 pounds

NOTE—12-inch blades measure from center to center of holes; 14-inch and over measure ½-inch less between center of holes than length given.

Eighteen teeth per inch can be furnished on Nos. 400, 410, 12 and 14-inch lengths only, when fine teeth are desired for sawing thin pipe, light work, etc.

For large stock, either iron or soft steel, use a coarse tooth blade; for large stock tool steel, use a medium tooth blade; for small stock tool steel, brass or bronze, use a medium or standard tooth blade; for pipe, use a medium or fine tooth blade, according to the thickness of the wall.

## ATKINS SCREW SLOTTING BLADES.

FOR HAND HACK SAW FRAMES.

Every Machine Shop has frequent occasion for cutting slots in screw heads, bolts, set screws and parts of machinery. Atkins Screw Slotting Blades are designed to perform this service easily, accurately and quickly. For convenience, we furnish the set in three thicknesses, viz: ⅛-inch, ⅜-inch and ½-inch. Blades are 8 inches long or for use in 8-inch Hand Hack Saw Frame, and are ground thin back.

The Blades are made of Special Steel, similar to that used in Atkins Circular Metal Cutting Saws. This steel is very hard, and the blades being ground thinner on the back and being toothed straight across without set, they are not apt to break easily.

No Machine Shop is complete without Atkins Screw Slotting Blades.

Packed three blades to the set in a wrapper.

List Price.....Per set, \$0 75

## ATKINS SPECIAL BLADES FOR COPING SAW FRAMES—JEWELERS' SAW.

**No. 500.** ¼-inch wide, .014-inch thick, 32 teeth to the inch.

Size, inches.....	5	6
Per gross.....	\$8 40	9 00

The 5-inch blade is made with straight ends only. The 6-inch blade with either holes or loop ends.

**No. 510.** Special Hack Saw Blade for light work. ¼-inch wide, .025-inch thick, 24 teeth to the inch.

Size, 6-inch only.....Per gross, \$9 00

This blade is made with either straight or bent ends. Both Nos. 500 and 510 are tempered hard throughout the entire blade by a new process, and drawn to a stiff spring.

## ATKINS HACK SAWS FOR SLATE.

We have perfected a special hack saw blade for cutting slate. These saws are hardened and toughened by our exclusive process.

**No. 405.** ⅝-inch wide, .028-inch thick, 14 teeth to the inch.

Size, inches.....	8	9	10	12
Per gross.....	\$9 00	10 20	11 40	12 60

## ATKIN'S IMPROVED "HOOSIER EXTENSION" HACK SAW.

**FINEST AND MOST SERVICEABLE FRAME MADE.**

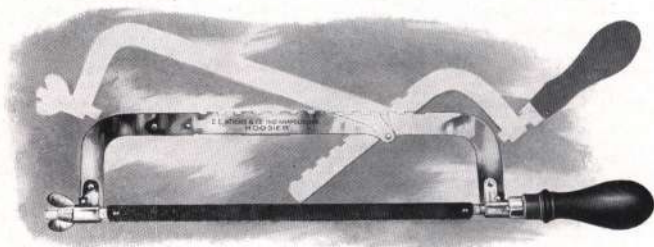

Made of high-grade steel; heavily nicked, highly polished. Takes in blade from 8 inches to 12 inches, inclusive. Blade is adjustable and can be faced four different ways. Fine enameled handle. Packed one in a box.

List price, with blades, per dozen, \$12.00.

## ATKINS INDIANA HACK SAWS.

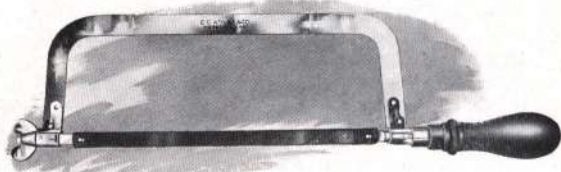

### "Indiana" Solid Steel, Adjustable.

Steel back, all nicked and polished. Blade is adjustable and can be faced four different ways. Enameled handle, fine finish.

List price, to hold 8-inch blade, complete with blade, per dozen, \$9.00.

Advance list 50 cents per inch per dozen for frames longer than 8 inches. Larger sizes to order. Packed one in a box.

## ATKINS 8-INCH IRON FRAME.



### The Best Hack Saw for the Money.

These frames are iron, black japanned, and have black wood handles. They are light in weight, graceful in appearance, but strong and rigid. The blade is held by stationary pins, which cannot be lost, and the blade can be faced four different ways. Packed ½-dozen in a box.

List price, to hold 8-inch blade, without blades, per dozen, \$4.20.



## ATKINS FLEXIBLE BACK METAL CUTTING BAND SAWS.

### IN COILS.

Width, Inches.	Thickness, Inches.	Feet per Pound.	Price per Pound.	Width, Inches.	Thickness, Inches.	Feet per Pound.	Price per Pound.
1/4	.025	60	\$7 00	5/8	.031	16	\$2 24
3/8	.025	35	3 50	3/4	.031	12	1 92
1/2	.025	25	2 50	1	.036	9	1 80

The above saws vary from 10 to 30 teeth to the inch. In ordering state class of work to be done.

### CUT TO LENGTH AND BRAZED.

Width, Inches.	Thickness, Inches.	Price per Foot.	Price for Brazing.	Width, Inches.	Thickness, Inches.	Price per Foot.	Price for Brazing.
1/4	.025	\$0 12	\$0 40	5/8	.031	\$0 14	\$0 40
3/8	.025	10	40	3/4	.031	16	50
1/2	.025	10	40	1	.036	20	50

The above saws made 10-12-14-15-18-22-24 and 30 teeth to the inch. Especially tempered to class of work they are to do.



No. 1	7 inches under back,	9-inch blades,	without blades	Per dozen,	\$15 00
No. 1 1/2	7	"	"	"	16 00
No. 2	10	"	"	"	18 00
No. 3	10	"	"	"	19 00
No. 4	10	"	"	"	23 00
No. 5	10	"	"	"	28 00
No. 6	10	"	"	"	33 00

### BLADES FOR ABOVE.

Inches	9	12	14	16	18	20
Per dozen	\$0 80	1 05	1 25	1 85	2 00	2 33

## PLUMBER'S SAWS.



Inches	12	14	16	18
List price	\$9 00	9 60	10 20	11 00

## Atkins Silver-Steel

The most essential feature of a Saw is the material used in the blade.

Cross-Cut Saw Steel must be hard, so as to prevent the teeth from bending or dulling easily and so they may hold their set. It must be tough so that it will withstand hard knots and obstructions. At the same time it must not be brittle, else the teeth will break off in use or in fitting.

That Steel which will measure up to these conditions to the highest degree is best adapted for Cross-Cut Saws.

### WHAT IT IS.

The formula of **Silver-Steel** is our own exclusive property and cannot be made public, but suffice it to say, it contains only the most effective and expensive ingredients. It is exceedingly close and smooth grained and while it will file easily, it will at the same time hold its keen cutting edge remarkably.

### OUR PROOF.

So carefully have we investigated the constituency of other Cross-Cut Saw Steel as compared with **Silver-Steel** and so thoroughly are we convinced of its merits that we absolutely guarantee that a **Silver-Steel Cross-Cut Saw** will hold its cutting edge one-fourth longer than any other.

### ATKINS SPECIAL STEEL.

This is a High-Grade Crucible steel fully equal to any other manufacturers best quality. For ordinary use, we recommend it in preference to any other brand. But where Saws are in constant use and the highest results are essential, we recommend our **Silver-Steel**.

### TEMPERING.

We use an exclusive process of Gas Tempering which automatically insures an absolutely uniform temper in all **Atkins Cross-Cut Saws**.

### HOW TO KNOW THEM.

Atkins Rex Nos. 1 and 2, Perfection Nos. 4 and 5, Peerless No. 3, Hemlock King No. 6, Rex Falling No. 11 and Perfection Falling No. 12 are made in **Silver-Steel only** and may be easily identified by noting the name, number and the words "**Silver-Steel**" on the blade. The balance of the line are made in both **Silver-Steel** and Special Steel and are so marked on the blade.

### WARNING.

Unprincipled merchants may endeavor to substitute Special Steel for **Silver-Steel**, or may tell you that the Special Steel is our Highest Grade. You may easily determine this fact for yourself by looking on the blade for the words "**Silver-Steel**" or "**Special Steel**" which denotes the quality of steel used in the blade.

**NOTE**—The process of Segment Grinding is described on the following page and explains why **Atkins Segment Ground Cross-Cut Saws** run easier and cut faster than any other.



## ATKINS SEGMENT GRINDING PROCESS.

We are the discoverers and sole users of the principle of segment grinding which has done more toward advancing the efficiency and speed of cross-cut saws than any other feature or features.

Segment Grinding consists of finishing the cross-cut saw blade of even gauge along the tooth edge and to a point about 1 inch above the gullets of the teeth, and from that point a TRUE TAPER to the back edge. They are not simply dubbed off on the back as some saws are. The blade is 2 gauges thinner on the back, on the ends and gradually tapers on the back toward the center, which is the thinnest point.

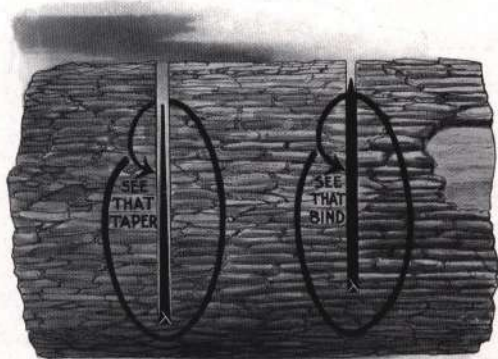

Atkins Segment Ground Cross-Cut Saws being thicker at the ends are stiff and do not buckle, and being thinner in the center of back, have ample clearance, enabling them to run fast and easy with very little set. The principle of Segment Grinding is best illustrated by the picture shown.

The manner in which our cross-cut teeth operate is illustrated very comprehensively below.

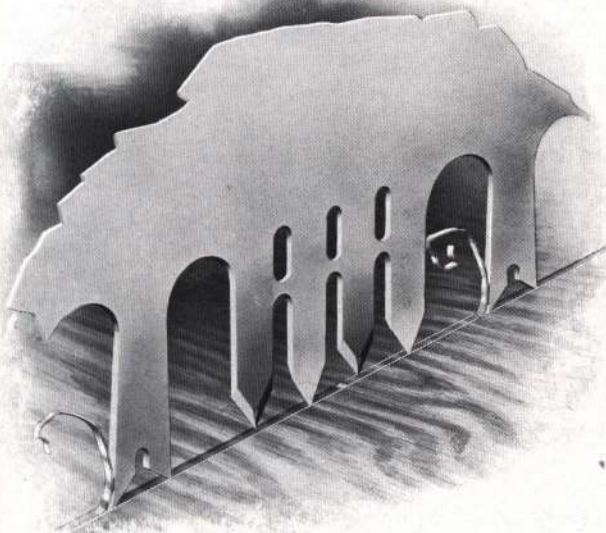

The cutting teeth being beveled on alternate sides and slightly longer than the rakers, cut the side of the kerf clean and true, leaving the rakers to clear the bottom. Atkins cross-cut saws produce shavings — not saw-dust.

The same principle applies to both two and four cutter teeth.

These illustrations demonstrate conclusively the reasons why Atkins cross-cut saws cut fast and easy.

**ATKINS STYLES OF CROSS-CUT TEETH.**

The following pages give a general conception of the large variety of teeth used in Atkins Cross-Cut Saws. Each pattern is designed so as to give the best results in different types of timber.

You will find not only styles similar to those you have been buying, but variations which would perhaps prove advantageous.

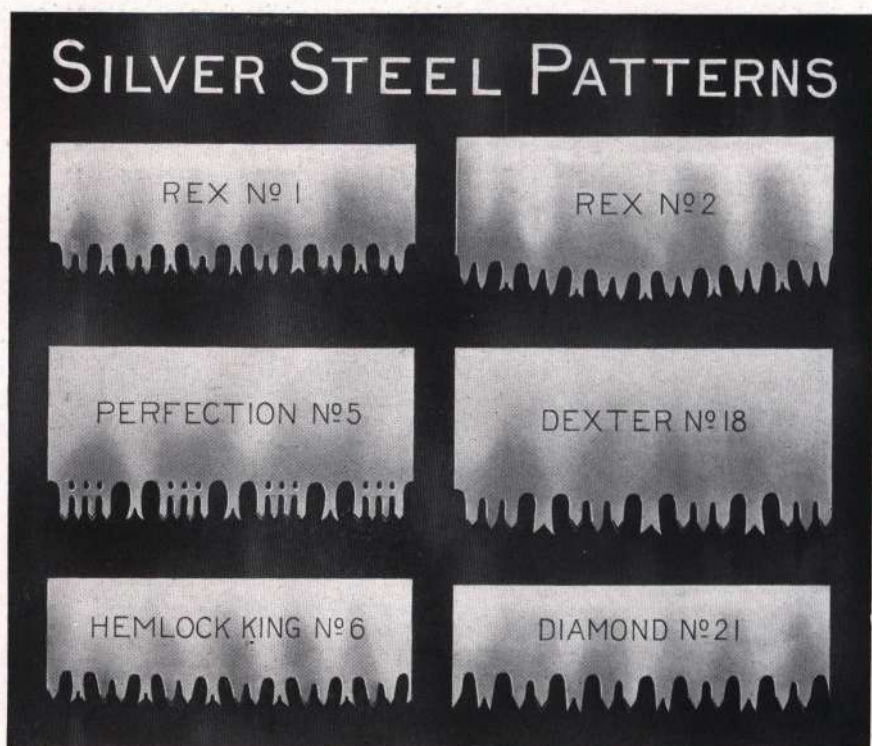



**STYLES OF TEETH  
USED IN ATKINS CROSS-CUT SAWS.**

**REGULAR PATTERNS**

DEXTER N°219



DIAMOND N°322



VICTOR N°325



LANCE N°327



IMPROVED UNIVERSAL  
N°316



TUTTLE N°330



ELECTRIC N°339



COMMON N°337



**HOLLOW BACK PATTERNS**

TUTTLE N°379



DIAMOND N°384



AMERICAN N°385



VICTOR N°386



**ATKINS SILVER-STEEL REX, No. 1.**

SEGMENT GROUND.

14 Gauge on Tooth Edge. 16 Gauge on Ends on Back Edge. 19 Gauge at Center on Back Edge.



**ATKINS SILVER-STEEL REX, No. 2.**

SEGMENT GROUND.

14 Gauge on Tooth Edge. 16 Gauge on Ends on Back Edge. 19 Gauge at Center on Back Edge.



List Price, Rex No. 1 and 2, Without Handles.

4 ft.	4 1/2 ft.	5 ft.	5 1/2 ft.	6 ft.	6 1/2 ft.	7 ft.	7 1/2 ft.	8 ft.
Silver-Steel.....\$3 10	3 60	4 10	4 80	5 60	6 40	7 30	8 30	9 30



# ATKINS SILVER-STEEL PERFECTION, No. 4.

## SEGMENT GROUND.

Same Style of Tooth as Perfection No. 5 but Narrower Blade.

14 Gauge on Tooth Edge. 19 Gauge at Center on Back. 16 Gauge on End on Back.



# ATKINS SILVER-STEEL PERFECTION, No. 5.

## SEGMENT GROUND.

They Will Out-Cut and Out-Wear Other Saws. Will Hold Their Cutting Edge in Hard Woods and Frozen Timber Where Other Saws Fail.



List Price, Perfection No. 4 and 5, Without Handles.

Silver-Steel.....	4 ft.	4 1/2 ft.	5 ft.	5 1/2 ft.	6 ft.	6 1/2 ft.	7 ft.	7 1/2 ft.	8 ft.
	3 60	4 10	4 80	5 60	6 40	7 30	8 30	9 30	

These Saws made in Silver-Steel only.

## ATKINS SEGMENT GROUND CROSS-CUT SAWS. FASTEST CUTTING and MOST POPULAR SAWS on the MARKET.

### ATKINS SILVER-STEEL PEERLESS, No. 3.

#### SEGMENT GROUND.

Same as No. 4 Rex. A Great Southern Favorite. Especially Adapted for Cutting  
All Classes of Timber Found in that Locality.

This Saw has been tried by timber cutters in all kinds of wood and pronounced the "best ever pulled." We guarantee satisfaction.  
Note carefully the narrow blade and the shape and style of teeth. A trial of this Saw will convince you of its superiority.

**14 Gauge on Tooth Edge.      19 Gauge at Center on Back.      16 Gauge on Ends on Back.**



### ATKINS SILVER-STEEL HEMLOCK KING, No. 6.

#### SEGMENT GROUND.

**14 Gauge on Tooth Edge.      19 Gauge at Center on Back.      16 Gauge on Ends on Back.**



**List Price, Peerless No. 3 and Hemlock King No. 6, Without Handles.**

Silver-Steel.....	4 ft.	4 ½ ft.	5 ft.	5 ½ ft.	6 ft.	6 ½ ft.	7 ft.	7 ½ ft.	8 ft.
	\$3 10	3 60	4 10	4 80	5 60	6 40	7 30	8 30	9 30

These Saws made in Silver-Steel only.



**ATKINS SILVER-STEEL REX FALLING, No. 11.**

NEW ENGLAND'S FAVORITES.

LIGHTEST AND FASTEST CUTTING SAWS MADE.

Patent Hollow Ground. Hand Fitted. Patent Gas Temper. Diamond Points. Swaged Rakers.



**ATKINS SILVER-STEEL PERFECTION FALLING, No. 12.**



List Price, Rex Falling No. 11 and Perfection Falling No. 12, Without Handles.

Silver-Steel.....	4 ft.	4 1/2 ft.	5 ft.	5 1/2 ft.	6 ft.	6 1/2 ft.	7 ft.	7 1/2 ft.	8 ft.
	\$3 10	3 60	4 10	4 80	5 60	6 40	7 30	8 30	9 30

These Saws made in Silver-Steel only.

## TEETH USED IN ATKINS MOSS-BACK CROSS-CUT SAWS.

We manufacture the Moss-Back Blade in any of the styles of teeth shown below. This permits of a broad range and supplies every possible requirement.

The evolution of the Cross-Cut Saw for the last four hundred years to the Columbian year. Embodying all the improvements in Cross-Cut Saws; practical uniformity of thickness of the toothed edge; thin-back; hollow-back; stiff ends; hand brought down to line of cut; perforated blade; diamond tooth and clearer, segment ground; high-grade of steel; hard and tough temper; perfection in manufacture and finish; each saw warranted perfect in every respect.

The pattern of the tooth preferred is shown in the cut, but we make the saw perforated or not, with Diamond, Dexter, Victor, Lance, Tuttle Tooth with Diamond Point. A trial of the saw will convince anyone of its merits.

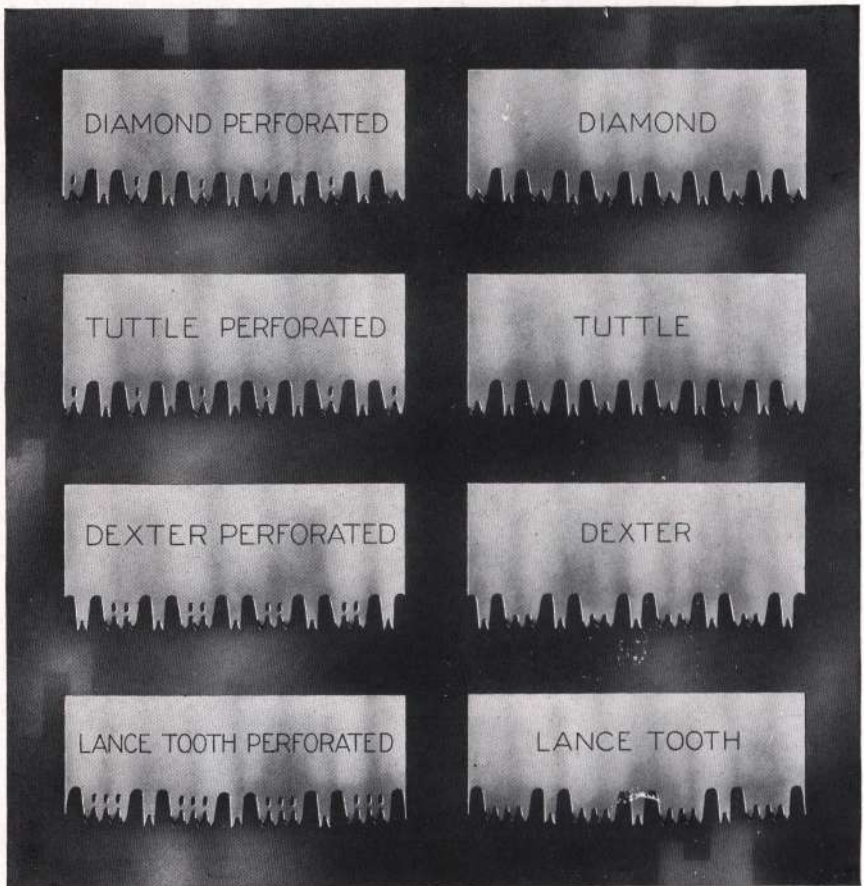



## ATKINS TRADE MARK MOSS-BACK CROSS-CUT SAWS. ATKINS LANCE TOOTH, PERFORATED, No. 278.



	4 ft.	4 1/2 ft.	5 ft.	5 1/2 ft.	6 ft.	6 1/2 ft.	7 ft.	7 1/2 ft.	8 ft.
No. 78 Silver-Steel.....	\$3 10	3 60	4 10	4 80	5 60	6 40	7 30	8 30	9 30
No. 278 Special Steel.....	2 80	3 15	3 50	3 85	4 20	4 55	4 90	5 25	5 60
<b>Atkins Moss-Back Lance Tooth, Not Perforated.</b>									
No. 77 Silver-Steel.....	\$3 10	3 60	4 10	4 80	5 60	6 40	7 30	8 30	9 30
No. 277 Special Steel.....	2 64	2 97	3 30	3 63	3 96	4 29	4 62	4 95	5 28
<b>Atkins Moss-Back Diamond, Not Perforated.</b>									
No. 70 Silver-Steel.....	\$3 10	3 60	4 10	4 80	5 60	6 40	7 30	8 30	9 30
No. 270 Special Steel.....	2 64	2 97	3 30	3 63	3 96	4 29	4 62	4 95	5 28
<b>Atkins Moss-Back Diamond, Perforated.</b>									
No. 71 Silver-Steel.....	\$3 10	3 60	4 10	4 80	5 60	6 40	7 30	8 30	9 30
No. 271 Special Steel.....	2 80	3 15	3 50	3 85	4 20	4 55	4 90	5 25	5 60
<b>Atkins Moss-Back Tuttle, Not Perforated.</b>									
No. 72 Silver-Steel.....	\$3 10	3 60	4 10	4 80	5 60	6 40	7 30	8 30	9 30
No. 272 Special Steel.....	2 64	2 97	3 30	3 63	3 96	4 29	4 62	4 95	5 28
<b>Atkins Moss-Back Tuttle, Perforated.</b>									
No. 73 Silver-Steel.....	\$3 10	3 60	4 10	4 80	5 60	6 40	7 30	8 30	9 30
No. 273 Special Steel.....	2 80	3 15	3 50	3 85	4 20	4 55	4 90	5 25	5 60
<b>Atkins Moss-Back Dexter, Not Perforated.</b>									
No. 74 Silver-Steel.....	\$3 10	3 60	4 10	4 80	5 60	6 40	7 30	8 30	9 30
No. 274 Special Steel.....	3 10	3 60	4 00	4 40	4 80	5 20	5 60	6 00	6 40
<b>Atkins Moss-Back Dexter, Perforated.</b>									
No. 75 Silver-Steel.....	\$3 10	3 60	4 10	4 80	5 60	6 40	7 30	8 30	9 30
No. 275 Special Steel.....	3 10	3 60	4 00	4 40	4 80	5 20	5 60	6 00	6 40
<b>Atkins Moss-Back Concave Tooth Dexter.</b>									
No. 76 Silver-Steel.....	\$3 10	3 60	4 10	4 80	5 60	6 40	7 30	8 30	9 30
No. 276 Special Steel.....	3 10	3 60	4 00	4 40	4 80	5 20	5 60	6 00	6 40

All above 14x18 gauge.

**ATKINS IMPROVED UNIVERSAL, No. 316.**



The teeth are arranged so simple that there is no trouble to keep them in order. The points of the teeth in these saws are of the same arrangement as in the Improved Universal Hand Saws. They are guaranteed to work satisfactorily in soft or hard wood. They have a decided advantage over other saws in rough timber where knots can not be avoided.

**List Prices, Improved Universal, No. 316, Without Handles.**

	4 ft.	4 1/2 ft.	5 ft.	5 1/2 ft.	6 ft.	6 1/2 ft.	7 ft.	7 1/2 ft.	8 ft.
No. 316	14x18 gauge.....	\$3 00	3 38	3 75	4 13	4 50	4 88	5 25	5 63
No. 710	14x19 gauge, segment ground	3 28	3 84	4 45	5 11	5 82	6 48	7 24	8 00

**List Prices, Matchless, No. 317, Without Handles.**

	4 ft.	4 1/2 ft.	5 ft.	5 1/2 ft.	6 ft.	6 1/2 ft.	7 ft.	7 1/2 ft.	8 ft.
No. 317	14x18 gauge.....	\$3 00	3 38	3 75	4 13	4 50	4 88	5 25	5 63
No. 709	14x19 gauge, segment ground	3 28	3 84	4 45	5 11	5 82	6 48	7 24	8 00

**ATKINS HOLLOW-BACK MATCHLESS, No. 382.**

This Style of Tooth is also made in Wide Blade, see No. 317 listed above.



**List Price, Hollow-Back Matchless, No. 382, Without Handles.**

	4 ft.	4 1/2 ft.	5 ft.	5 1/2 ft.	6 ft.	6 1/2 ft.	7 ft.	7 1/2 ft.	8 ft.
No. 382	.....	\$1 64	1 85	2 05	2 26	2 46	2 67	2 87	3 08

**ATKINS HOLLOW-BACK IMPROVED UNIVERSAL, No. 383.**

Same Blade as No. 382 with same Tooth as No. 316.

**List Price, Without Handles.**

	4 ft.	4 1/2 ft.	5 ft.	5 1/2 ft.	6 ft.	6 1/2 ft.	7 ft.	7 1/2 ft.	8 ft.
No. 383	.....	\$1 64	1 85	2 05	2 26	2 46	2 67	2 87	3 08



**ATKINS CONCAVE TOOTH DEXTER.**

TRADE  
MARK

**Dixie's Favorite. For the Woods of the South It Has No Equal. Stands at the Head of the List of Easy, Fast Cutting Saws.**

**MADE IN EITHER SILVER-STEEL OR SPECIAL STEEL.**

Notwithstanding the inferior imitations of this saw placed on the market by other manufacturers, under various names, our GENUINE DEXTER has held the market, and today leads all other makes of this pattern of saw. We recommend buyers and users to refuse all imitations, and when buying Cross-Cut Saws having three cutting teeth between each set of cleaning teeth, to buy and use only those saws which have our brand, "E. C. Atkins & Co.," and trade-mark word Dexter and the picture of a horse plainly etched upon the saw.

NOTE.—All Cross-Cut Saws having three cutting teeth between two sets of rakers are imitations or infringements, except those having the brand "E. C. Atkins & Co.," and the trade-mark word Dexter and the picture of a horse.



**List Prices, Without Handles.**

	4 ft.	4 1/2 ft.	5 ft.	5 1/2 ft.	6 ft.	6 1/2 ft.	7 ft.	7 1/2 ft.	8 ft.
No. 18 Silver-Steel, 14x16 gauge									
No. 19 Silver-Steel, 14x18 gauge	\$3 10	3 60	4 10	4 80	5 60	6 40	7 30	8 30	9 30
No. 20 Silver-Steel, 14x19 gauge									
No. 218 Special Steel, 14x16 gauge ..	3 04	3 42	3 80	4 18	4 56	4 94	5 32	5 70	6 08
No. 219 Special Steel, 14x18 gauge	3 20	3 60	4 00	4 40	4 80	5 20	5 60	6 00	6 40
No. 220 Special Steel, 14x19 gauge									

No. 219 Thin-Back, No. 220 Extra Thin-Back.

## ATKINS REGULAR PATTERN CROSS-CUT SAWS.

### ATKINS DIAMOND, No. 222.



**List Prices, Without Handles.**

No. 21 Silver-Steel, 14x16 gauge	4 ft.	4½ ft.	5 ft.	5½ ft.	6 ft.	6½ ft.	7 ft.	7½ ft.	8 ft.
No. 22 Silver-Steel, 14x18 gauge	} \$3 10	3 60	4 10	4 80	5 60	6 40	7 30	8 30	9 30
No. 221 Special Steel, 14x16 gauge		2 52	2 80	3 08	3 36	3 64	3 92	4 20	4 48
No. 222 Special Steel, 14x18 gauge	2 40	2 70	3 00	3 30	3 60	3 90	4 20	4 50	4 80

### ATKINS LONE STAR, No. 223.

**DIAMOND TOOTH.**

Six-foot Blade, 5¼ inches wide at center.

Seven-foot Blade, 6 inches wide at center.



**List Price, Without Handles.**

No. 223 Special Steel, 14x18 gauge	4 ft.	4½ ft.	5 ft.	5½ ft.	6 ft.	6½ ft.	7 ft.	7½ ft.	8 ft.
	\$2 40	2 70	3 00	3 30	3 60	3 90	4 20	4 50	4 80

We furnish any of the above Saws in Silver-Steel.



**CANADA'S FAVORITE, "THE VICTOR," No. 225.**

**PERFORATED TOOTH.**

Patented February 12, 1884.



**List Price, Victor, Without Handles.**

4 ft.	4 1/2 ft.	5 ft.	5 1/2 ft.	6 ft.	6 1/2 ft.	7 ft.	7 1/2 ft.	8 ft.
No. 225 Special Steel, 14x18 gauge ..\$2 56	2 88	3 20	3 52	3 84	4 16	4 48	4 80	5 12

**ATKINS LANCE TOOTH, No. 227.**

**THIN-BACK, NOT PERFORATED.**



**List Price, Lance, Without Handles.**

4 ft.	4 1/2 ft.	5 ft.	5 1/2 ft.	6 ft.	6 1/2 ft.	7 ft.	7 1/2 ft.	8 ft.
No. 227 Special Steel, 14x18 gauge ..\$2 40	2 70	3 00	3 30	3 60	3 90	4 20	4 50	4 80

We can furnish either of the above Saws in Silver-Steel. Regular Gauge is 14x16. Thin-Back is 14x18 Gauge.

## ATKINS REGULAR PATTERN CROSS-CUT SAWS.

### "OUR THIN-BACK" TUTTLE TOOTH, No. 331. TRADE DIAMOND POINT. MARK. ORIGINAL TUTTLE TOOTH.

The Best Saw in the World for the Money.



#### List Prices, Without Handles.

	4 ft.	4½ ft.	5 ft.	5½ ft.	6 ft.	6½ ft.	7 ft.	7½ ft.	8 ft.
No. 330 Special Steel, 14x16 gauge ..	\$1 92	2 16	2 40	2 64	2 88	3 12	3 36	3 60	3 84
No. 331 Special Steel, 14x18 gauge ..	2 08	2 34	2 60	2 86	3 12	3 38	3 64	3 90	4 16
No. 332 Special Steel, 14x19 gauge ..	2 58	2 84	3 10	3 36	3 62	3 88	4 15	4 40	4 66

### ELECTRIC TOOTH, No. 339.



#### List Prices, Without Handles.

	4 ft.	4½ ft.	5 ft.	5½ ft.	6 ft.	6½ ft.	7 ft.	7½ ft.	8 ft.
No. 339 Special Steel, 14x16 gauge ..	\$2 24	2 52	2 80	3 08	3 36	3 64	3 92	4 20	4 48
No. 340 Special Steel, 14x18 gauge ..	2 40	2 70	3 00	3 30	3 60	3 90	4 20	4 50	4 80

We can furnish either of the above Saws in Silver-Steel. Regular Gauge is 14x16. Thin-Back is 14x18 Gauge.



**ATKINS  
REGULAR PATTERN CROSS-CUT SAWS.**

**THE AMERICAN TOOTH, No. 333.**



**List Prices, Without Handles.**

No. 333	Special Steel, 14x16 gauge..	\$2 24	4 ft.	4 1/2 ft.	5 ft.	5 1/2 ft.	6 ft.	6 1/2 ft.	7 ft.	7 1/2 ft.	8 ft.
No. 334	Special Steel, 14x18 gauge..	2 40	2 70	3 00	3 08	3 30	3 36	3 90	4 20	4 50	4 80

**COMMON TOOTH, No. 337.**



**List Prices, Without Handles.**

No. 337	Special Steel, 14x16 gauge..	\$1 92	4 ft.	4 1/2 ft.	5 ft.	5 1/2 ft.	6 ft.	6 1/2 ft.	7 ft.	7 1/2 ft.	8 ft.
No. 338	Special Steel, 14x18 gauge..	2 08	2 34	2 60	2 86	3 12	3 12	3 38	3 64	3 90	4 16

**HICKORY, No. 335.**

**List Price, Without Handles.**

No. 335	Special Steel, 14x16 gauge..	\$1 92	4 ft.	4 1/2 ft.	5 ft.	5 1/2 ft.	6 ft.	6 1/2 ft.	7 ft.	7 1/2 ft.	8 ft.
			2 16	2 40	2 64	2 88	3 12	3 36	3 60	3 84	4 16

**ATKINS FEATHER EDGE, THIN-BACK, No. 336.**

Same as Hickory only 14x18 Gauge.

**List Price, Without Handles.**

No. 336	Special Steel, 14x18 gauge..	\$2 08	4 ft.	4 1/2 ft.	5 ft.	5 1/2 ft.	6 ft.	6 1/2 ft.	7 ft.	7 1/2 ft.	8 ft.
			2 34	2 60	2 86	3 12	3 38	3 64	3 90	4 16	4 48

We can furnish any of the above Saws in Silver-Steel. Regular Gauge is 14x16. Thin-Back is 14x18 Gauge.

## ATKINS HOLLOW-BACK TUTTLE, No. 379.

HIGH-GRADE, SPECIAL STEEL.



**List Prices, Without Handles.**

No. 379	3¼ inches wide	4 ft.	4½ ft.	5 ft.	5½ ft.	6 ft.	6½ ft.	7 ft.	7½ ft.	8 ft.
		.....\$1 04	1 17	1 30	1 43	1 56	1 69	1 82	1 95	2 08
No. 380	3¾ inches wide, 13 or 14 gauge	1 20	1 35	1 50	1 65	1 80	1 95	2 10	2 25	2 40
No. 381	3¾ in. wide 14x16 or 13x15 ga.	1 46	1 63	1 80	1 97	2 14	2 31	2 48	2 65	2 82

## ATKINS HOLLOW-BACK DIAMOND, No. 384.

A VERY FINE AND POPULAR SAW.



**List Price, Without Handles.**

No. 384	3¼ inches wide	4 ft.	4¼ ft.	5 ft.	5½ ft.	6 ft.	6½ ft.	7 ft.	7½ ft.	8 ft.
		.....\$1 20	1 35	1 50	1 65	1 80	1 95	2 10	2 25	2 40



**ATKINS HOLLOW-BACK AMERICAN TOOTH, No. 385.**



**List Price, Without Handles.**

No. 385	3 1/4 inches wide.....	\$1 20	4 ft.	1 35	5 ft.	1 50	5 1/2 ft.	1 65	6 ft.	1 80	6 1/2 ft.	1 95	7 ft.	2 10	7 1/2 ft.	2 25	8 ft.	2 40
---------	------------------------	--------	-------	------	-------	------	-----------	------	-------	------	-----------	------	-------	------	-----------	------	-------	------

**ATKINS HOLLOW-BACK VICTOR, No. 386.**

LANCE TOOTH PATTERN.



**List Prices, Without Handles.**

No. 386	3 1/4 inches wide.....	\$1 28	4 ft.	1 44	5 ft.	1 60	5 1/2 ft.	1 76	6 ft.	1 92	6 1/2 ft.	2 08	7 ft.	2 24	7 1/2 ft.	2 40	8 ft.	2 56
No. 387	3 1/4 inches wide, 14 gauge....	1 44	4 ft.	1 62	5 ft.	1 80	5 1/2 ft.	1 98	6 ft.	2 16	6 1/2 ft.	2 34	7 ft.	2 52	7 1/2 ft.	2 70	8 ft.	2 88
No. 388	3 3/4 inches wide, 14x16 gauge	1 60	4 ft.	1 80	5 ft.	2 00	5 1/2 ft.	2 20	6 ft.	2 40	6 1/2 ft.	2 60	7 ft.	2 80	7 1/2 ft.	3 00	8 ft.	3 20

## ATKINS ONE-MAN CROSS-CUT SAWS.

### THE CEDAR KING, No. 389.

This is the Finest One-Man Cross-Cut Saw made. The Blade is of very fine Special Crucible Steel. It will receive a sharp, keen cutting edge and retain it for a remarkable length of time. It is made and ground on the same principle as our High-Grade Hand Saws. The tooth edge is of even thickness but the blade gradually tapers to the point on the back, which is the thinnest part. This gives the blade clearance and permits the Saw to run easy and cut fast with but little set.

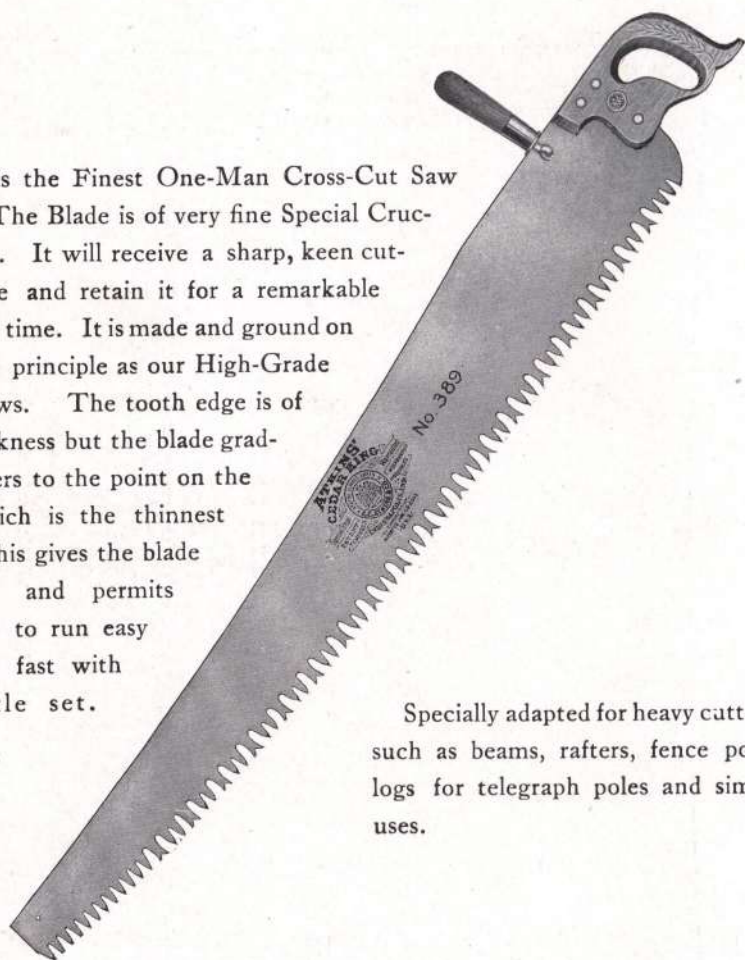

Specially adapted for heavy cutting, such as beams, rafters, fence posts, logs for telegraph poles and similar uses.

Skew-Back, Rex Pattern Teeth, Swaged Raker Teeth, Carved Handle, Easy Grip Pattern, Varnished Edge. Three Brass Screws and Medallion.

**List Price.**

	3 ft.	3½ ft.	4 ft.	4½ ft.	5 ft.	5½ ft.	6 ft.
No. 389 Special Steel.....	\$2 10	2 45	2 80	3 15	3 50	3 85	4 20



## ATKINS ONE-MAN CROSS-CUT SAWS. TUTTLE TOOTH, No. 390.



	3 ft.	3½ ft.	4 ft.	4½ ft.	5 ft.	5½ ft.	6 ft.
No. 390 Special Steel.....	\$1 68	1 96	2 24	2 52	2 80	3 08	3 36

## DIAMOND TOOTH, No. 391.



	3 ft.	3½ ft.	4 ft.	4½ ft.	5 ft.	5½ ft.	6 ft.
No. 391 Special Steel.....	\$1 80	2 10	2 40	2 70	3 00	3 30	3 60

## VICTOR TOOTH, No. 392.



	3 ft.	3½ ft.	4 ft.	4½ ft.	5 ft.	5½ ft.	6 ft.
No. 392 Special Steel.....	\$1 92	2 24	2 56	2 88	3 20	3 52	3 84
No. 394 Special Steel, Skew-back	2 04	2 38	2 72	3 06	3 40	3 74	4 08

## ATKINS ONE-MAN CROSS-CUT SAWS.

### THE AMERICAN TOOTH, No. 393.



	3 ft.	3½ ft.	4 ft.	4½ ft.	5 ft.	5½ ft.	6 ft.
No. 393 Special Steel.....	\$1 80	2 10	2 40	2 70	3 00	3 30	3 60

### AMERICAN TOOTH SKEW-BACK, No. 395.



	3 ft.	3½ ft.	4 ft.	4½ ft.	5 ft.	5½ ft.	6 ft.
No. 395 Special Steel.....	\$1 92	2 24	2 56	2 88	3 20	3 52	3 84

## SILVER-STEEL ONE-MAN SAWS.

For those desiring an unusually High Grade One-Man Saw, we wish to call your attention especially to our Silver-Steel line. We are able to supply any of the One-Man Saws here shown, in Silver-Steel instead of Special Steel, and in order to introduce them thoroughly, have placed them at a much reduced list. This is only a trifling advance over the Special Steel price, and the saws will be found much superior.

#### Silver Steel, List Price,

	3 ft.	3½ ft.	4 ft.	4½ ft.	5 ft.	5½ ft.	6 ft.
Any pattern or style of tooth.....	\$3 00	3 50	4 00	4 50	5 00	5 50	6 00



## Cross-Cut Saws for the Pacific Coast

For many years we have been making a specialty of Cross-Cut Saws for use on the Pacific Coast, and we defy competition to produce saws that are as perfect as those bearing our name.

We make several patterns suitable for different localities and the peculiar nature of the various timbers—these patterns being the result of years of constant study to please the users with saws that will cut rapidly and run with ease. Our vast growing trade on this line of saws on the Coast is sufficient evidence of the superiority of our goods.

We respectfully solicit trade on these saws, either direct or through our several jobbing agencies, located in all the principal cities of the Coast. We carry a full line at our Pacific Coast Branches, at Portland, Oregon; San Francisco, California, and Seattle, Washington, where orders may be sent for prompt execution.

We call attention to some of our leading patterns of teeth:

**Occident,  
Dexter,  
Star of the West,  
Pacific Star,  
Diamond,**

**Eureka,  
Pacifico,  
Lance,  
Perfection,  
Worden,**

**Tyee,  
Howatson,  
Clincher,  
Redwood King,  
Eureka Falling.**

**STYLES OF TEETH  
ATKINS CROSS-CUT SAWS  
FOR  
PACIFIC COAST.**

We manufacture a special line of Cross-Cut Saws for use on the Pacific Coast. They are admirably adapted to the needs of this territory, made in extra long lengths, toothed to the end and will be found "The Finest on Earth."

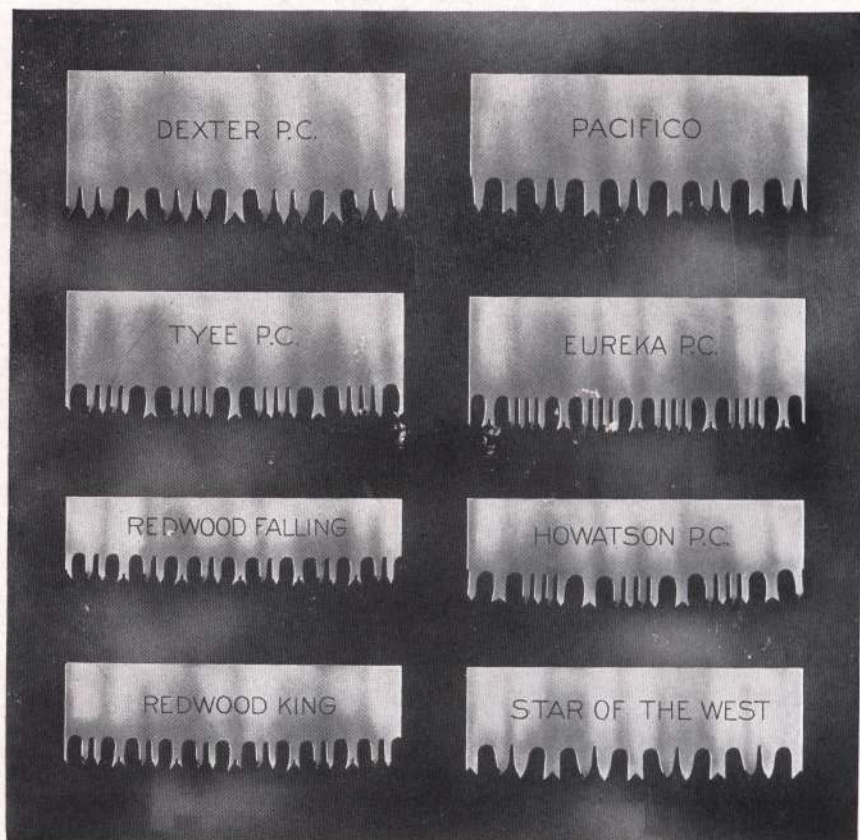





ATKINS  
PACIFIC COAST PATTERNS.

ATKINS REDWOOD KING, No. 64.

This Saw is Especially Adapted for "Bucking" and is the Most Satisfactory Ever Put on the Market for the Purpose.



4 1/8 inches wide at each end. 7 inches wide at center, with 1/4-inch bow on back.

List Price, No. 64, Silver-Steel, Standard Gauge, Without Handles.

4 ft.	4 1/2 ft.	5 ft.	5 1/2 ft.	6 ft.	6 1/2 ft.	7 ft.	7 1/2 ft.	8 ft.	8 1/2 ft.	9 ft.	9 1/2 ft.	10 ft.	11 ft.	12 ft.	14 ft.	16 ft.	18 ft.	20 ft.	
\$4.80	5.40	6.00	6.60	7.20	7.80	8.40	9.00	9.60	10.20	10.80	11.40	12.00	12.60	13.20	13.80	14.40	15.00	15.60	16.20

List Price, 11 Gauge, Without Handles.

4 ft.	4 1/2 ft.	5 ft.	5 1/2 ft.	6 ft.	6 1/2 ft.	7 ft.	7 1/2 ft.	8 ft.	8 1/2 ft.	9 ft.	9 1/2 ft.	10 ft.	11 ft.	12 ft.	14 ft.	16 ft.	18 ft.	20 ft.	
\$4.96	5.58	6.20	6.82	7.44	8.06	8.68	9.30	9.92	10.54	11.16	11.78	12.40	13.02	13.64	14.26	14.88	15.50	16.12	16.74

List Price, No. 65, Silver-Steel, 10 Gauge, Without Handles.

4 ft.	4 1/2 ft.	5 ft.	5 1/2 ft.	6 ft.	6 1/2 ft.	7 ft.	7 1/2 ft.	8 ft.	8 1/2 ft.	9 ft.	9 1/2 ft.	10 ft.	11 ft.	12 ft.	14 ft.	16 ft.	18 ft.	20 ft.	
\$5.04	5.67	6.30	6.93	7.56	8.19	8.82	9.45	10.08	10.71	11.34	11.97	12.60	13.23	13.86	14.49	15.12	15.75	16.38	17.01

List Price, No. 66, Silver-Steel, 9 Gauge, Without Handles.

4 ft.	4 1/2 ft.	5 ft.	5 1/2 ft.	6 ft.	6 1/2 ft.	7 ft.	7 1/2 ft.	8 ft.	8 1/2 ft.	9 ft.	9 1/2 ft.	10 ft.	11 ft.	12 ft.	14 ft.	16 ft.	18 ft.	20 ft.	
\$5.28	5.94	6.60	7.26	7.92	8.58	9.24	9.90	10.56	11.22	11.88	12.54	13.20	13.86	14.52	15.18	15.84	16.50	17.16	17.82

REDWOOD FALLING SAW, No. 67.



List Price, Without Handles.

6 ft.	6 1/2 ft.	7 ft.	7 1/2 ft.	8 ft.	8 1/2 ft.	9 ft.	9 1/2 ft.	10 ft.	11 ft.	12 ft.	14 ft.	16 ft.	18 ft.	20 ft.						
\$7.20	7.80	8.40	9.00	9.60	10.20	10.80	11.40	12.00	12.60	13.20	13.80	14.40	15.00	15.60	16.20	16.80	17.40	18.00	18.60	19.20



## THE EUREKA, No. 68.

This is a new Saw, but has been popular from the start. It has a long tooth similar to the Tyece, and is a very rapid and easy cutter. Especially adapted for California trade.



**List Price, Without Handles.**

No. 68 Silver-Steel.....	6 ft.	7 ft.	7 ½ ft.	8 ft.	8 ½ ft.	9 ft.	9 ½ ft.
	\$ 7 20	8 40	9 00	9 60	12 00	13 10	14 25
	10 ft.	12 ft.	14 ft.	16 ft.	18 ft.	20 ft.	
No. 68 Silver-Steel.....	\$15 50	22 00	26 00	30 00	34 00	40 00	

## THE EUREKA FALLING SAW, No. 69.

This Saw has the same teeth as the Eureka No. 68, but is furnished with a Falling Blade as shown in illustration. We can heartily recommend it for this purpose. Very popular and much used throughout California.



**List Price, Without Handles.**

No. 69 Silver-Steel.....	6 ft.	7 ft.	7 ½ ft.	8 ft.	8 ½ ft.	9 ft.	9 ½ ft.
	\$ 7 20	8 40	9 00	9 60	12 00	13 10	14 25
	10 ft.	12 ft.	14 ft.	16 ft.	18 ft.	20 ft.	
No. 69 Silver-Steel.....	\$15 50	22 00	26 00	30 00	34 00	40 00	

**THE PERFECTION, No. 55.**

Ground by our Patented Segment Process, which is Exclusively Controlled by Us.



**List Price, Without Handles.**

No. 55	4 ft.	4 1/2 ft.	5 ft.	5 1/2 ft.	6 ft.	6 1/2 ft.	7 ft.	7 1/2 ft.	8 ft.
	14x18 ga.	3 60	4 10	4 80	5 60	6 40	7 30	8 30	9 30

**ATKINS CELEBRATED DEXTER, No. 259.**

**SPECIAL PACIFIC COAST PATTERNS.**

The patent by which this Saw is protected consists of a depression of the face of the cutting teeth through the center from point to base, thus removing all friction while in use, giving strength and stiffness to the teeth, and increasing threefold the durability of the "set." This Saw never fails to give the best of satisfaction.



**List Prices, Without Handles.**

No. 259	4 ft.	4 1/2 ft.	5 ft.	5 1/2 ft.	6 ft.	6 1/2 ft.	7 ft.	7 1/2 ft.	8 ft.
	Special Steel, 14x18 gauge	3 60	4 00	4 40	4 80	5 20	5 60	6 00	6 40
No. 605	Special Steel, 13x17 gauge	3 20	4 00	4 45	5 00	5 65	6 30	6 95	7 60

We furnish the above Saw in Silver-Steel. Prices on application.



**ATKINS  
PACIFIC COAST PATTERNS.**

**STAR OF THE WEST, No. 257.**

**THE LATEST PATTERN SAW FOR FELLING TIMBER.**

There is a large and growing demand for a good Saw for felling timber. We have met this demand in the introduction of our Star of the West, a Saw that is at once narrow and stiff. Can be used in small timber without bending, and will stand crowding and not buckle.

**Ground by our Patented Segment Process, which is Exclusively Controlled by Us.  
The Most Improved Design Extant. High-Grade Steel. Fully Warranted.  
Perfectly Fitted for Use. Made for Experts.**

Width of 7-foot blade at center, 5¼ inches. Width of 8½-foot blade at center, 6 inches.



**PACIFIC STAR, No. 258.**



**List Prices, Star of the West and Pacific Star, Without Handles.**

No. 257	Special Steel, 12x17 gauge	4 ft.	4¼ ft.	5 ft.	5½ ft.	6 ft.	6½ ft.	7 ft.	7½ ft.	8 ft.
No. 258	Special Steel, 12x17 gauge	4 00	4 50	5 00	5 50	6 00	6 50	7 00	7 50	8 00

We furnish either of the above Saws in Silver-Steel. Prices on application.

**CROSS-CUT SAWS TOOTHED TO END OF BLADE.**

**TRADE VICTOR, No. 360. MARK**  
**LANCE TOOTH, PERFORATED.**

		List Price, THIN-BACK, Without Handles.					
		4 ft.	4½ ft.	5 ft.	5½ ft.	6 ft.	6½ ft.
No. 360	Special Steel, 14x18 gauge ..	\$2 56	2 88	3 20	3 52	3 84	4 16
No. 703	Special Steel, 13x17 gauge ..	2 88	3 24	3 60	3 96	4 32	4 68
						7 ft.	7½ ft.
						4 48	4 80
						5 04	5 40
							8 ft.
							5 12
							5 76

**LANCE TOOTH, No. 361.**

**NOT PERFORATED.**

		List Price, THIN-BACK, Without Handles.					
		4 ft.	4½ ft.	5 ft.	5½ ft.	6 ft.	6½ ft.
No. 361	Special Steel, 14x18 gauge ..	\$2 56	2 88	3 20	3 52	3 84	4 16
No. 704	Special Steel, 13x17 gauge ..	2 88	3 24	3 60	3 96	4 32	4 68
						7 ft.	7½ ft.
						4 48	4 80
						5 04	5 40
							8 ft.
							5 12
							5 76

We furnish either of the above Saws in Silver-Steel. Prices on application.



**ATKINS DIAMOND, No. 362.**

WELL KNOWN WHEREVER SAWS ARE USED.



**List Prices, Diamond Thin-Back, Without Handles.**

	4 ft.	4½ ft.	5 ft.	5½ ft.	6 ft.	6½ ft.	7 ft.	7½ ft.	8 ft.
No. 362 Special Steel, 14x18 gauge ..	\$2 40	2 70	3 00	3 30	3 60	3 90	4 20	4 50	4 80
No. 706 Special Steel, 13x17 gauge ..	2 80	3 15	3 50	3 85	4 20	4 55	4 90	5 25	5 60

**ATKINS TUTTLE TOOTH, No. 263.**

TRADE DIAMOND POINT. MARK

**ORIGINAL TUTTLE TOOTH.**

The Best Saw in the World for the Money.



**List Prices, Tuttle Tooth Thin-Back, Without Handles.**

	4 ft.	4½ ft.	5 ft.	5½ ft.	6 ft.	6½ ft.	7 ft.	7½ ft.	8 ft.
No. 263 Special Steel, 14x18 gauge ..	\$2 40	2 70	3 00	3 30	3 60	3 90	4 20	4 50	4 80
No. 708 Special Steel, 13x17 gauge ..	2 80	3 15	3 50	3 85	4 20	4 55	4 90	5 25	5 60
No. 707 Special Steel, 13x15 gauge ..	2 64	2 97	3 30	3 63	3 96	4 29	4 62	4 95	5 28

We furnish any of the above Saws in Silver-Steel. Prices quoted on application.

# ATKINS AUCKLAND PATTERNS.

SAWS OF OUR MANUFACTURE FOR AUSTRALASIAN TRADE.

Special Crucible Tool Steel. Gas Tempered. Expert Workmanship. Fine Finish. Every Saw Warranted. Made Special to Meet Export Demand.



Space of teeth, 6 and 6½ feet, 1-inch; 7 feet, 1½ inches; 7½ feet, 1¼ inches; 8 and 8½ feet, 1⅜ inches; 9 to 10 feet, 1½ inches. Space between sections of teeth, 2½ inches.

**List Price, Without Handles.**

	5 ft.	5½ ft.	6 ft.	6½ ft.	7 ft.	7½ ft.	8 ft.	8½ ft.	9 ft.	9½ ft.	10 ft.
No. 7 Special Steel.....	\$3 50	3 85	4 20	4 55	4 90	5 25	5 60	6 54	6 93	7 32	7 70
No. 46 Silver-Steel.....	4 10	4 80	5 60	6 40	7 30	8 30	9 30	11 58	12 26	12 94	13 63



Space of teeth, 6 and 6½ feet, 1-inch; 7 to 10 feet, 1¼ inches. Space between sections of teeth, 2 inches.

**List Price, Without Handles.**

	5 ft.	5½ ft.	6 ft.	6½ ft.	7 ft.	7½ ft.	8 ft.	8½ ft.	9 ft.	9½ ft.	10 ft.
No. 8 Special Steel.....	\$3 50	3 85	4 20	4 55	4 90	5 25	5 60	6 54	6 93	7 32	7 70
No. 47 Silver-Steel.....	4 10	4 80	5 60	6 40	7 30	8 30	9 30	11 58	12 26	12 94	13 63



### ATKINS CROSS-CUT SAWS FOR EXPORT.



Space of teeth, all sizes,  $1\frac{1}{4}$  inches. Space between sections of teeth,  $2\frac{7}{8}$  inches;

**List Prices, Without Handles.**

	5 ft.	5½ ft.	6 ft.	6½ ft.	7 ft.	7½ ft.	8 ft.	8½ ft.	9 ft.	9½ ft.	10 ft.
No. 9 Special Steel.....	\$3 00	3 30	3 60	3 90	4 20	4 50	4 80	5 61	5 94	6 27	6 60
No. 48 Silver-Steel.....	4 10	4 80	5 60	6 40	7 30	8 30	9 30	11 58	12 26	12 94	13 63



Space of teeth in 5-foot saws, 1-inch. All other sizes,  $1\frac{1}{4}$  inches. Space between sections of teeth,  $1\frac{1}{4}$  inches.

**List Prices, Without Handles.**

	5 ft.	5½ ft.	6 ft.	6½ ft.	7 ft.	7½ ft.	8 ft.	8½ ft.	9 ft.	9½ ft.	10 ft.
No. 10 Special Steel.....	\$3 50	3 85	4 20	4 55	4 90	5 25	5 60	6 54	6 93	7 32	7 70
No. 49 Silver-Steel.....	4 10	4 80	5 60	6 40	7 30	8 30	9 30	11 58	12 26	12 94	13 63

ATKINS AUCKLAND PATTERNS.

We wish to call special attention to our Auckland Pattern of Cross-Cut Saws. The peculiar styles of teeth shown are the result of very careful study as to the best construction for different woods indigenous to New Zealand.

They are made of a very high-grade of Special Crucible Steel and Gas Tempered by our exclusive process; will retain their cutting edge remarkably.

Please note the wide range of styles of teeth shown and the minute variation in specifications, enabling the buyer to secure Cross-Cut Saws which will meet his requirements to a nicety.



Space of teeth, 6 to 7½ feet, 1-inch; 8 to 10 feet, 1¼ inches. Space between sections of teeth, 2¼ inches.

List Prices, Without Handles.

	5 ft.	5½ ft.	6 ft.	6½ ft.	7 ft.	7½ ft.	8 ft.	8½ ft.	9 ft.	9½ ft.	10 ft.
No. 15 Special Steel.....	\$3 50	3 85	4 20	4 55	4 90	5 25	5 60	6 54	6 93	7 32	7 70
No. 50 Silver-Steel.....	4 10	4 80	5 60	6 40	7 30	8 30	9 30	11 58	12 26	12 94	13 63



**ATKINS  
SPECIAL PATTERNS FOR EXPORT.**

**TASMANIAN PATTERN, No. 241.**



Width of Gullets  $\frac{3}{4}$ -inch; Depth of Gullets  $1\frac{1}{4}$ -inch; Distance from point to point  $1\frac{3}{8}$ -inch.

**List Prices, Without Handles.**

	4 ft.	5 ft.	5½ ft.	6 ft.	6½ ft.	7 ft.	7½ ft.	8 ft.
No. 241 Special Steel.....	\$2 40	3 00	3 30	3 60	3 90	4 20	4 50	4 80
No. 41 Silver-Steel.....	3 10	4 10	4 80	5 60	6 40	7 30	8 30	9 30

**WEST AUSTRALIA PATTERN, No. 242.**



Width of Gullets  $\frac{5}{8}$ -inch; Depth of Gullets  $1\frac{3}{8}$ -inch; Distance from point to point  $1\frac{1}{8}$ -inch.

**List Prices, Jarrah Pattern, Without Handles.**

	4 ft.	5 ft.	5½ ft.	6 ft.	6½ ft.	7 ft.	7½ ft.	8 ft.
No. 242 Special Steel.....	\$2 40	3 00	3 30	3 60	3 90	4 20	4 50	4 80
No. 42 Silver-Steel.....	3 10	4 10	4 80	5 60	6 40	7 30	8 30	9 30

**TABS FOR CROSS-CUT SAWS.**

**LARGE AUCKLAND TABS.**



List price, per dozen, \$2.55.

**SMALL AUCKLAND TABS.**



List price, per dozen, \$1.80.

**COMMON EARS.**



List price, per dozen, \$0.45.  
Handles for common ears, pair, \$0.09.

ATKINS RUSSIAN PATTERN CROSS-CUT SAWS.



	3 ft.	3 1/2 ft.	4 ft.	4 1/2 ft.	5 ft.
14 Gauge .....	\$1 20	1 40	1 60	1 80	2 00
15 " .....	1 14	1 33	1 52	1 71	1 90
16 " .....	1 08	1 26	1 44	1 62	1 80
17 " .....	1 02	1 19	1 36	1 53	1 70

Saws over 5 feet long, not heavier than 14 gauge, list price 50 cents per foot.

ATKINS GANG SAWS.



	10 Ga.	11 Ga.	12 Ga.	13 Ga.	14 Ga.	15 Ga.
4 1/2 inches wide .....	\$0 66	64	62	60	58	56
5 " .....	69	67	65	63	61	59
6 " .....	74	72	70	68	66	64
7 " .....	79	77	75	73	71	69
8 " .....	84	82	80	78	76	74

Regular Russian Pattern Pit Saws are 12 inches wide at butt, 4 inches wide at point, 13 gauge. See illustration and price list, page 55.



**ATKINS  
PATENT CROSS-CUT SAW HANDLES.**



**No. 1. Loop Handle.**

Made of specially selected air-dried, straight grain hardwood stock. Socket and washer of extra high-grade cast steel. Loop of extra heavy, high tensile strength steel, spot electric welded. Packed 50 pairs in case, weighing 130 pounds.

List price, per pair, 36c.

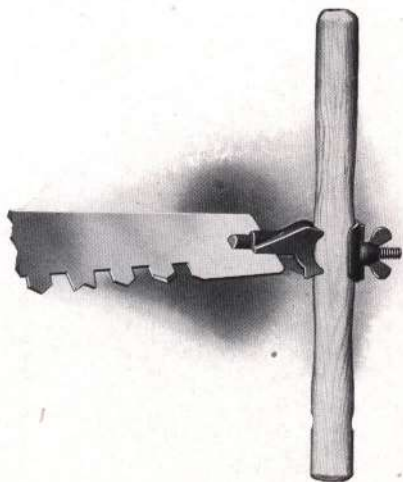

**No. 2. Reversible Handle.**

Illustration shows handle reversed. Made of carefully selected air-dried, straight grain hardwood stock. A very strong, quick adjusting handle. All malleable iron. Packed 50 pairs in barrel, weighing 135 pounds.

List price, per pair, 30c.



**No. 3. Loop Handle.**

Made of strictly selected hardwood stock, air-dried and seasoned. Malleable iron, patent swivel socket. Bolt made of high tensile strength, cold drawn steel, spot electric welded. Packed 50 pairs in case, weighing 115 pounds.

List price, per pair, 24c.

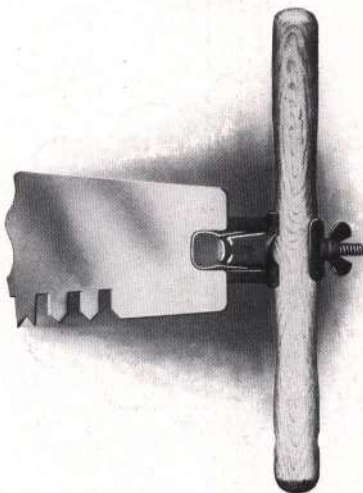

**No. 4.**

**Dexter Handle-Reversible.**

This is known as the Dexter Pattern. The wood parts are made from selected hardwood, thoroughly seasoned and finished. Extra heavy. All malleable iron. Packed 75 pairs in barrel, weighing 165 pounds.

List price, per pair, 30c.

## ATKINS PATENT CROSS-CUT SAW HANDLES.

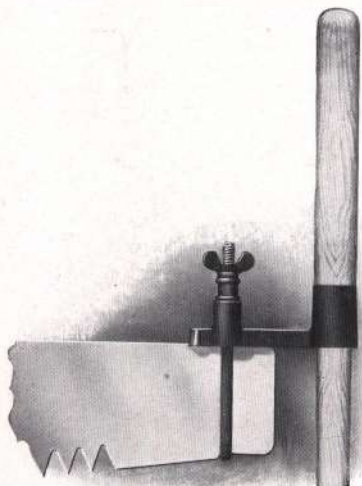

**No. 5. Bracket Loop Handle.**

This handle is made of specially selected hardwood, air-dried and seasoned. Extra strong malleable iron bracket. Loop of high tensile strength cold drawn steel, spot electric welded. Packed 50 pairs in barrel, weighing 135 pounds.

List price, per pair, 30c.

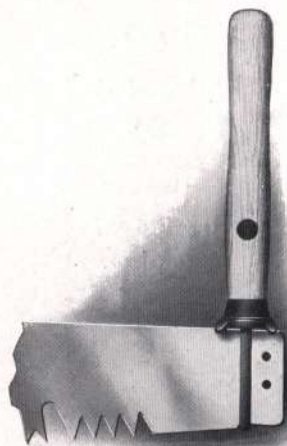

**No. 6 Loop Handle.**

Made of heavy stock, carefully selected, air-dried and seasoned. Cast steel patent swivel socket. Loop of extra heavy, high tensile strength, cold drawn steel, spot electric welded. Packed 150 pairs in barrel, weighing 200 pounds.

List price, per pair, 16c.

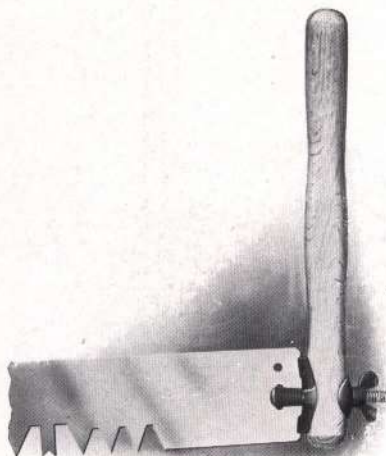

**No. 7. Reversible Handle.**

Selected, thoroughly seasoned hardwood stock. Cast steel washer and clasp. Extra high-grade malleable bolt and wing nut. Our exclusive pattern. Packed 100 pairs in barrel, weighing 160 pounds.

List price, per pair, 15c.



**No. 8. Loop Handle.**

Made of specially selected, thoroughly seasoned hardwood stock. Socket and washer of extra high-grade cast steel. Loop of extra heavy, high tensile strength steel, spot electric welded. Packed 100 pairs in barrel, weighing 200 pounds.

List price, per pair, 20c.



**ATKINS  
PATENT CROSS-CUT SAW HANDLES.**

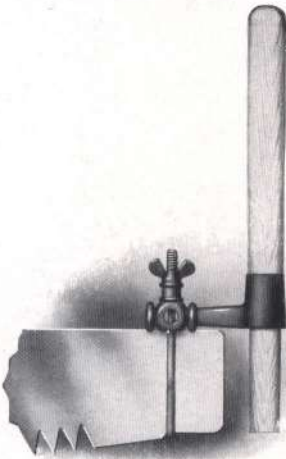

**No. 9. Bracket Handle—Reversible.**

This handle is of specially selected, air-dried and seasoned stock. Extra strong malleable iron bracket. Loop same as No. 5. Packed 50 pairs in barrel, weighing 135 pounds.

List price, per pair, 30c.

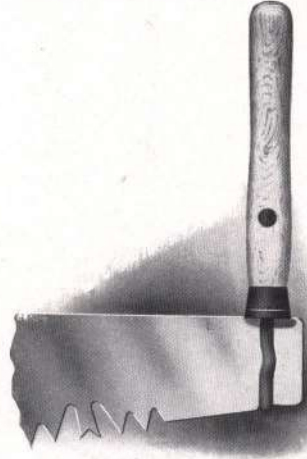

**No. 10. Loop Handle.**

Made of selected hardwood stock. Cast steel socket and washer. Loop of high tensile strength, cold drawn steel, spot electric welded. Packed 150 pairs in barrel, weighing 200 pounds.

List price, per pair, 14c.

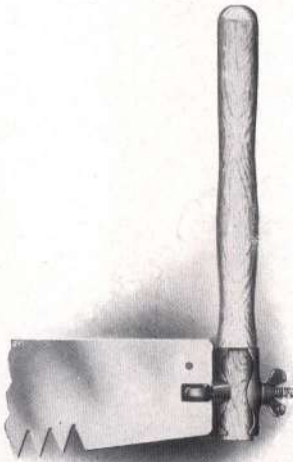

**No. 11. Reversible Handle.**

This is known as the Climax Pattern. It is made of thoroughly seasoned selected stock. Extra heavy cast steel clasp and washer. High-grade malleable iron bolt, with lock rivet feature preventing rivet from being detached. Packed 75 pairs in barrel, weighing 140 pounds.

List price, per pair, 15c.

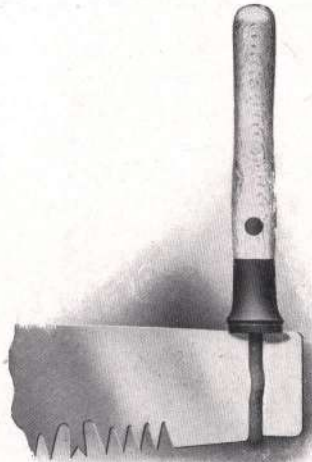

**No. 12. Loop Handle.**

A strictly high-grade handle, containing special features found in no other. It is impossible to break it through screwing the handle. Made of extra carefully selected hardwood stock, air-dried and seasoned. The socket, washer and nut of extra high-grade malleable iron. Loop extra heavy, of high tensile strength, cold drawn steel, spot electric welded. Packed 50 pairs in case, weighing 125 pounds.

List price, per pair, 40c.

## ATKINS PATENT CROSS-CUT SAW HANDLES.

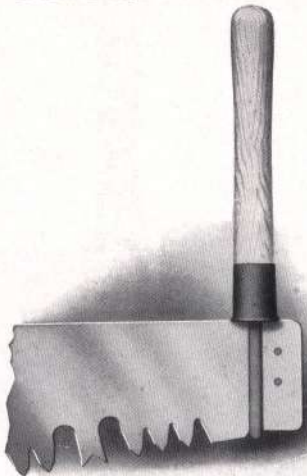

**No. 13X.**

Made of strictly high-grade, carefully selected hardwood stock. Cast steel socket with specially hardened face or bearing part on saw. Has no glued up plug. Loop of high tensile strength, cold drawn steel, spot electric welded. Packed 50 pairs in case, weighing 80 pounds. List price, per pair, 30c.

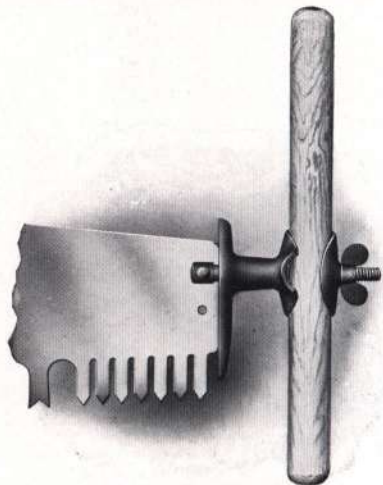

**No. 14. Reversible Handle.**

Specially adapted to the Pacific Coast. Clasp and washer made of extra strong high-grade malleable iron. Fitted with machine turned steel bolt, with special rivet feature enabling quick action in removing from saw. Packed 50 pairs in case, weighing 175 pounds.

List price, per pair, \$1.00.

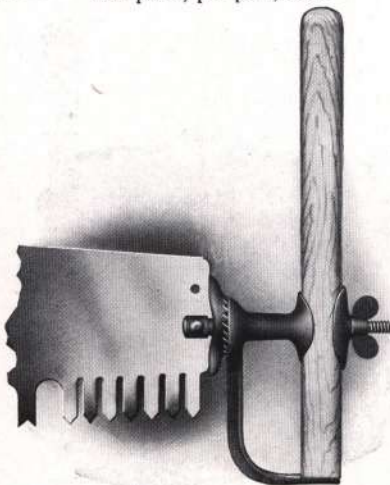

**No. 15. Reversible Handle.**

Another popular Pacific Coast pattern. Closed guards. Clasp, standard and washer of extra heavy malleable iron. Special ratchet adjustment for sawing at any angle. Machine turned steel bolt. Packed 50 pairs in case, weighing 195 pounds.

List price, per pair, \$1.00.



**No. 16. Loop Handle.**

A very popular, light-weight pattern made of carefully selected stock, malleable iron cuff and loop. Fitted with right and left hand threads, saving time in adjustment. Wooden parts not weakened by boring. Packed 50 pairs in case, weighing 140 pounds.

List price, per pair, 50c.

**No. 17. Loop Handle.** Same style as No. 16, heavy pattern. Packed 50 pairs in case, weighing 140 lbs. List price, per pair, 55c.



**ATKINS  
PATENT CROSS-CUT SAW HANDLES.**



**No. 20. Loop Handle.**

This is a very strong, light handle. Made of specially selected air-dried and seasoned stock. The socket is of highest grade ferrule steel with a patented swivel feature adding to the ease of adjustment. The loop is of extra heavy high tensile strength, cold drawn steel, spot electric welded. Packed 50 pairs in case, weighing 100 pounds.

List price, per pair, 36c.

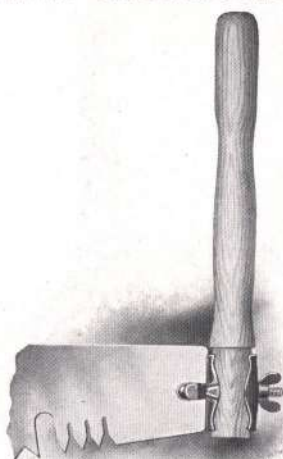

**No. 21. Reversible Handle.**

Climax Pattern, similar to No. 11, but lighter weight. Made of thoroughly seasoned selected stock. Extra heavy cast steel clasp and washer. High-grade malleable iron bolt with lock rivet feature which prevents rivet from becoming detached. Packed 75 pairs in barrel, weighing 140 pounds.

List price, per pair, 14c.

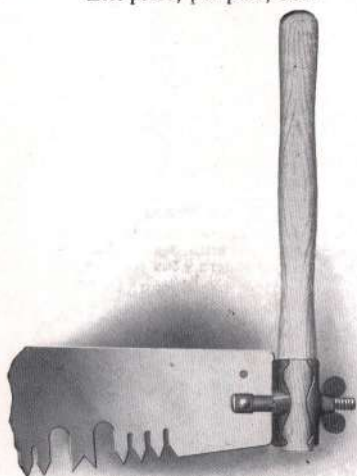

**No. 22. Reversible Handle.**

This is one of the most popular handles on the market. Extra strong and heavy and easy of adjustment. Climax pattern. Specially selected air-dried stock. Extra high grade malleable clasp and washer. Heavy machine turned steel bolt  $3\frac{1}{2}$  long and  $\frac{3}{8}$  thick with a special rivet feature allowing quick action in removing from the saw. Packed 50 pairs in case, weighing 100 lbs.

List price, per pair, 55c.

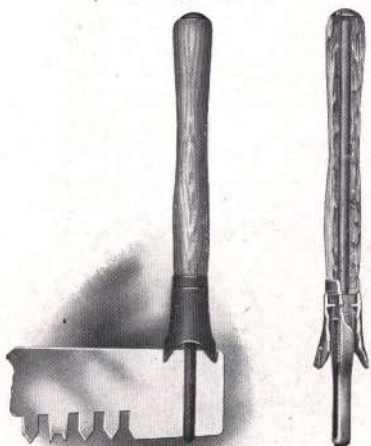

**No. 25. Swivel Handle.**

An extra strong handle, reinforced by heavy machine steel bolt running through the entire center. Socket, washer and loop of extra heavy, high-grade malleable iron. The stock is of carefully selected, thoroughly dried hardwood. Packed 50 pairs in case, weighing 175 pounds.

List price, per pair, 36c.

## ATKINS PATENT CROSS-CUT SAW HANDLES.

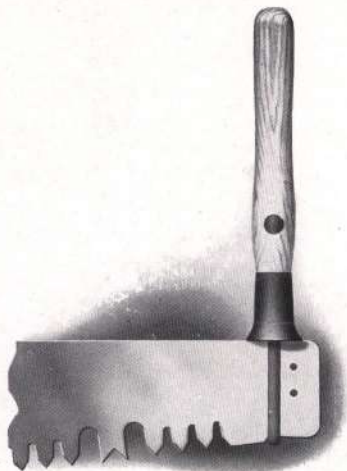

**No. 26. Loop Handle.**

Made of good quality hardwood thoroughly seasoned. The socket is of high-grade malleable iron. The loop of extra heavy high tensile strength, cold drawn steel, spot electric welded. Mechanically, we believe this to be the most practical swivel handle on the market. Packed 100 pairs in barrel, weighing 175 pounds.

List price, per pair, 24c.



**No. 108. Loop Handle.**

For description of this handle, see Loop Handle No. 8. This is a very fancy, highly finished handle, 12 inches long, varnished and polished. The loop is tinned and the washer and ferrule black baked Japan. Packed 50 pairs in case, weighing 130 pounds.

List price, per pair, 27c.

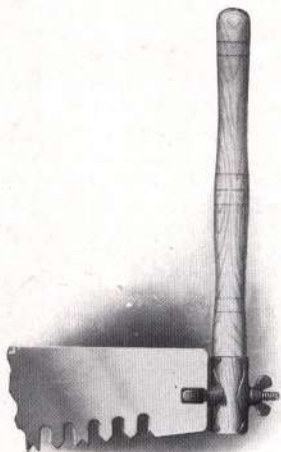

**No. 111. Reversible Handle.**

This handle is similar in construction to the No. 11, but is very highly finished. The handle is 15¼ inches long, carved, varnished and polished. The clasp and washer are baked black Japan. The bolt and wing nut are tinned. Packed 50 pairs in case, weighing 110 pounds.

List price, per pair, 22c.



**One Man Saw Handle, No. 2.**

This is made of carefully selected hardwood, thoroughly seasoned and dried. Varnished edge, well finished. Easy grip pattern. Saw screws extra.

List price, per dozen, \$3.00.



**Supplementary Handle for  
One Man Saws.**

Made of thoroughly seasoned, air-dried hardwood stock. Socket and washer of high-grade ferrule steel. Malleable iron bolt with locked rivet feature, preventing rivet from becoming detached.

List price, per dozen handles, \$1.75.



# Atkins Saw Tools

As in everything else that we manufacture, we have taken the lead in making Tools suitable for fitting Cross-Cut, Hand and other Saws in a proper manner, so that they will do satisfactory work. So marked has been our success in the tool line that within the last few years several manufacturers have been trying to beguile the trade with base imitations, claiming that their tools would do the work "as well as the 'ATKINS.'"

We refer particularly to our:

"EXCELSIOR,"

"PERFECTION,"

"IDEAL,"

"LEADER," ,

"DEXTER" AND

"CRITERION"

Tools, as illustrated in the following pages. These tools are all made under letters patent, and are of highest grade material and workmanship. We guarantee that there is nothing else on the market that can equal them for efficiency in rapid and correct work.

We invite the careful attention and scrutiny of the trade to this subject, believing that it will be found, by comparing our tools with any of the imitation tools, that there will be no question in the minds of every one as to the superiority of the ATKINS Tools.

## ATKINS PERFECTION SAW TOOLS.

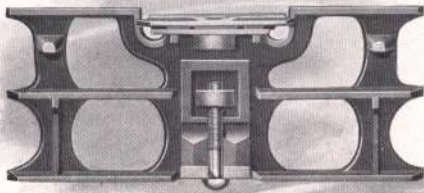

**The Perfection Saw Tool.**

The Perfection set of tools comprises a combined Jointer, Raker Tooth Gauge and Side File, Tooth Set Gauge, a No. 1 Criterion Saw Set and a fine Steel Hammer specially adapted to use with the Criterion Set. The Combined Jointer, Raker Tooth Gauge, Side File and No. 1 Criterion Set, makes the most complete set of Saw Tools ever offered to the public. It is Perfection.

Price, per dozen sets, \$15.00.

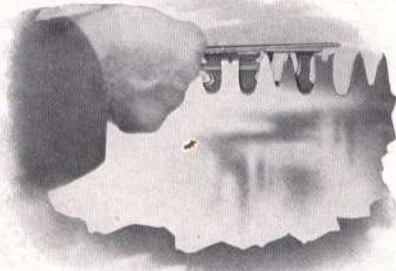

**Raker Gauge.**



**Tooth Set Gauge.**

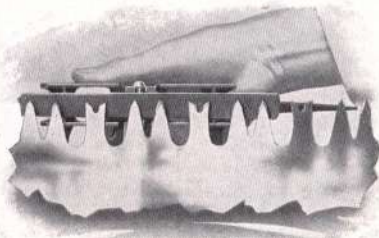

**Side File.**

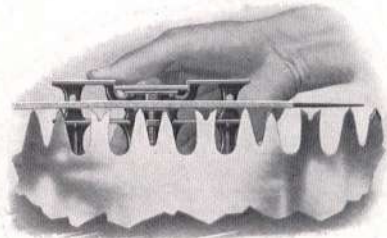

**Jointer.**

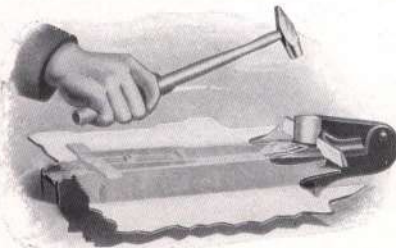

**No. 1 Criterion Saw Set.**

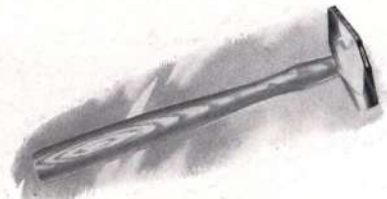

**Hammer.**



## ATKINS IDEAL SAW TOOLS.

It is a well known fact that in order to secure the best service, each tooth as well as each raker of a Cross-Cut Saw, should be absolutely uniform.

This raker has quite as much to do with the proper performance of the Saw as have the cutting teeth. In order to enable the filer to turn out a Saw as perfect as new, we have devised our IDEAL SAW TOOLS.

By the use of the tool as a Jointer, Raker Tooth Gauge or Side File there can be no variation in the teeth, and the advantage of a Setting Anvil that will operate without removing the Saw from its clamps or vise is apparent. We believe these to be the most practical tools on the market and recommend them in the highest terms.

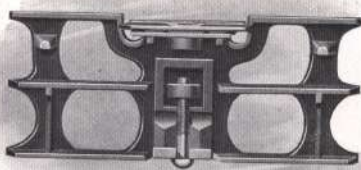

**Atkins Ideal Saw Tool.**

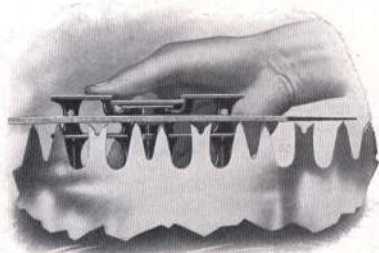

**Jointer.**

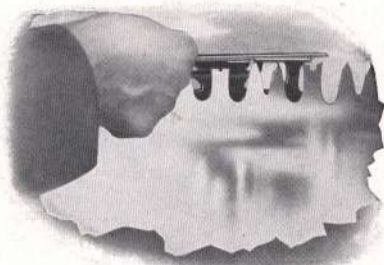

**Raker Tooth Gauge.**

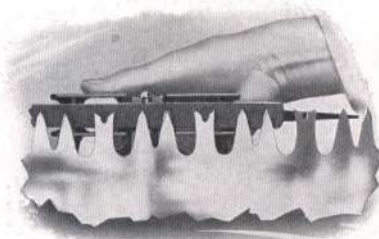

**Side File.**

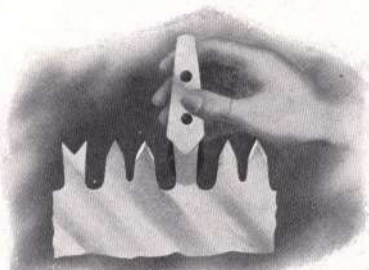

**Raker Swage.**

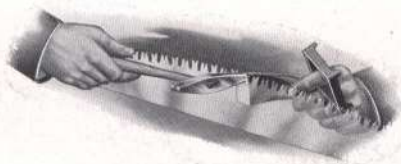

**Pistol Grip Anvil.**

**Price, list, \$15.50 per Dozen.**

## ATKINS NICKEL-PLATED EXCELSIOR SAW TOOLS.

This is a new and strictly high-grade fancy outfit. The Tools are similar in construction to the No. 2 Excelsior, shown on preceding page, but very finely finished and nickel-plated (not polished nor buffed.)

The set consists of a Combination Jointer, Raker Tooth Gauge and Side File, a Setting Block and Set Gauge. These are packed in a very attractive INDIVIDUAL BOX, COVERED WITH FANCY PAPER AND A BEAUTIFULLY LITHOGRAPHED LABEL IN BLUE, RED, YELLOW AND GOLD.

They are ready and easy sellers because attractive in appearance and price and at the same time most effective tools.



**Combination Jointer, Gauge  
and Side File.**



**Tooth Set Gauge.**



**Setting Block.**



**The Beautiful, Attractive Package.**

List price, per dozen, \$9.00.



## ATKINS PATENT EXCELSIOR SAW TOOLS No. 1.

WITH IMPROVED PATTERN SET BLOCK.

OVER A MILLION SETS SOLD.

This set of tools comprises a combined Jointer, Raker Tooth Gauge and Side File, a patented Channeling Set Block and a Set Gauge. The No. 1 Excelsior Tool differs from the No. 2 only in the Setting Block, the Improved Channeling Set Block being included with the No. 1, and the Original Pattern Set Block with the No. 2.

Put up one set complete in a neat paste-board box with full directions for use.

List price, per dozen, \$7.00.



Atkins Excelsior Saw Tool No. 1.

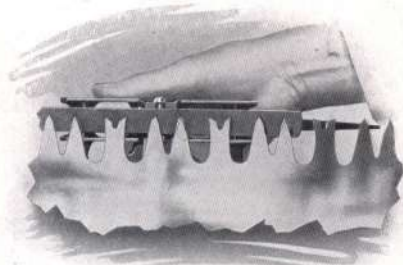

Side File.

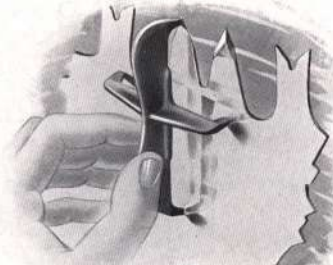

Tooth Set Gauge.

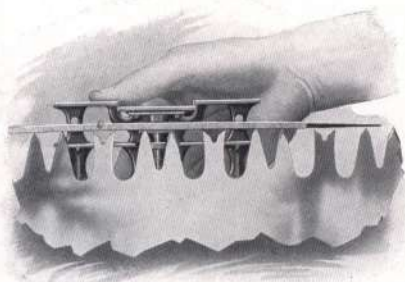

Jointer.

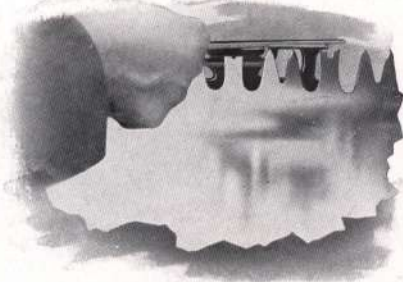

Raker Gauge.

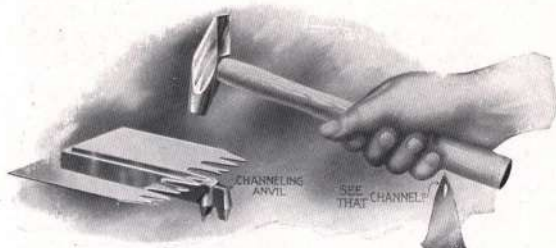

Channeling Set Block.

## ATKINS PATENT EXCELSIOR SAW TOOLS No. 1.

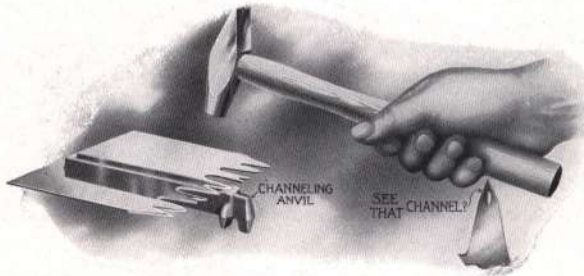

### DIRECTIONS FOR USE.

In fitting a saw, the teeth should first be jointed, or made uniform in length. To accomplish this, place a nine-inch file in the Jointer, as shown in cut, and by means of the large screw, spring it to suit the curve of the saw, and pass it lightly over the points of the teeth until it touches the shortest tooth; then place the tooth gauge over the cleaner drag teeth, as indicated in cut, and file them down to the gauge. Now, if the saw requires setting, lay the setting block on a log with a place leveled to receive it, or end of a block of wood, and lay the saw upon the setting block so that the point of the tooth to be set projects over the apex of the beveled surface fully one-quarter of an inch, bringing the point of tooth to the position as shown in the cut.

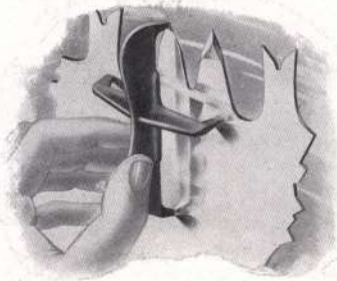

**Tooth Set Gauge.**

The tooth being in position, give two or three strokes with a light hammer on the sides of the tooth, over the apex, fully one-quarter of an inch from the point, which will usually give the required set. Then move tooth forward over the bevel or Channeling Block, and strike the tooth a sharp blow directly over the point. This will make a slight depression below the point of the tooth, which serves to keep the cutting edges flush, thus giving them greater cutting power and relieves the pressure on back of the tooth. Regulate the set by gauging each tooth with the tooth-

gauge; take it in the left hand and place it against the side of the saw. (See cut.) The point on the short end indicates the least set, and the point on long end indicates a little more set. The side file should be used to remove any feather-edge or burr left in filing, and even the set perfectly. This can be done when the saw is in the vise or filing clamp. Place an eight-inch mill bastard file in the recess on the side file; tighten the screws holding the file. Be particular that the saw is placed firmly in the clamp. Pass the center of the file lightly against the teeth until the burr is removed and the set evened up. Care should be exercised not to use the side file more than is necessary to remove the feather-edge and even up the set.

The wrench may be used to lessen the set if necessary, but should never be used to set the teeth. This should be done only with a hammer upon the setting block, or any hard and slightly beveled surface.

Notice carefully the manner in which the saw is filed when new, and file nearly as possible in the same manner.

To secure the best results, our Diamond Tooth (both Silver-Steel and Special Steel) and Dexter Saws should be sharpened after being set.



**ATKINS  
PATENT EXCELSIOR SAW TOOLS No. 2.  
WITH ORIGINAL PATTERN SET BLOCK.**

This set of tools comprises the best quality combined Jointer, Raker Tooth Gauge and Side File, nicely finished and made true and correct in every particular, in every way the same as furnished with No. 1 Excelsior. It also includes a plain, but good quality of Set Block, together with Set Gauge. The only difference between the No. 1 and No. 2 Excelsior Saw Tools is in the Set Block, which is slightly cheaper in the No. 2 Combination.

Put up one set complete in neat pasteboard box with full directions for use.

List price, \$6.50 per dozen.

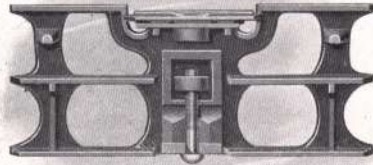

**Atkins Excelsior Saw Tool No. 2.**

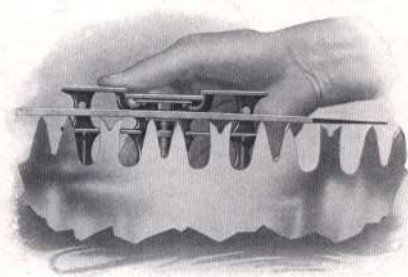

**Jointer.**

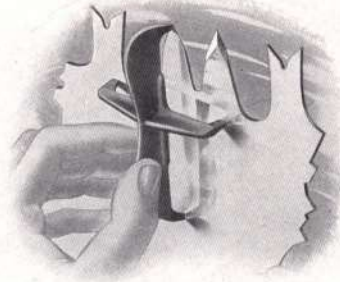

**Tooth Set Gauge.**

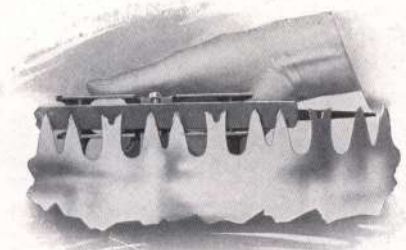

**Side File.**

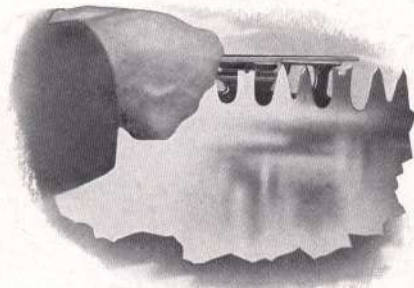

**Raker Gauge.**



**Setting Block.**

## ATKINS EXCELSIOR SAW TOOL No. 5.

The No. 5 is a marked improvement over any other device designed for similar use.

The special feature in connection with this tool is the

### EXTRA HARD TOOL STEEL BAR

Used for jointing, which overcomes the possibility of the teeth wearing A GROOVE ON THE UNDERSIDE of the bar, as is inevitable with others.



**Side File.**

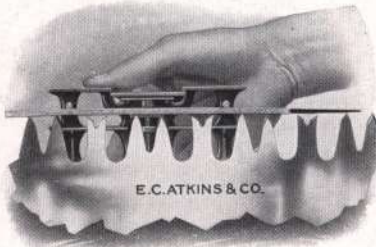

**Jointer.**



**Raker Gauge.**



**Tooth Set Gauge.**



**Channeling Set Block.**

The set comprises a combination Side File, Jointer, Tooth Gauge, a Setting Block and a Set Gauge. Through its use it is a simple matter to file each cutting point and raker tooth to an exactly proper and uniform point. The Set Gauge regulates the degree of set to be given each cutting point for different classes of timber. The Setting Block enables the user to safely set the teeth of very high tempered saws with safety. Atkins Excelsior Tool No. 5 is adapted for any style of Diamond Point Saws and is especially desirable for use in fitting Atkins High-Grade Silver-Steel Rex and Perfection. Directions for using, same as Excelsior No. 1, see page 118.

List Price, per dozen, \$8.50.



## ATKINS "REX" COMBINED SAW TOOL.

This saw tool combines a jointer, slotted plate for adjusting the length of the raker teeth and a gauge for adjusting the swage of the raker teeth in cross-cut saws.



**Atkins "Rex" Combined Saw Tool.**

### DIRECTIONS FOR USE.

In fitting the saws the teeth should first be jointed or made uniform in length. To accomplish this place a 9-inch file in the jointer as shown in the cut and by means of the screw tighten the file in place and pass it lightly over the points of the teeth until it touches the shortest tooth. If the cleaner or drag teeth are to be shortened, place the tooth gauge over the cleaner or drag teeth as indicated in the cut and file them down to the gauge, afterward filing them squarely across to a point as desired. If it is desired merely to swage the point of the rakers this may be done with a light blow of the hammer on the extreme point of the raker teeth, (though for this purpose we strongly recommend our Raker Tooth Swage, a very simple, cheap, but effective device) and the relative position of this point may be accurately gauged by the application of the swaging gauge as shown in the cut.

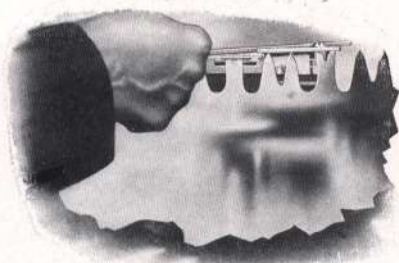

**Adjustment for Shortening Rakers.**

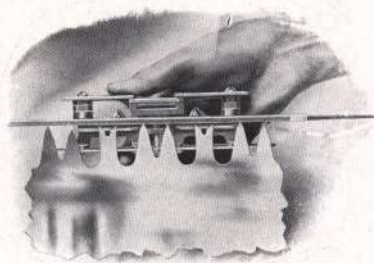

**Joining the Teeth.**

The sides of this tool, to which are fastened two pieces of hardened steel, make a very satisfactory straight edge to determine the relative position of the points of the various cutting teeth.

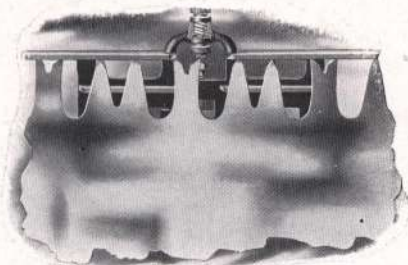

**Gauging the Swaged Rakers.**

List price, per dozen, \$12.00.  
Put up in a neat cardboard box.

## ATKINS PATENT LEADER SAW TOOLS.

This set consists of our new "Leader" Combined Jointer, Raker Tooth Gauge and Side File; in connection with the Setting Block and Set Gauge, the same as in our well-known Excelsior Set No. 1. The features of the combined tool, although somewhat different from the Excelsior, are easily understood and the same instructions will apply to both.

Put up one set complete in a neat pasteboard box, with full directions for use.

List, per dozen, \$6.00.



**Atkins Leader Saw Tool.**

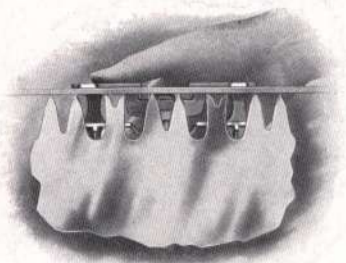

**Jointer.**

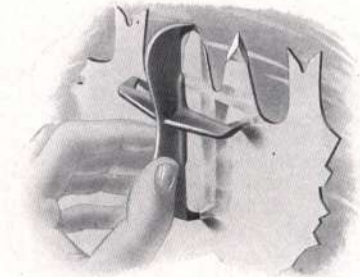

**Tooth Set Gauge.**

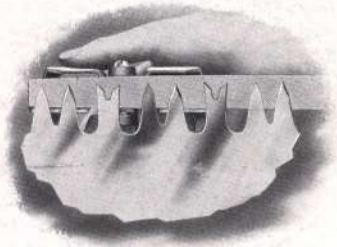

**Side File.**

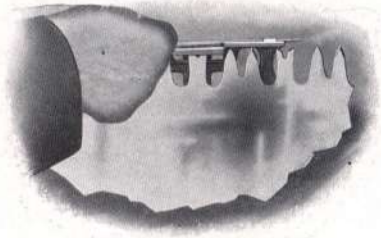

**Raker Gauge.**

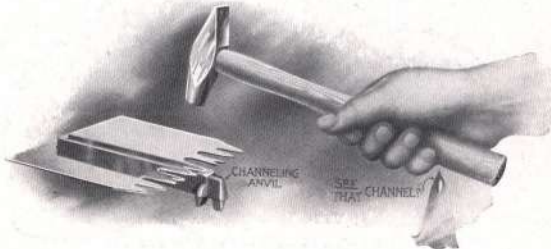

**Setting Block.**



## ATKINS DEXTER SAW TOOLS.

(Patented December 3, 1889.)

**Raker Tooth Gauge, Jointer and Side File Combined in One Tool.**

Price, per dozen, \$4.00.

### TO JOIN THE TEETH.

In filing a saw the teeth should first be jointed and made uniform in length. To accomplish this place an 8-inch mill bastard file in the Jointer, as shown in the cut; the file being held firmly in place by use of the thumbscrew, which will spring the file to suit the curve of the saw. Pass the file lightly over the point of the teeth until it touches the shortest tooth.

### TO GAUGE THE RAKERS.

The gauge plate is made adjustable, and can be set to point the Raker for hard or soft wood. Place the tooth gauge over the clearer drag teeth, as indicated in cut and file them down to the gauge.



**Dexter Saw Tool.**

### TO SET THE TEETH.

Fine, high-tempered Cross-Cut Saws should never be set with a spring set. A beveled Setting Block, or better, the Atkins Criterion Saw Set, with a light hammer, should be used. If Setting Block is used, lay the saw upon the Setting Block so that the point of the tooth to be set projects over the apex of the beveled surface fully one-quarter of an inch. The tooth being in position, give two or three strokes with a light hammer over the apex, fully one-quarter of an inch from the point, which will usually give the required set.

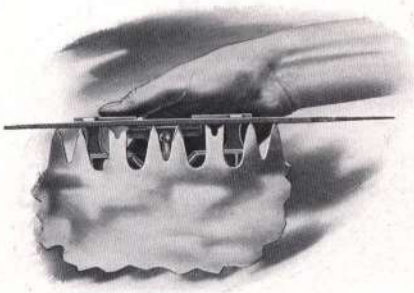

**Jointer.**

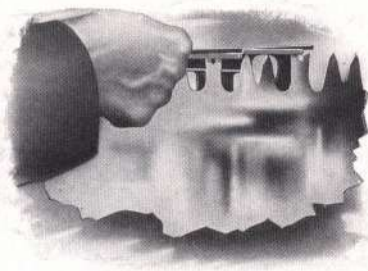

**Raker Gauge.**

### TO SIDE FILE.

The Side File should be used to remove any uneven edge or burr left in filing, and even the set perfectly. This can be done when the saw is in the vise or filing clamp. Place an 8-inch mill bastard file in the recess of the Side File (see cut,) the file being held firmly in place by use of the thumb-screw. Pass the center of the file lightly against the tooth until the burr is removed and the set evened up. Care should be exercised not to use the Side File more than is necessary to remove the feather edge and even up the set.

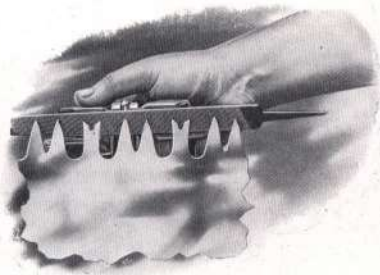

**Side File.**

N. B. Notice carefully the manner in which the saw is filed when new, and file as nearly as possible in the same manner.

## ATKINS IMPROVED CRITERION SAW SET

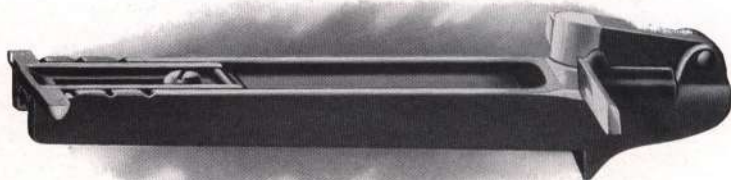

Price, per dozen, \$8.00.

**For All Kinds of Cross-Cut, Hand, Wood  
and Other Small Saws.**

The only proper way to set these saws is with a hammer set.

The Criterion Set has a die which rests on the tooth; the die being struck instead of striking the tooth itself with the hammer. This imparts a more even set and removes the liability of breakage.

The Improved Criterion Set has a pointed die adapting it to any size of tooth.

The Criterion Set is adjustable, so that any desired degree of set may be secured.

The Criterion Saw Set is made of best refined malleable iron, lacquered a rich brown. The die and anvil are drop-forged from the finest tool steel and properly hardened. The set is fully warranted.

## HAMMERS FOR SETTING SAWS.

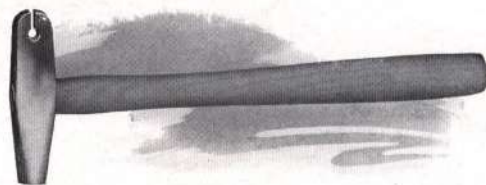
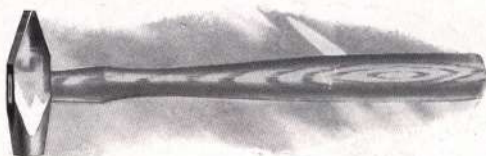

**Special Slotted Hammer, used often in setting saws.**

Both the above are of very fine tool steel, handsomely finished, handles of carefully selected hardwood.

Price, per dozen, \$3.50.



**ATKINS AAA SAW SET No. 4.**

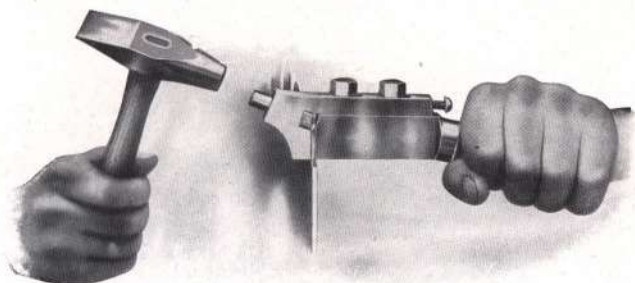

**FOR CROSS-CUT SAWS.**

The action of this device is clearly shown in the above illustration. The hammer blow reaching the tooth through the plunger prevents the likelihood of breaking the saw teeth. The amount of set may be regulated by moving the top slide. Absolute uniformity is assured as well as maximum speed. Given the amount of bevel, and the slide may be instantly set to proper position, when by simply placing the tool over the point of the tooth and striking the plunger one blow, a perfectly uniform set, located properly on the tooth, is secured.

Made of fine crucible steel, handsomely finished, and packed one-half dozen in a box.

List price, per dozen, \$18.00.

**ATKINS AAA SAW SET No. 5.**



**FOR HAND SAWS.**

The above device operates on the same principle as the No. 4, the amount of set being regulated by moving the guide on the front up or down. Its advantages are obvious and it not only prevents the breaking of the saw teeth, but assures an absolute uniform set, precluding the possibility of setting the teeth too far down on the blade. After setting each alternate tooth the saw is reversed, thus enabling the operator to complete the process without changing the position of the set.

List price, per dozen, \$18.00.

## ATKINS CRITERION BAND SAW SET.

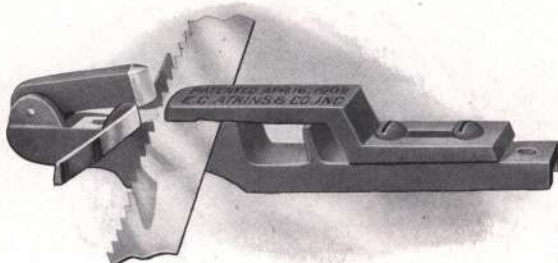

Price, per dozen, \$10.00.

This set is admirably adapted for setting Narrow Band Saws, Carpenters' Rip Saws and any saw having teeth of similar shape. The illustration shows the method of using the set, which is very simple. Hold saw firmly against the gauge, as shown; strike the point of every alternate tooth with a light hammer. Reverse the saw, placing it against the other side of the gauge, and set the remaining teeth.

The Criterion Band Saw Set is made of the best refined malleable iron, lacquered a rich brown. The die and anvil are drop forged from the finest tool steel and properly hardened. The set is fully warranted.

## ATKINS CHANNELING SET BLOCK.

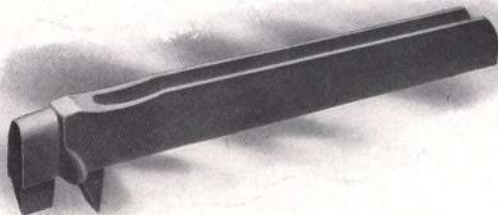

The above illustration represents our latest improved form of set blocks, and is used for setting and channeling the cutting teeth of Cross-Cut Saws, thereby producing a more durable set, and relieving the friction on the side of the teeth.

One of these set blocks is included with each set of our "Excelsior" No. 1, and "Leader" tools.

Regular quality, chilled iron .....	Per dozen, \$3 00
Old style set block .....	" 3 00
Set gauges .....	" 60
Extra quality, drop forged, tool steel .....	" 6 00



## ATKINS TOOTH AND RAKER GAUGE.

FOR REGULATING THE LENGTH OF CLEARERS AND THE WIDTH OF THE SET IN CROSS-CUT SAWS.

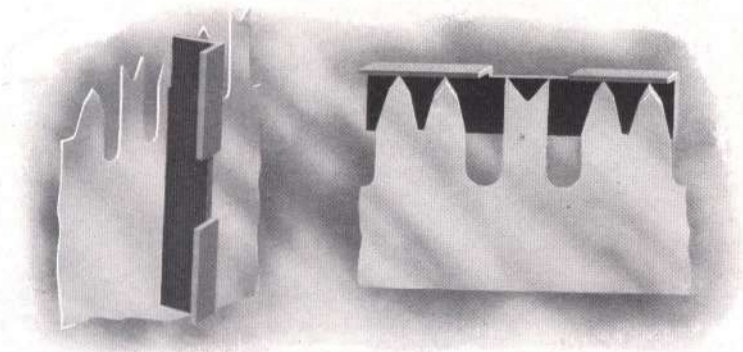

**Users of Cross-Cut Saws Will Find This Tool Indispensable.**

Price, Single Gauge, per dozen, 80 cents.

The cleaning teeth of all saws should be somewhat shorter than the cutting teeth, and although shortened, should be of uniform length throughout. The flange of the Gauge rests on the points of the cutting teeth, the cleaning teeth projecting through the opening in the center of Gauge. Reduce the projecting points by means of a file until arrested by the edge of Gauge, which cannot be cut with a file. Thus tooth after tooth can be rapidly and correctly reduced to an even length by any unskilled operator.

Our Single Gauge regulates the cleaners for hard wood, and our Double Gauge for both hard and soft wood. One end of the straight-edge of these Gauges has been slightly beveled, so that they may be used for gauging the set, as shown in cut.

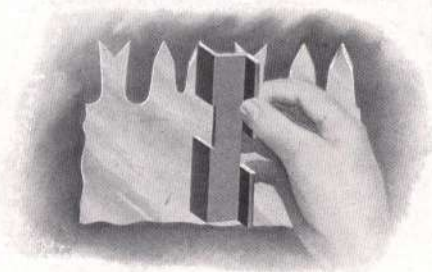

**Gauging the Set.**

Price, Double Gauge, per dozen, \$1.20.

## ATKINS LEVER SAW SET.

No. 1.

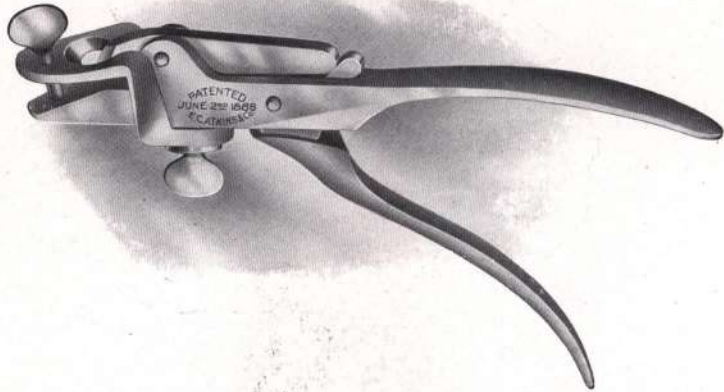

For Hand, Rip, Panel and all small saws, per dozen, \$8.00.

## ATKINS PATENT RAKER SWAGE.

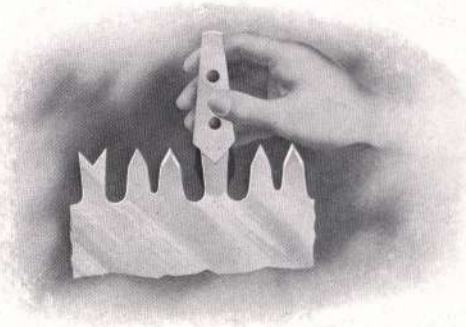

### For Swaging Raker Teeth of Cross-Cut Saws.

Many practical filers and users of cross-cut saws have adopted this plan of swaging or turning the points of the rakers slightly outward instead of jointing or filing them shorter. This leaves the raker with a little hook-like point, which clears out the kerf much more perfectly, producing long shavings instead of fine saw dust, thus enabling the sawyers to do a greater amount of work in a given time.

This has been accomplished by striking the point of the raker a light blow with the setting hammer, but there is danger of this point breaking off unless the temper is rather mild, and especially in winter when saws are sometimes fitted without warming. There is also a liability to turn one point more than the other, which prevents the best results.

To overcome these objections, the Raker Swage, shown in the accompanying illustration, has been devised by a practical sawyer, and has been heartily endorsed by all who have seen and used it. By its use the work is SAFELY and ACCURATELY done and in much less time than otherwise. The construction is so simple that no description is required. It is made of FINE TOOL STEEL, hardened to stand the wear, and will swage the rakers of any cross-cut saw.

Price, per dozen, \$3.00.

**ATKINS "PERFECT" SAW SET AND  
VISE COMBINED.**



**IT CAN BE ADJUSTED INSTANTLY TO THE DIFFERENT  
OPERATIONS.**

Cut shows the filing clamp ready for use. Jaws are rubber-cushioned. Practically noiseless. Can be tilted to any desired angle. Works on the lock lever principle. Fastened to bench with malleable iron screw clamp. Simple, strong, durable and easy to operate.

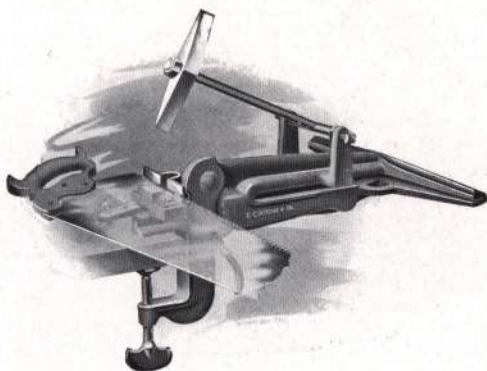

Same Tool adjusted for use as a Saw Set.

List price, each, \$6.00.



## ATKINS "PERFECT" SAW SET.

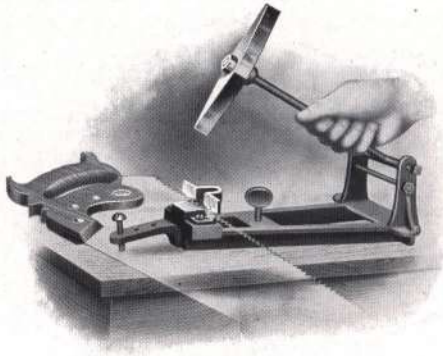

This device is so constructed that a uniform blow can be given to each tooth, thus insuring a perfectly even set throughout the blade. No danger of breaking the points of the most highly-tempered saw, even when operated by a novice. It is adjustable to any amount of set desired, and will set the finest, as well as the coarsest, tooth perfectly.

List price, \$3.50 each.

## THE ATKINS HAND SAW FILER.

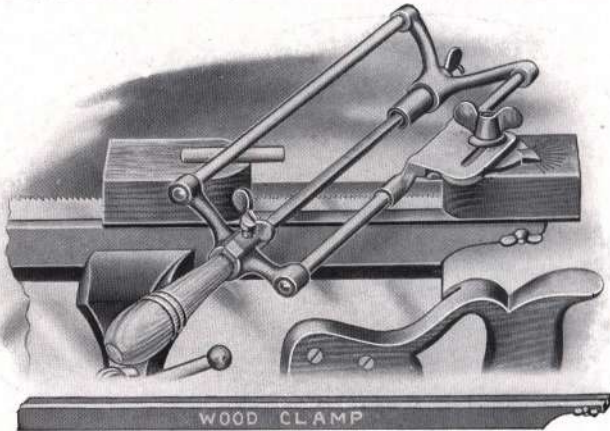

This saw-filing device is the most perfect tool for the purpose ever produced. By following the directions accompanying each filer a ten-year-old boy can file a saw correctly, bringing each tooth to the same bevel and pitch. It can be used with wood clamp in any ordinary vise or with iron saw clamp.

List price, per dozen, \$24.00.

## ATKINS NOISELESS SAW VISE.

**The Latest and Best. Rubber Cushioned Jaws. Strong and Durable, Heavily Japanned and Well Finished.**

(Invented by Chas. Ralston Walter.)

In general appearance the new Atkins Saw Vise is very similar to those of other well-known makes, but, while combining the merits and good points of all the old style patterns, it has many new features and advantages not incorporated in any of the others. All the weak points in other vises were carefully noted and overcome in the new Atkins. It is simple and neat, and will readily attract favorable attention from mechanics everywhere.

All the wearing parts are re-inforced. It is made of the best material and finely finished. Also has rubber cushions in the jaws to prevent the disagreeable noise. Will make no more noise than if filing a solid piece of iron.

The Vise operates with the lock lever principle and there is no chance of overstraining it, as is the case in others where the screw is used. The jaws are made to open and close by simply pushing same forward and back.

One of the most desirable features is the ease with which the saw can be gauged or adjusted with both hands (see cut of No. 3 A,) so that the teeth will be just the right height above the face of the jaws and the Vise instantly tightened without removing the hands.

Another good point—the Vise is set so low down on the bench that there is no leverage to cause vibration and in consequence is very rigid.

## THE ATKINS 1 AA SAW VISE.

**With 11-Inch Jaw.**

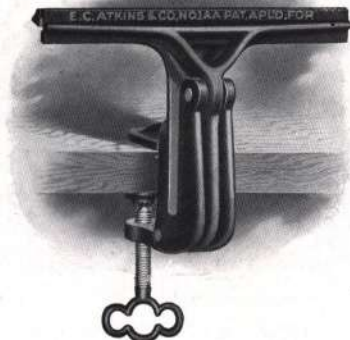

Has a malleable iron screw clamp for attaching to work bench, and can be readily detached and carried from place to place.

List price, per dozen, \$16.00.

## ATKINS NOISELESS SAW VISE.



### ATKINS 1A SAW VISE.

With 11-Inch Jaw.

Can easily be screwed to work bench or any place desired.

List price, per dozen, \$13.00.

### ATKINS 2A SAW VISE.

With 15-Inch Jaw.

Made to screw to work bench. Same style as No. 1A except jaw is longer.

List price, per dozen, \$15.00.

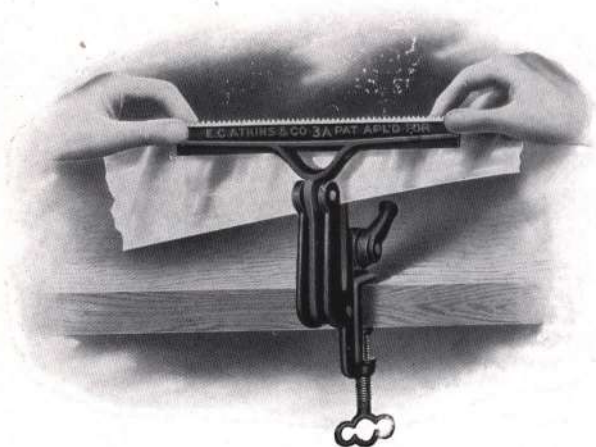

### ATKINS 3A SAW VISE.

With 11-Inch Jaw.

Fastened to bench with a malleable iron screw clamp. Readily detachable. Jaws are adjustable and can be tilted to any desired angle.

List price, per dozen, \$18.00.



**ATKINS "AAA" HAND SAW CLAMP.**

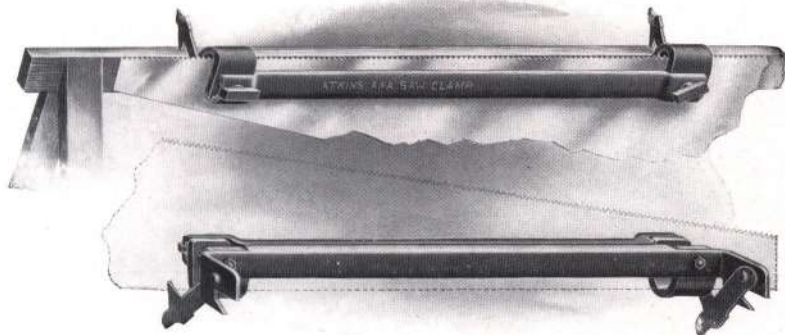

Patented May 21, 1907.

This Clamp weighs a little over one pound and will occupy about as much room as a chisel, and may be conveniently carried in any kit.

It may be attached to any square edge for immediate use, and instantly and easily detached.

It can be used for either jointing, setting or filing, and the saw being seated close to its work does not quiver and needs no wooden prop.

The advantages will be immediately apparent to all users of Saw Vises who have heretofore been obliged to carry with them a large, heavy, ungainly contrivance that was after all not as effective as the "AAA" Clamp. Nor has there been any device heretofore offered that was so easily attached to, or detached from any convenient bench or saw horse.

By referring to the above illustration, you will note that the saw is placed in the clamp with the tooth edge upward for filing only, all parts and teeth being easily accessible. For jointing and setting, the vise may be reversed by simply turning the arches at either end and placing the blade in the clamp back downward.

The Atkins "AAA" Saw Clamp sells at a popular price, and the advantages over any previous vise or clamp are so apparent that the user will recognize them immediately.

Packed three in a box.

**List Prices.**

Japanned .....	Per dozen, \$13 50
Nickled but not polished nor buffed .....	" 18 00

## Atkins Wood Saws

A glance through the following pages, showing our line of Wood Saws, Blades and Frames, will convince you of the unusually complete and varied assortments and combinations which we offer.

We are showing thirteen styles of Frames alone, and forty-two different Blades.

We make any combination of Frame or Blade desired. No. 100 Frame, for instance, is shown in combination with No. 1 Blade, making complete Saw No. 101. You may, however, buy any other style of Blade in connection with No. 100 Frame if desired.

No. 200 Frame is shown in combination with No. 2 Blade, making complete Saw No. 202. Frame No. 300 with the Blade No. 2 becomes No. 302, and so on.

Each Frame can thus be used in connection with any of our forty-two Blades, making a combination of that number of different saws for each style of Blade.

Our Blades are classified as "A," "B," "C" and "D." "A" grade is our very highest quality, Silver-Steel, and "D" our cheapest quality of steel.

We are giving this department careful consideration and are offering the finest line of Wood Saws on the market.

**ATKINS  
INDIVIDUAL WOOD SAW BOXES.**



Without extra charge, all Atkins Silver-Steel Wood Saws will hereafter be packed in individual boxes. This covers all Saws equipped with blades listed under classes A and B.

These boxes are 7 inches wide, 1-inch high and either 30 or 32 inches long, according to the size of the blade. They are made of a heavily coated manila stock, with patent fastenings in the ends for security, and a very handsome colored label is used on the top and sides. This makes a very attractive shelf package.

We are adding this extra cost because we believe that a package of this nature will be highly appreciated by both the dealer and consumer, and that through its use the already heavy demand for Atkins High-Grade Wood Saws will be increased.

The advantages of this package are obvious.

It not only converts a formerly unsightly piece of stock into a handsome piece of "shelf goods," but keeps the contents fresh and clean.

As each box is carefully numbered on the top and sides, any particular Saw desired may be immediately identified and easily wrapped for delivery.



ATKINS WOOD SAWS, COMPLETE.

ATKINS No. 101

Atkins "Special"  
Frame, No. 100  
Selected Stock  
High Finish  
Painted Red  
Tinned Rod

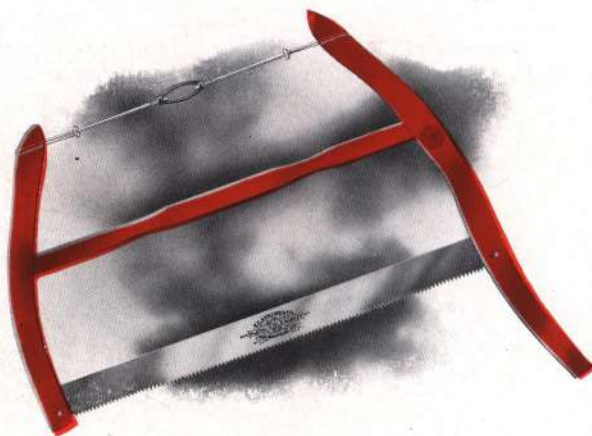

This is Atkins No. 100 Frame, with  
No. 1 Blade (30 inches.)

List price of other combinations of No.  
100 Frame (30-inch Blades)  
as follows :

No.....	101	102	103	104	105	106	107	108	109	110	111	112
Per dozen.....	\$13 25	9 00	14 50	14 00	14 00	14 50	14 50	13 25	14 00	14 00	16 10	16 10
No.....	113	114	115	116	117	118	119	120	121	122	123	124
Per dozen.....	\$15 50	12 00	10 50	14 00	10 25	10 25	14 00	16 10	15 50	14 00	11 00	14 00
No.....	125	126	127	128	129	130	131	132	133	134	135	136
Per dozen.....	\$14 00	10 25	11 00	11 00	16 10	15 10	9 00	14 00	15 10	12 75	9 75	9 00
No.....	137	138	139	140	141	142	148					
Per dozen.....	\$11 00	8 50	12 75	16 10	9 75	9 75	12 60					

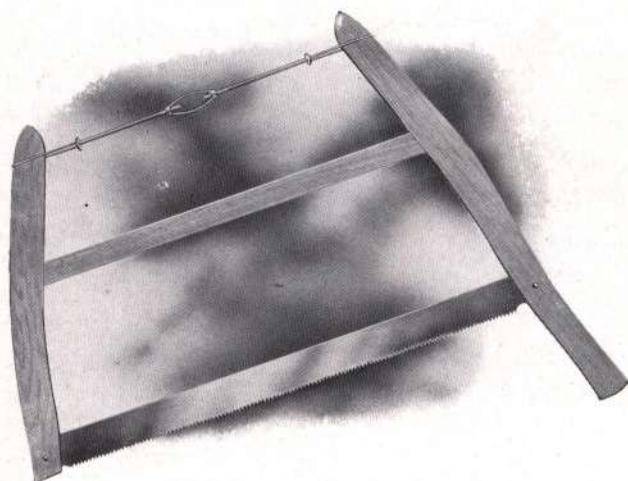

ATKINS  
No. 202

"O. K." Frame  
No. 200  
Not Painted  
Clipper Rod

This is Atkins No. 200 Frame  
with No. 2 Blade  
(30 inches.)

List price of other combina-  
tions of No. 200 Frame  
(30-inch Blades)  
as follows :

No.....	201	202	203	204	205	206	207	208	209	210	211	212
Per dozen.....	\$12 30	8 05	13 55	13 05	13 05	13 55	13 55	12 30	13 05	13 05	15 15	15 15
No.....	213	214	215	216	217	218	219	220	221	222	223	224
Per dozen.....	\$14 55	11 05	9 55	13 05	9 30	9 30	13 05	15 15	14 55	13 05	11 05	17 05
No.....	225	226	227	228	229	230	231	232	233	234	235	236
Per dozen.....	\$13 05	9 30	11 05	11 05	15 15	14 15	8 05	13 05	14 15	11 80	8 80	8 65
No.....	237	238	239	240	241	242	248					
Per dozen.....	\$11 05	7 55	11 80	15 15	8 80	8 80	11 65					

In ordering, specify "Wood Saws, Complete." Packed half dozen in a box.

## ATKINS WOOD SAWS, COMPLETE.

### ATKINS No. 302

**"O. K." Frame  
No. 300  
Painted Red  
Clipper Rod**

This is Atkins No. 300 Frame,  
with No. 2 Blade  
(30 inches.)

List price of other combinations of  
No. 300 Frame (30-inch Blades)  
as follows:

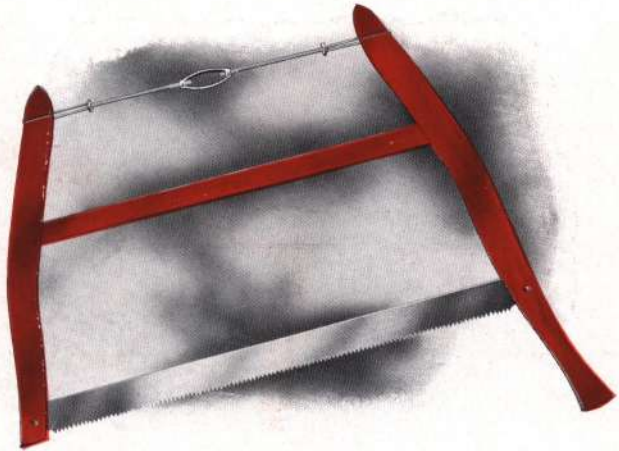

No.....	301	302	303	304	305	306	307	308	309	310	311	312
Per dozen.....	\$12 90	8 65	14 15	13 65	13 65	14 15	14 15	12 90	13 65	13 65	15 75	15 75
No.....	313	314	315	316	317	318	319	320	321	322	323	324
Per dozen.....	\$15 15	11 65	10 15	13 65	9 90	9 90	13 65	15 75	15 15	13 65	10 65	13 65
No.....	325	326	327	328	329	330	331	332	333	334	335	336
Per dozen.....	\$13 65	9 90	10 65	10 65	15 75	14 75	8 65	13 65	14 75	12 40	9 40	8 65
No.....	337	338	339	340	341	342	348					
Per dozen.....	\$10 65	8 15	12 40	15 75	9 40	9 40	12 25					

### ATKINS No. 506

**"Wood-Brace"  
Frame, Single  
Rivet, No. 500  
Selected Stock  
High Finish  
Painted Red  
Jumbo Tinned  
Rod**

This is Atkins No. 500 Frame with  
No. 6 Blade (30 inches.)

List price of other combinations of  
No. 500 Frame (30-inch Blades)  
as follows:

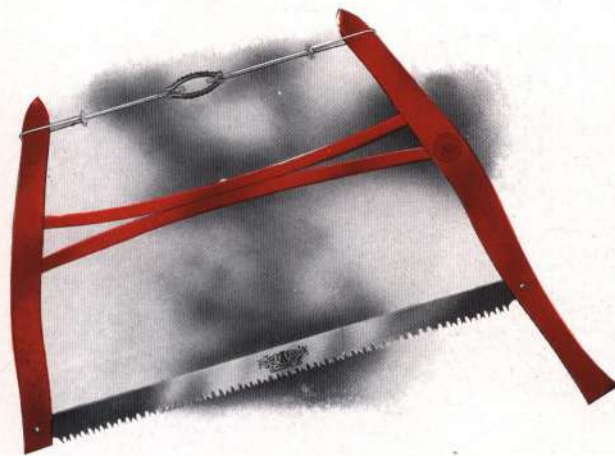

No.....	501	502	503	504	505	506	507	508	509	510	511	512
Per dozen.....	\$13 85	9 60	15 10	14 60	14 60	15 10	15 10	13 85	14 60	14 60	16 70	16 70
No.....	513	514	515	516	517	518	519	520	521	522	523	524
Per dozen.....	\$16 10	12 60	11 10	14 60	10 85	10 85	14 60	16 70	16 10	14 60	11 60	14 60
No.....	525	526	527	528	529	530	531	532	533	534	535	536
Per dozen.....	\$14 60	10 85	11 60	11 60	16 70	15 70	9 60	14 60	15 70	13 35	10 35	9 60
No.....	537	538	539	540	541	542	548					
Per dozen.....	\$11 60	9 10	13 35	16 70	10 35	10 35	13 20					

In ordering, specify "Wood Saws, Complete." Packed half dozen in a case knocked down.



ATKINS WOOD SAWS, COMPLETE.

ATKINS No. 609

"Wood-Brace" Frame  
Single Rivet, No. 600  
Painted Red  
Clipper Rod

This is Atkins No. 600 Frame, with No. 9  
Blade (30 inches.)

List price of other combinations of  
No. 600 Frame (30-inch Blade)  
as follows :



No.....	601	602	603	604	605	606	607	608	609	610	611	612
Per dozen.....	\$13 10	8 85	14 35	13 85	13 85	14 35	14 35	13 10	13 85	13 85	15 95	15 95
No.....	613	614	615	616	617	618	619	620	621	622	623	624
Per dozen.....	\$15 35	11 85	10 35	13 85	10 10	10 10	13 85	15 95	15 35	13 85	10 85	13 85
No.....	625	626	627	628	629	630	631	632	633	634	635	636
Per dozen.....	\$13 85	10 10	10 85	10 85	15 95	14 95	8 85	13 85	15 95	12 60	9 60	8 85
No.....	637	638	639	640	641	642	648					
Per dozen.....	\$10 85	8 35	12 60	15 95	9 60	9 60	12 45					

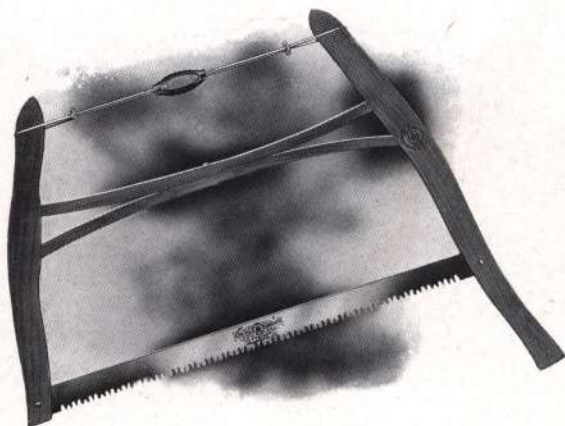

ATKINS No. 707

"Wood-Brace" Frame,  
Single Rivet, No. 700  
Selected Maple Stock  
Fine Natural Wood  
Finish  
Jumbo Tinned Rod

This is Atkins No. 700 Frame, with No. 7  
Blade (30 inches.)

List price of other combinations of No.  
700 Frame (30-inch Blades)  
as follows :

No.....	701	702	703	704	705	706	707	708	709	710	711	712
Per dozen.....	\$13 85	9 60	15 10	14 60	14 60	15 10	15 10	13 85	14 60	14 60	16 70	16 70
No.....	713	714	715	716	717	718	719	720	721	722	723	724
Per dozen.....	\$16 10	12 60	11 10	14 60	10 85	10 85	14 60	16 70	16 10	14 60	11 60	14 60
No.....	725	726	727	728	729	730	731	732	733	734	735	736
Per dozen.....	\$14 60	10 85	11 60	11 60	16 70	15 70	9 60	14 60	15 70	13 35	10 35	9 60
No.....	737	738	739	740	741	742	748					
Per dozen.....	\$11 60	9 10	13 35	16 70	10 35	10 35	13 20					

In ordering, specify "Wood Saws, Complete." Packed half dozen in a case.



## ATKINS WOOD SAWS, COMPLETE.

### THE "CANTI-LEVER"

**Strongest and Best Wood Saw Frame of the 20th Century**

#### ATKINS No. 821

**"Canti-Lever"  
Frame No. 800  
Selected Maple  
Stock  
Fine Natural Wood  
Finish  
Jumbo Tinned  
Rods**

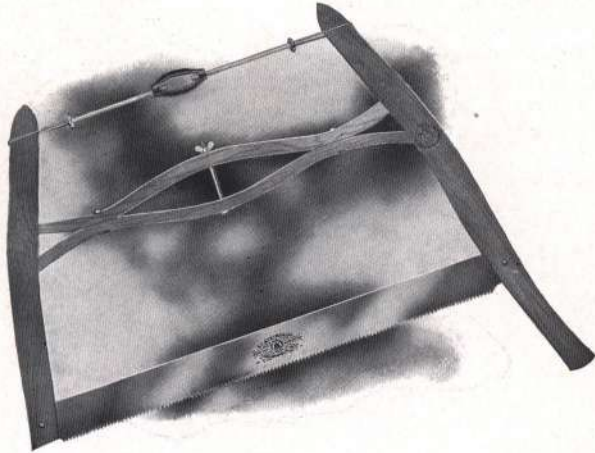

This is Atkins No. 800 Frame, with No. 21 Blade (30 inches.)

List price of other combinations of No. 800 Frame (30-inch Blades) as follows :

No.....	801	802	803	804	805	806	807	808	809	810	811	812
Per dozen.....	\$14 30	10 05	15 55	15 05	15 05	15 55	15 55	14 30	15 05	15 05	17 15	17 15
No.....	813	814	815	816	817	818	819	820	821	822	823	824
Per dozen.....	\$16 55	13 05	11 55	15 05	11 30	11 30	15 05	17 15	16 55	15 05	12 05	15 05
No.....	825	826	827	828	829	830	831	832	833	834	835	836
Per dozen.....	\$15 05	11 30	12 05	12 05	17 15	16 15	10 05	15 05	16 15	13 80	10 80	10 05
No.....	837	838	839	840	841	842	848					
Per dozen.....	\$12 05	9 55	13 80	17 15	10 80	10 80	13 65					

#### ATKINS No. 911

**"Wood-Brace"  
Frame, Double  
Rivet, No. 900  
Selected Stock  
High Finish  
Painted Red  
Jumbo Rod  
Tinned**

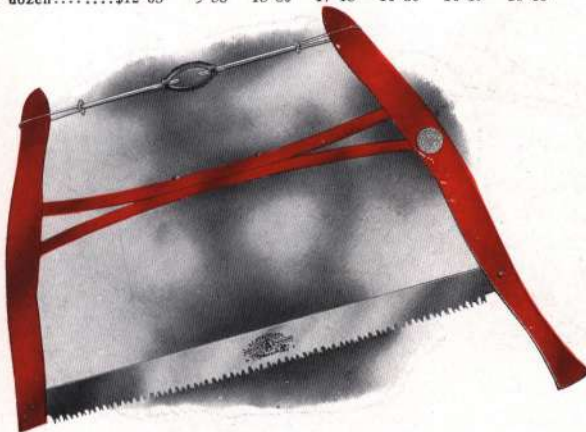

This is Atkins No. 900 Frame with No. 11 Blade (30 inches.)

List price of other combinations of No. 900 Frame with 30-inch Blades, as follows :

No.....	901	902	903	904	905	906	907	908	909	910	911	912
Per dozen.....	\$14 10	9 85	15 35	14 85	14 85	15 35	15 35	14 10	14 85	14 85	16 95	16 95
No.....	913	914	915	916	917	918	919	920	921	922	923	924
Per dozen.....	\$16 35	12 85	11 35	14 85	11 10	11 10	14 85	16 95	16 35	14 85	11 85	14 85
No.....	925	926	927	928	929	930	931	932	933	934	935	936
Per dozen.....	\$14 85	11 10	11 85	11 85	16 95	15 95	9 85	14 85	15 95	13 60	10 60	9 85
No.....	937	938	939	940	941	942	948					
Per dozen.....	\$11 85	9 35	13 60	16 95	10 60	10 60	13 45					

Above style of Frame (No. 900) with Walnut finish is W900; Mahogany finish is M900; Natural Wood finish is N900 blue (B900). In ordering, specify "Wood Saws, Complete."  
Packed half dozen in a case knocked down.

## ATKINS WOOD SAWS, COMPLETE.

### ATKINS No. 1014

**"Wood Brace" Frame  
Single Rivet, No. 1000  
Natural Wood Finish  
Clipper Tinned Rod**

This is Atkins No. 1000 Frame, with No. 14  
Blade (30 inches.)

List price of other combinations of No. 1000  
Frame (30-inch blades) as follows:

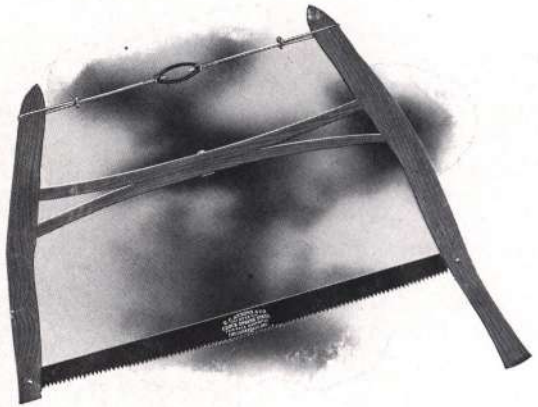

No.....	1001	1002	1003	1004	1095	1006	1007	1008	1009	1010	1011	1012
Per dozen.....	\$13 30	9 05	14 55	14 05	14 05	14 55	14 55	13 30	14 05	14 05	16 15	16 15
No.....	1013	1014	1015	1016	1017	1018	1019	1020	1021	1022	1023	1024
Per dozen.....	\$15 55	12 05	10 55	14 05	10 30	10 30	14 05	16 15	15 55	14 05	11 05	14 05
No.....	1025	1026	1027	1028	1029	1030	1031	1032	1033	1034	1035	1036
Per dozen.....	\$14 05	10 30	11 05	11 05	16 15	15 15	9 05	14 05	15 15	12 80	9 80	9 05
No.....	1037	1038	1039	1040	1041	1042	1048					
Per dozen.....	\$11 05	8 55	12 80	16 15	9 80	9 80	12 65					

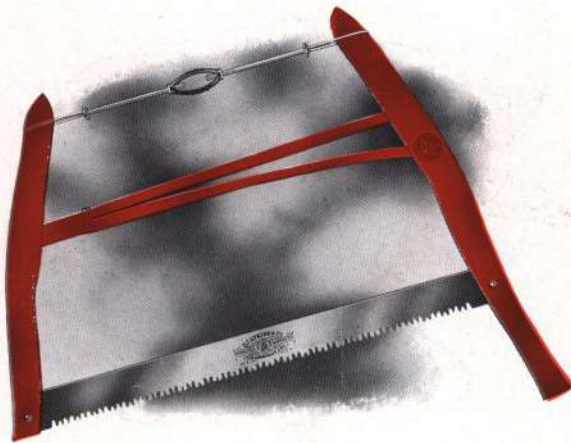

### ATKINS No. 1205

**"Happy Medium"  
Brace Frame  
Single Rivet,  
No. 1200  
Painted Red  
Jumbo Tinned Rod**

This is Atkins No. 1200 Frame with  
No. 5 Blade (30 inches.)

List price of other combinations of  
No. 1200 Frame (red) with 30-inch  
Blades as follows :

No.....	1201	1202	1203	1204	1205	1206	1207	1208	1209	1210	1211	1212
Per dozen.....	\$14 10	9 85	15 35	14 85	14 85	15 35	15 35	14 10	14 85	14 85	16 95	16 95
No.....	1213	1214	1215	1216	1217	1218	1219	1220	1221	1222	1223	1224
Per dozen.....	\$16 35	12 85	11 35	14 85	11 10	11 10	14 85	16 95	16 35	14 85	11 85	14 85
No.....	1225	1226	1227	1228	1229	1230	1231	1232	1233	1234	1235	1236
Per dozen.....	\$14 85	11 10	11 85	11 85	16 95	15 95	9 85	14 85	15 95	13 60	10 60	9 85
No.....	1237	1238	1239	1240	1241	1242	1248					
Per dozen.....	\$11 85	9 35	13 60	16 95	10 60	10 60	13 45					

In ordering, specify "Wood Saws, Complete." Packed half dozen in a case knocked down.



## ATKINS WOOD SAWS, COMPLETE.

### ATKINS No. 1313

**Extra Heavy Selected  
Seasoned Stock  
Straight Arm Pattern  
Not Painted  
Jumbo Tinned Rod**

This is Atkins No. 1300 Frame with  
No. 13 Blade (30 inches.)

List price of other combinations of  
No. 1300 Frame (30-inch Blades)  
as follows :

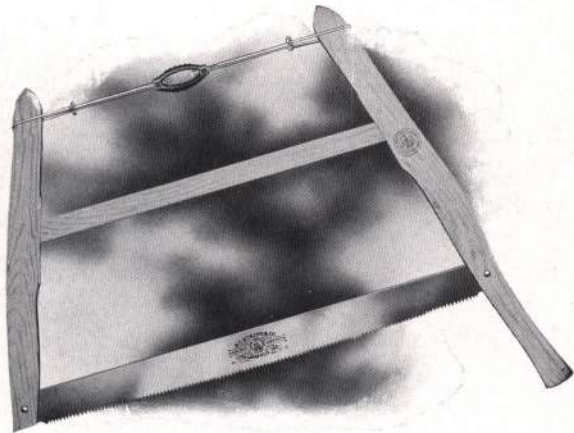

No.....	1301	1302	1303	1304	1305	1306	1307	1308	1309	1310	1311	1312
Per dozen.....	\$14 10	9 85	15 35	14 85	14 85	15 35	15 35	14 10	14 85	14 85	16 95	16 95
No.....	1313	1314	1315	1316	1317	1318	1319	1320	1321	1322	1323	1324
Per dozen.....	\$16 35	12 85	11 35	14 85	11 10	11 10	14 85	16 95	16 35	14 85	11 85	14 85
No.....	1325	1326	1327	1328	1329	1330	1331	1332	1333	1334	1335	1336
Per dozen.....	\$14 85	11 10	11 85	11 85	16 95	15 95	9 85	14 85	15 95	13 60	10 60	9 85
No.....	1337	1338	1339	1340	1341	1342	1348					
Per dozen.....	\$11 85	9 35	13 60	16 95	10 60	10 60	13 45					

### ATKINS No. 1429

**Second Growth  
Hickory  
"Wood-Brace"  
Frame  
Double Rivet  
Fine Natural  
Finish  
Jumbo Tinned Rod**

This is Atkins No. 1400 Frame, with  
No. 29 Blade (30 inches.)

List price of other combinations of  
No. 1400 Frame (30-inch  
Blades) as follows :

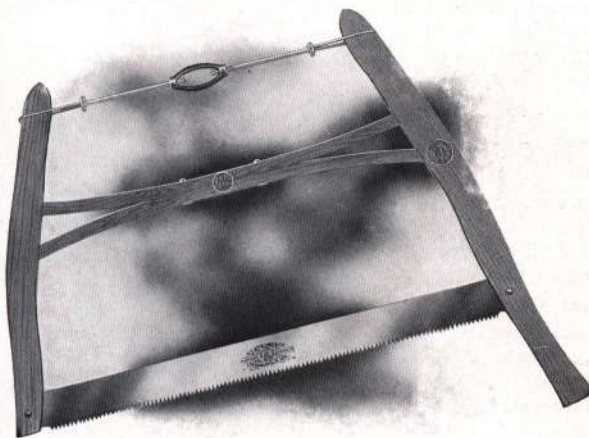

### The Most Substantial and Strongest Frame Made

No.....	1401	1402	1403	1404	1405	1406	1407	1408	1409	1410	1411	1412
Per dozen.....	\$14 70	10 45	15 95	15 45	15 45	15 95	15 95	14 70	15 45	15 45	17 55	17 55
No.....	1413	1414	1415	1416	1417	1418	1419	1420	1421	1422	1423	1424
Per dozen.....	\$16 95	13 45	11 95	15 45	11 70	11 70	14 45	17 55	16 95	15 45	12 45	15 45
No.....	1425	1426	1427	1428	1429	1430	1431	1432	1433	1434	1435	1436
Per dozen.....	\$15 45	11 70	12 45	12 45	17 55	16 55	10 45	15 45	16 55	14 20	11 20	10 45
No.....	1437	1438	1439	1440	1441	1442	1448					
Per dozen.....	\$12 45	9 95	14 20	17 55	11 20	11 20	14 05					

In ordering, specify "Wood Saws, Complete." Packed half dozen in a case knocked down.



## ATKINS WOOD SAWS, COMPLETE.

### ATKINS No. 1509

**Designed for Sawing  
Extra Large Logs.**

**Notice the Shape of  
the Brace, which  
Permits Use in  
Heavy Timber.**

**Frame of Selected  
Hard Maple,  
Malleable Casting,  
Jumbo Tinned Rod.**

This is Atkins No. 1500 Frame with  
No. 9 Blade.

List prices of other combinations of  
No. 1500 Frame (30-inch Blades)  
as follows:

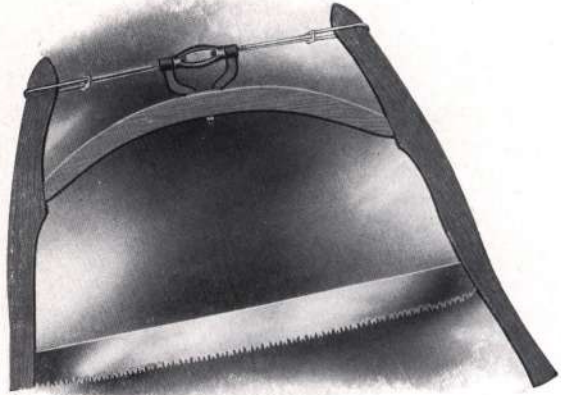

No.....	1501	1502	1503	1504	1505	1506	1507	1508	1509	1510	1511	1512
Per dozen.....	\$15 95	11 70	17 20	16 70	16 70	17 20	17 20	15 95	16 70	16 70	18 80	18 80
No.....	1513	1514	1515	1516	1517	1518	1519	1520	1521	1522	1523	1524
Per dozen.....	\$18 20	14 70	13 20	16 70	12 95	12 95	16 70	18 80	18 20	16 70	13 70	16 70
No.....	1525	1526	1527	1528	1529	1530	1531	1532	1533	1534	1535	1536
Per dozen.....	\$16 70	12 95	13 70	13 70	18 80	17 80	11 70	16 70	17 80	15 45	12 45	11 70
No.....	1537	1538	1539	1540	1541	1542	1548					
Per dozen.....	\$13 70	11 20	15 45	18 80	12 45	12 45	15 30					

### ATKINS No. 1600 FRAME.

**Second Growth Hickory.**

**This Frame is of the Same Pattern as No. 1500, but is Furnished  
in Extra Fine Quality of Seasoned Hickory instead of  
Maple, and is Finished either a Beautiful  
Malachite Green or Varnished  
Natural.**

No. 1600 Frame furnished in combination with any 30-inch Blade at the following list prices.

No.....	1601	1602	1603	1604	1605	1606	1607	1608	1609	1610	1611	1612
Per dozen.....	\$16 85	12 60	18 10	17 60	17 60	18 10	18 10	16 85	17 60	17 60	19 70	19 70
No.....	1613	1614	1615	1616	1617	1618	1619	1620	1621	1622	1623	1624
Per dozen.....	\$19 10	15 60	14 10	17 60	13 85	13 85	17 60	19 70	19 10	17 60	14 60	17 60
No.....	1625	1626	1627	1628	1629	1630	1631	1632	1633	1634	1635	1636
Per dozen.....	\$17 60	13 85	14 60	14 60	19 70	18 70	12 60	17 60	18 70	16 35	13 35	12 60
No.....	1637	1638	1639	1640	1641	1642	1648					
Per dozen.....	\$14 60	12 10	16 35	19 70	13 35	13 35	16 20					

In ordering, specify "Wood Saws Complete." Packed one-half dozen in a case knocked down.

**ATKINS WOOD SAW FRAMES ONLY (Knocked Down)**

**SINGLE BRACE FRAME.**



No. 100.	Atkins "Special" painted red.....	Long Arm	\$13 50	Short Arm	\$12 50	Brace	\$11 00	Complete without rods in half gross crates	\$37 00	Complete without rods in half doz. boxes	\$42 00
No. 200.	Atkins O. K., not painted.....	.....	10 00	.....	9 25	.....	8 25	.....	27 50	.....	32 50
No. 300.	Atkins O. K., painted red.....	.....	13 00	.....	12 00	.....	10 00	.....	35 00	.....	40 00
No. 1300.	Extra Heavy, not painted.....	.....	16 00	.....	13 50	.....	13 00	.....	42 50	.....	47 50

**DOUBLE BRACE FRAME.**

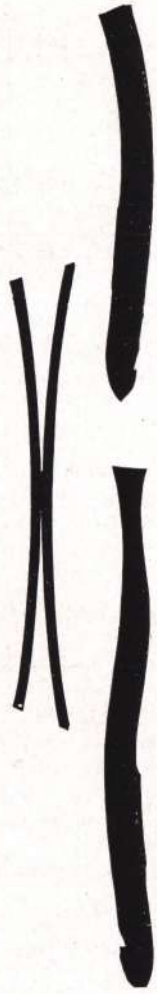

No. 500.	Atkins Extra painted red, Single Rivet.....	\$14 00	\$12 50	\$13 00	\$39 50	\$44 50
No. 600.	Wood Brace, painted red, Single Rivet.....	13 50	12 00	12 00	37 50	42 50
No. 700.	Fine Natural Wood Finish, Single Rivet.....	14 00	12 50	13 00	39 50	44 50
No. 800.	Cantilever Natural Finish.....	16 00	14 50	14 50	45 00	50 00
No. 900.	Any color. (See note.) Double rivet.....	15 50	13 00	14 00	42 50	47 50
No. 1000.	Natural Wood Finish, Single Rivet.....	13 50	12 00	12 00	37 50	42 50
No. 1200.	Happy Medium, painted red, Single Rivet.....	15 50	13 00	14 00	42 50	47 50
No. 1400.	Old Hickory, not painted, Double Rivet.....	18 00	16 00	16 00	50 00	55 00
No. 1500.	Maple, painted red.....	21 50	18 50	25 00	65 00	70 00
No. 1600.	Hickory, finished green or varnished.....	24 50	22 00	29 00	75 50	80 50

Wood Saw parts when ordered separate will be packed in bulk.

NOTE.—No. 900 furnished in Blue will be designated as B900; if in Walnut as W900; Mahogany as M900; Natural as N900.



## ATKINS CELEBRATED WOOD SAW BLADES. CLASS "A"

**Etched E. C. Atkins & Co. SILVER-STEEL, Extra Thin Back, Extra Polish, Special Hand Filed. THE FINEST BLADE MADE.**

No.	Style of Tooth.	Breasted or Straight on Tooth Edge.	Width, Inches.	Finish.	List, 30-inch.
3	Plain	Straight	1 $\frac{3}{4}$	Bright	\$10 00
13	"	Breasted	2 $\frac{3}{8}$	"	11 00
21	"	Straight	2 $\frac{3}{8}$	"	11 00
6	Tuttle	"	1 $\frac{3}{4}$	"	10 00
11	"	Breasted	2 $\frac{3}{8}$	"	11 60
7	Diamond	Straight	1 $\frac{3}{4}$	"	10 00
12	"	Breasted	2 $\frac{3}{8}$	"	11 60
30	Peg	Straight	1 $\frac{3}{4}$	"	10 60
33	"	Breasted	1 $\frac{3}{4}$	Blued	10 60
29	"	Straight	2 $\frac{3}{8}$	Bright	11 60
20	"	Breasted	2 $\frac{3}{8}$	"	11 60
40	Universal	"	2 $\frac{3}{8}$	"	11 60

### CLASS "B"

**Etched E. C. Atkins & Co. SILVER-STEEL, Special Thin Back. Fine Polish, Hand Filed.**

15	Plain	Straight	1 $\frac{1}{4}$	Blued	\$6 00
14	"	Breasted	1 $\frac{3}{4}$	"	7 50
1	"	Straight	2 $\frac{3}{8}$	Bright	8 75
8	"	Breasted	2 $\frac{3}{8}$	"	8 75
4	Tuttle	Straight	2 $\frac{3}{8}$	"	9 50
9	"	Breasted	2 $\frac{3}{8}$	"	9 50
22	Wide Raker	"	2 $\frac{3}{8}$	"	9 50
5	Diamond	Straight	2 $\frac{3}{8}$	"	9 50
10	"	Breasted	2 $\frac{3}{8}$	"	9 50
19	Peg	"	2 $\frac{3}{8}$	"	9 50
34	"	"	1 $\frac{3}{4}$	Blued	8 25
16	Needle Point	"	2 $\frac{3}{8}$	Bright	9 50
24	Matchless	"	2 $\frac{3}{8}$	"	9 50
25	Lightning	Straight	2 $\frac{3}{8}$	"	9 50
32	Universal	Breasted	2 $\frac{3}{8}$	"	9 50
39	Tuttle	Straight	1 $\frac{3}{4}$	"	8 25

### CLASS "C"

**Etched Sheffield Saw Works. Best Tool Steel. Thin Back.**

36	Plain	Straight	1 $\frac{1}{4}$	Blued	\$4 50
18	"	Breasted	1 $\frac{3}{4}$	"	5 75
17	"	"	2 $\frac{1}{4}$	Bright	5 75
26	"	Straight	2 $\frac{1}{4}$	"	5 75
23	Tuttle	Breasted	2 $\frac{1}{4}$	"	6 50
37	Large Tuttle	Straight	2 $\frac{1}{4}$	"	6 50
28	Peg	Breasted	1 $\frac{3}{4}$	Blued	6 50
27	"	"	2 $\frac{1}{4}$	Bright	6 50
48	Universal	"	2 $\frac{1}{4}$	"	8 10

### CLASS "D"

**Special Steel. Flat Ground.**

38	Plain	Straight	1 $\frac{1}{4}$	Bright	\$4 00
2	"	"	2	"	4 50
31	"	Breasted	2	"	4 50
35	Peg	"	2	"	5 25
41	"	Straight	2	"	5 25
42	Tuttle	"	2	"	5 25

**Prices on blades longer than 30 inches will be quoted on application.**



## ATKINS POPULAR WOOD SAW BLADES.

(See other styles in frames shown on preceding pages.)

No. 4. Tuttle Tooth. (Straight, 2 $\frac{3}{8}$  inches wide.)

No. 5. Diamond Tooth. (Straight, 2 $\frac{3}{8}$  inches wide.)

No. 10. Diamond Tooth. (Breasted, 2 $\frac{3}{8}$  inches wide.)

No. 15. Plain Tooth. (Straight, 1 $\frac{1}{2}$  inches wide.)

No. 16. Needle Point Tooth. (Breasted, 2 $\frac{3}{8}$  inches wide.)

No. 19. Peg Tooth. (Breasted, 2 $\frac{3}{8}$  inches wide.)

No. 22. Tuttle Tooth (wide raker). (Breasted, 2 $\frac{3}{8}$  inches wide.)

No. 23. Tuttle Tooth. (Breasted, 2 $\frac{1}{4}$  inches wide.)

No. 24. Matchless Tooth. (Breasted, 2 $\frac{3}{8}$  inches wide.)

No. 25. Lightning Tooth. (Straight, 2 $\frac{3}{8}$  inches wide.)

No. 29. Peg Tooth. (Straight, 2 $\frac{3}{8}$  inches wide.)

No. 40. Improved Universal. (Straight, 2 $\frac{3}{8}$  inches wide.)

No. 41. Peg Tooth. (Straight, 2 inches wide.)

No. 42. Tuttle Tooth. (Straight, 2 inches wide.)

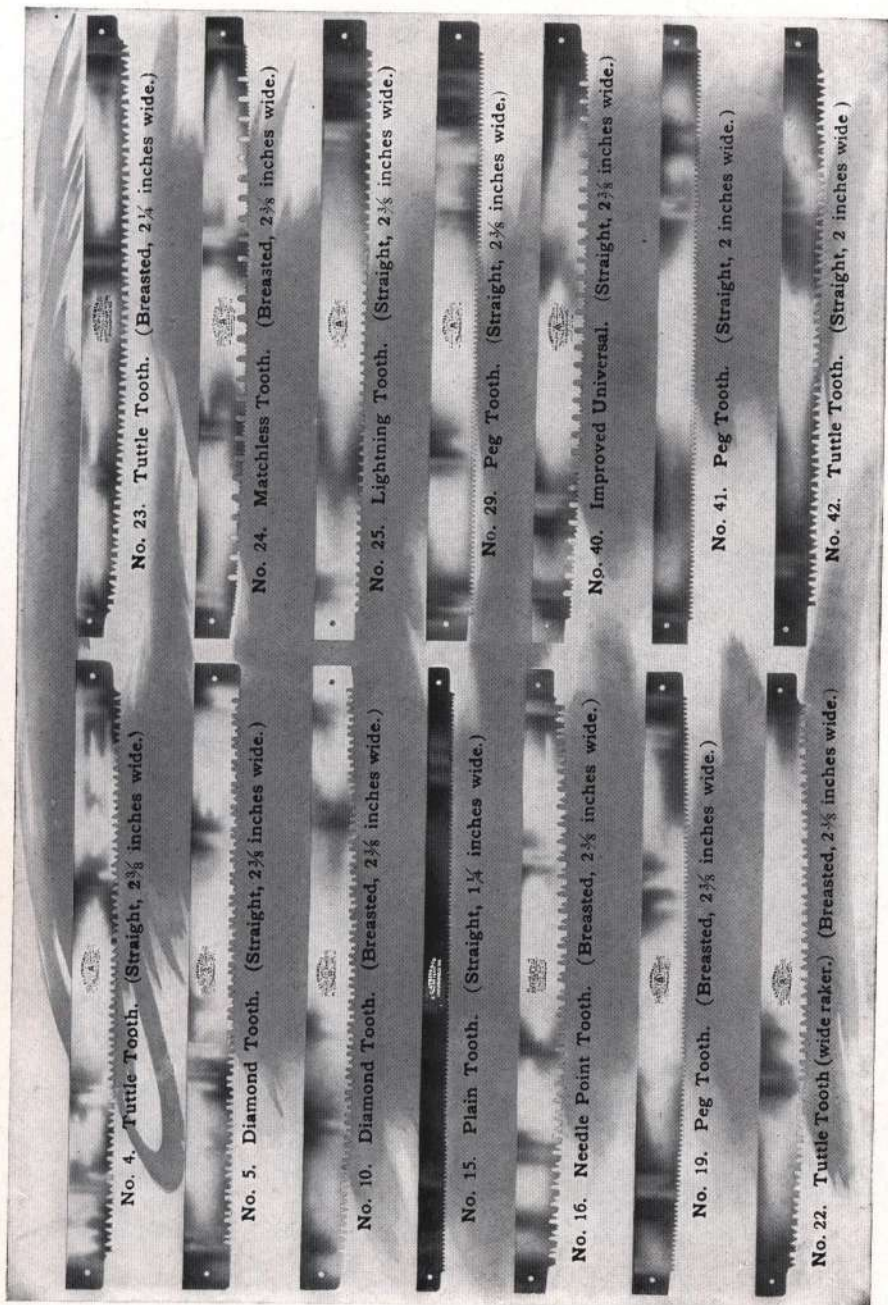

## Atkins Hand, Panel and Rip Saws

The wonderful growth of our business in hand and small saws has been noted and remarked upon from all quarters. The secret of our success in this Department is on account of the high quality of the saws.

This quality is based upon the use of our celebrated SILVER-STEEL which enables the saw to take a high, tough temper, which, together with the finest grade of grinding, finish and workmanship throughout, makes them the finest saws on the market.

The following numbers are our leaders :

- Nos. 51, 54, 55. SILVER-STEEL, Damaskeen finish.
- Nos. 53 and 65. SILVER-STEEL, Perfection handle, Damaskeen finish.
- Nos. 66 and 67. SILVER-STEEL, Mirror finish.
- Nos. 68 and 69. SILVER-STEEL, Perfection handle, Mirror finish.
- No. 64. SILVER NICKEL STEEL, London spring, Damaskeen finish.
- No. 52. SILVER-STEEL, Damaskeen ; made especially for pattern and bench work, to run without set.

We wish to call your particular attention to the Numbers 400 and 401 Hand, Rip and Panel Saws. These are unquestionably the Finest Saws ever made for the regular trade. Nothing has been spared that may add in any way to Quality of Material, Construction or Finish.

We also manufacture a full line of medium-priced Hand Saws, which are equal in quality to any Saws not branded "ATKINS."



## NUMBER OF POINTS PER INCH IN SAWS.

The following cuts are full size and represent number of points per inch in saws, also the various styles of teeth most commonly used. Care should be taken when ordering to specify points per inch, as there is one less tooth per inch than there are points.

4 Points per inch.  
(Rip.)



4½ Points per inch.  
(Rip.)



5 Points per inch.



5½ Points per inch.



6 Points per inch.



7 Points per inch.

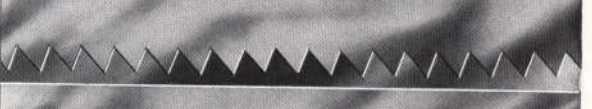

8 Points per inch.

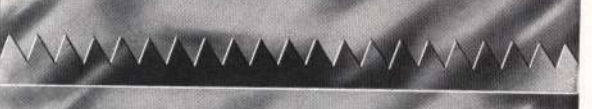

9 Points per inch.



10 Points per inch.

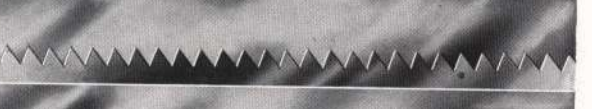

11 Points per inch.



12 Points per inch.

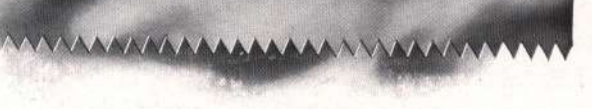



**ATKINS HAND, PANEL AND RIP SAWS.**

**SILVER-STEEL.  
MIRROR FINISH.**



**No. 400. THE ELITE SAW.**

**The Finest and Most Expensive Hand Saw Ever Made.**

Silver-Steel, Skew-Back, Mirror Finish. Rosewood or South American Vermillion Handle, Perfection Pattern, Polished, with four Silver Plated Screws.

Inches .....	16	18	20	22	24	26	28	30
Per dozen .....	\$33 00	36 00	39 00	42 00	45 00	48 00	55 00	61 00



**No. 401. THE ELITE SAW.**

Silver-Steel, Straight-Back, Mirror Finish. Rosewood or South American Vermillion Handle, Perfection Pattern, Polished, with four Silver Plated Screws.

Inches .....	16	18	20	22	24	26	28	30
Per dozen .....	\$33 00	36 00	39 00	42 00	45 00	48 00	55 00	61 00

Above packed one in a box.

**ATKINS HAND, PANEL AND RIP SAWS.**

**SILVER-STEEL, WARRANTED,  
DAMASKEENED.**



**No. 51. RIP SAW.**

Silver-Steel, Skew-Back, Apple Handle, Polished Edge.

Inches .....	28	30	32
Per dozen .....	\$27 75	31 00	35 00



**No. 51. HAND SAW.**

Silver-Steel, Skew-Back, Apple Handle, Polished Edge.

Inches .....	26
Per dozen .....	\$24 50



**No. 51. PANEL SAW.**

Silver-Steel, Skew-Back, Apple Handle, Polished Edge.

Inches .....	16	18	20	22	24
Per dozen .....	\$16 00	17 75	19 50	21 75	23 50

Put up one-third dozen in a box.

— ATKINS SILVER STEEL SAWS —

**ATKINS HAND, PANEL AND RIP SAWS.**

**SILVER-STEEL, WARRANTED.  
POLISHED FINISH.**



**No. 52. RIP SAW.**

Silver-Steel, Skew-Back, Carved and Polished Apple Handle.

Inches .....	28	30
Per dozen .....	\$39 25	43 75

Use for filing this saw 6-inch safe-back cant file.



**No. 52. HAND SAW.**

Silver-Steel, Skew-Back, Carved and Polished Apple Handle.

Inches .....	26
Per dozen .....	\$35 00

Use for filing this saw 6-inch safe-back cant file.



**No. 52. PANEL SAW.**

Silver-Steel, Skew-Back, Carved and Polished Apple Handle.

Inches .....	16	18	20	22	24
Per dozen .....	\$24 00	26 25	28 50	31 75	34 00

Use for filing this saw 6-inch safe-back cant file.

Put up one-third dozen in a box.



**ATKINS HAND, PANEL AND RIP SAWS.**  
**SILVER-STEEL, WARRANTED.**  
**DAMASKEENED.**



**No. 53. RIP SAW.**

Silver-Steel, Skew-Back, Carved and Polished Apple Handle, Atkins Perfection Style.

Inches.....	28	30
Per dozen .....	\$28 75	32 50



**No. 53. HAND SAW.**

Silver-Steel, Skew-Back, Carved and Polished Apple Handle, Atkins Perfection Style.

Inches .....	26
Per dozen.....	\$25 50



**No. 53. PANEL SAW.**

Silver-Steel, Skew-Back, Carved and Polished Apple Handle, Atkins Perfection Style.

Inches .....	16	18	20	22	24
Per dozen.....	\$16 75	18 50	20 50	22 50	24 50

Put up one-third dozen in a box.

**ATKINS HAND, PANEL AND RIP SAWS.**

**SILVER-STEEL, WARRANTED.  
DAMASKEENED.**



**No. 54. RIP SAW.**

Silver-Steel, Beech Handle, Polished Edge.

Inches .....	28	30	32	34	36
Per dozen .....	\$23 25	27 00	30 25	34 50	38 75



**No. 54. HAND SAW.**

Silver-Steel, Beech Handle, Polished Edge.

Inches .....	26
Per dozen .....	\$20 00



**No. 54. PANEL SAW.**

Silver-Steel, Beech Handle, Polished Edge.

Inches .....	12	14	16	18	20	22	24
Per dozen .....	\$12 00	12 00	13 00	14 00	16 00	18 00	19 00

Put up one-third dozen in a box.

**ATKINS HAND, PANEL AND RIP SAWS.**

**SILVER-STEEL, WARRANTED.  
DAMASKEENED.**



**No. 55. RIP SAW.**

Silver-Steel, Apple Handle, Polished Edge.

Inches .....	28	30
Per dozen.....	\$26 75	31 00



**No. 55. HAND SAW.**

Silver-Steel, Apple Handle, Polished Edge.

Inches .....	26
Per dozen .....	\$23 00



**No. 55. PANEL SAW.**

Silver-Steel, Apple Handle, Polished Edge.

Inches .....	16	18	20	22	24
Per dozen .....	\$14 50	16 00	18 00	19 50	21 50

Put up one-third dozen in a box.



ATKINS SILVER STEEL SAWS

**ATKINS HAND, PANEL AND RIP SAWS.**

LONDON SPRING, SILVER NICKEL STEEL.

DAMASKEENED.



**No. 64. RIP SAW.**

London Spring, Silver Nickel Steel, Carved and Polished Apple Handle.

Inches .....	28	30	32
Per dozen .....	\$35 00	41 00	47 50



**No. 64. HAND SAW.**

London Spring, Silver Nickel Steel, Carved and Polished Apple Handle.

Inches .....	26
Per dozen .....	\$30 00



**No. 64. PANEL SAW.**

London Spring, Silver Nickel Steel, Carved and Polished Apple Handle.

Inches .....	16	18	20	22	24
Per dozen .....	\$18 75	21 00	23 50	26 00	28 50

Put up one-third dozen in a box.

**ATKINS HAND, PANEL AND RIP SAWS.**  
**SILVER-STEEL, WARRANTED.**  
**DAMASKEENED.**



**No. 65. RIP SAW.**

Silver-Steel, Carved and Polished Apple Handle. With the Atkins Perfection Handle.

Inches .....	28	30
Per dozen .....	\$28 75	32 50



**No. 65. HAND SAW.**

Silver-Steel, Carved and Polished Apple Handle. With the Atkins Perfection Handle.

Inches .....	26
Per dozen .....	\$24 50



**No. 65. PANEL SAW.**

Silver-Steel, Carved and Polished Apple Handle. With the Atkins Perfection Handle.

Inches .....	16	18	20	22	24
Per dozen .....	\$16 00	17 50	19 50	21 00	23 00

Put up one-third dozen in a box.

**ATKINS HAND, PANEL AND RIP SAWS.**

**SILVER-STEEL, WARRANTED, MIRROR FINISH.**



**No. 66. RIP SAW.**

Silver-Steel, Skew-Back, Apple Handle, Polished Edge, Mirror Finish.

Inches .....	28	30	32
Per dozen.....	\$31 00	36 00	42 00



**No. 66. HAND SAW.**

Silver-Steel, Skew-Back, Apple Handle, Polished Edge, Mirror Finish.

Inches .....	26
Per dozen.....	\$27 00



**No. 66. PANEL SAW.**

Silver-Steel, Skew-Back, Apple Handle, Polished Edge, Mirror Finish.

Inches .....	16	18	20	22	24
Per dozen.....	\$17 00	19 00	21 00	23 00	25 00

Put up one-third dozen in a box.



**ATKINS HAND, PANEL AND RIP SAWS.**

**SILVER-STEEL, WARRANTED.  
MIRROR FINISH.**



**No. 67. RIP SAW.**

Silver-Steel, Straight-Back, Apple Handle, Polished Edge, Mirror Finish.

Inches .....	28	30	32
Per dozen.....	\$30 00	35 00	41 00



**No. 67. HAND SAW.**

Silver-Steel, Straight-Back, Apple Handle, Polished Edge, Mirror Finish.

Inches .....	26
Per dozen.....	\$26 00



**No. 67. PANEL SAW.**

Silver-Steel, Straight-Back, Apple Handle, Polished Edge, Mirror Finish.

Inches.....	16	18	20	22	24
Per dozen.....	\$16 00	18 00	20 00	22 00	24 00

Put up one-third dozen in a box.

## ATKINS HAND, PANEL AND RIP SAWS.

**SILVER-STEEL.**

**MIRROR FINISH.**



### No. 68.

Skew-Back, Silver-Steel, Mirror Finish, Perfection Carved Apple Handle,  
Polished Edge.

Inches.....	16	18	20	22	24	26	28	30	32
Per dozen.....	\$17 50	19 50	21 50	23 50	25 50	27 50	31 50	36 50	42 50



### No. 69.

Straight-Back, Silver-Steel, Mirror Finish, Perfection Carved Apple Handle,  
Polished Edge.

Inches.....	16	18	20	22	24	26	28	30	32
Per dozen.....	\$16 50	18 50	20 50	22 50	24 50	26 50	30 50	35 50	41 50

Put up one-third dozen in a box.

**ATKINS MATCHLESS AND UNIVERSAL  
HAND SAWS.**



**Specially adapted for Cross Cutting, Mitreing and Ripping.**

**No. 73 MATCHLESS.**

**No. 83 UNIVERSAL.**

Silver-Steel, Skew-Back, Carved and Polished Apple Handle. Damaskeened.

Inches .....	16	18	20	22	24	26	28	30	32
Per dozen.....	\$29 50	30 50	31 50	33 00	34 50	36 00	40 00	44 00	48 00

**No. 74 MATCHLESS.**

**No. 84 UNIVERSAL.**

Silver-Steel, Straight-Back, Beech Handle, Polished Edge. Damaskeened.

Inches .....	16	18	20	22	24	26	28	30	32
Per dozen.....	\$25 50	26 50	27 50	28 50	30 00	31 50	34 00	37 50	41 50

**No. 76 MATCHLESS.**

**No. 86 UNIVERSAL.**

Sheffield Saw Works, Special Steel, Warranted, Skew-Back, Carved and Polished Apple Handle.

Inches .....	16	18	20	22	24	26	28	30	32
Per dozen.....	\$21 00	22 00	23 00	24 00	25 00	26 50	29 50	32 50	36 50

Put up one-third dozen in a box.

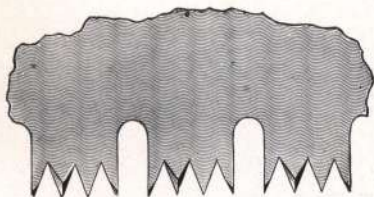

Section of Matchless Hand Saw. Full Size.

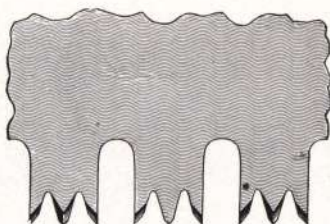

Section of Universal Hand Saw. Full Size.



## ATKINS IMPROVED UNIVERSAL HAND SAW.



These Saws are absolutely guaranteed to cut faster and easier, in soft or hard wood, in either ripping, mitre or cross-cutting, than any other saw especially fitted for one purpose.

### No. 93.

Silver-Steel, Damaskeened Finish, Skew-Back, Carved and Polished Apple Handle.

Inches .....	16	18	20	22	24	26	28	30	32
Per dozen.....	\$29 50	30 50	31 50	33 00	34 50	36 00	40 00	44 00	48 00

### No. 94.

Silver-Steel, Damaskeened Finish, Straight-Back, Polished Apple Handle.

Inches .....	16	18	20	22	24	26	28	30	32
Per dozen.....	\$25 50	26 50	27 50	28 50	30 00	31 50	34 00	37 50	41 50

### No. 96.

Sheffield Saw Works, Special Steel, Polished Finish, Warranted, Skew-Back, Carved and Polished Apple Handle.

Inches .....	16	18	20	22	24	26	28	30	32
Per dozen.....	\$21 00	22 00	23 00	24 00	25 00	26 50	29 50	32 50	36 50

### No. 99.

Sheffield Saw Works, Cast Steel, Skew-Back, Beech Handle, Polished Edge.

Inches .....	16	18	20	22	24	26	28	30	32
Per dozen.....	\$17 50	18 25	19 00	19 75	20 50	21 50	24 00	27 00	30 00

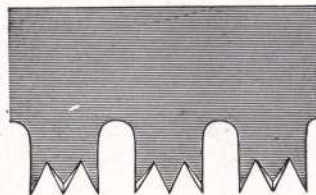

Full Sized Section, Showing Construction of Tooth.

**ATKINS HAND, PANEL AND RIP SAWS.**

**SILVER-STEEL, WARRANTED.  
DAMASKEENED.**



**No. 61. HAND SAW.**

Silver-Steel, Warranted, Combined Rule and Square, Carved Apple Handle.

We will furnish this saw, when so ordered, with a brass plate on the straight edge of the handle, to prevent wear, at additional price of \$3.00 per dozen list.

Inches .....	26
Per dozen, with plate.....	\$29 00
Per dozen, without plate.....	26 00

**OUR LEADING NARROW PATTERN.**



**No. 72.**

Silver-Steel, Damasked, Carved Apple Handle.

The 26-inch Blades are  $5\frac{1}{4}$  inches wide at the butt, and  $1\frac{1}{8}$  inches wide at the point. Other lengths are proportionate widths.

Inches .....	16	18	20	22	24	26	28	30
Per dozen.....	\$16 00	17 50	19 50	21 00	23 00	24 50	28 75	32 50

Above put up one-third dozen in a box.

## ATKINS HAND, PANEL AND RIP SAWS.

**SHIP CARPENTER'S. SILVER-STEEL, WARRANTED.**



### No. 53.

Silver-Steel, Skew-Back, Damaskeened, Carved and Polished Apple Handle, Perfection Pattern.

Inches .....	16	18	20	22	24	26	28
Per dozen.....	\$16 75	18 50	20 50	22 50	24 50	25 50	28 75



### No. 65.

Silver-Steel, Damaskeened, Carved and Polished Apple Handle, Perfection Pattern.

Inches .....	16	18	20	22	24	26	28
Per dozen.....	\$16 00	17 50	19 50	21 00	23 00	24 50	28 75



### No. 54.

Silver-Steel, Damaskeened, Beech Handle, Polished Edge.

Inches .....	14	16	18	20	22	24	26	28
Per dozen.....	\$12 00	13 00	14 00	16 00	18 00	19 00	20 00	23 25

Ship Point Saws will be made in any quality of Atkins Brand at their respective prices.

Put up one-third dozen in a box.



**ATKINS HAND, PANEL AND RIP SAWS.**

**ATKINS SPECIAL STEEL.**

**Next to our Silver-Steel Saws, the Finest Saws Made in the World.**



**No. 70.**

Special Steel, Apple Handle, Polished Edge, Blade Highly Finished, Skew-Back.

Inches ...	12	14	16	18	20	22	24	26	Rip. 28	Rip. 30
Per dozen.	\$11 50	12 25	13 50	15 00	16 50	18 00	19 50	21 00	25 00	29 00



**No. 71.**

Special Steel, Beech Handle, Polished Edge, Blade Highly Finished, Straight-Back.

Inches ...	12	14	16	18	20	22	24	26	Rip. 28	Rip. 30
Per dozen.	\$10 50	11 50	12 25	13 50	15 00	16 50	17 50	18 25	21 25	24 50

Put up one-third dozen in a box.

## ATKINS HAND, PANEL AND RIP SAWS.

**SHEFFIELD SAW WORKS LINE.**

**Superior to any Saw that is Not Etched "Atkins."**



### No. 56. SUPERIOR SAW.

Sheffield Saw Works, Special Steel, Warranted, Skew-Back,  
Carved and Polished Handle.

Inches .....	14	16	18	20	22	24	26	Rip 28	Rip 30
Per dozen .....	\$11 75	12 25	12 75	13 25	14 00	14 75	17 75	19 25	21 25

Put up one-third dozen in a box.



### No. 57. STANDARD SAW.

Sheffield Saw Works, Special Steel, Beech Handle.

Inches .....	14	16	18	20	22	24	26	28
Per dozen .....	\$5 75	6 00	6 50	7 00	7 50	8 00	9 00	10 50

Put up one-half dozen in a box.

ATKINS HAND, PANEL AND RIP SAWS.

SHEFFIELD SAW WORKS LINE.

CAST STEEL, WARRANTED.



No. 58. RELIABLE SAW.

Sheffield Saw Works, Cast Steel, Warranted, Beech Handle, Polished Edge.

Inches .....	14	16	18	20	22	24	26	Rip. 28
Per dozen .....	\$7 25	8 25	9 25	10 50	11 50	12 50	13 50	16 00

Put up one-third dozen in a box.



No. 59. RELIABLE SAW.

Sheffield Saw Works, Cast Steel, Warranted, Skew-Back, Beech Handle, Polished Edge.

Inches .....	14	16	18	20	22	24	26	Rip. 28
Per dozen .....	\$9 50	10 00	10 75	11 50	12 25	13 00	14 00	16 00

Put up one-third dozen in a box.



**ATKINS HAND, PANEL AND RIP SAWS.**  
**SHEFFIELD SAW WORKS LINE.**



**No. 60. HAND SAW.**

Sheffield Saw Works, Special Steel, Combined Rule and Square, Beech Handle.

Inches .....	26
Per dozen .....	\$9 00



**No. 62. CHIEF.**

Sheffield Saw Works, Special Steel, Beech Handle.

Inches .....	14	16	18	20	22	24	26	Rip.
Per dozen .....	\$5 00	5 25	5 50	6 00	6 50	7 00	7 50	28
								8 50

Put up one-half dozen in a box.

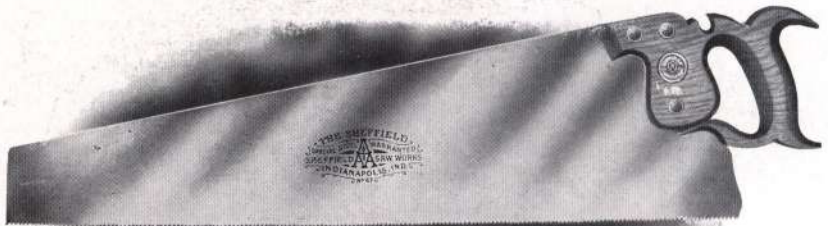

**No. 63 SAW.**

Sheffield Saw Works, Special Steel, Warranted, Beech Handle.

Inches .	14	16	18	20	22	24	26	Rip.	Rip.	Rip.
Per doz.	\$9 50	10 50	11 50	13 00	14 50	16 00	17 25	21 00	24 00	27 00
								28	30	32

Put up one-third dozen in a box.

ATKINS HAND, PANEL AND RIP SAWS.

SHEFFIELD SAW WORKS LINE.

BLUED SAWS.



No. 156 SAW.

Sheffield Saw Works, Special Steel, Warranted, Skew-Back, Carved and Polished Handle.



No. 159 SAW.

Sheffield Saw Works, Cast Steel, Warranted, Skew-Back, Beech Handle, Polished Edge.

Put up one-third dozen in a box.

Other patterns of Blued Saws are furnished when desired. Prices on application.

## ATKINS MANUAL TRAINING SCHOOL SAWS.

We make a specialty of equipping Manual Training Schools with Hand, Panel, Rip, Back, Mitre, Coping, Compass, Keyhole, in fact a complete line of Saws, for all purposes. We recommend particularly our High Grade SILVER-STEEL on account of its edge-holding qualities, and wish to call special attention to the scientific construction of our Saws.

We appreciate the necessity of supplying the younger generation with strictly High-Grade Tools, and our Manual Training Saws are made with this idea in view.

We show below two of the most popular patterns of Hand Saws, and should be pleased to correspond with any institution which is contemplating the installation of a new equipment.



This Saw is made of SILVER-STEEL, Skew Back, and the blade is ground on an actual taper from the tooth edge toward the point on the back (which is the thinnest part) so as to give clearance. Extra high damaskeened finish, Perfection Pattern Handle, made of apple-wood, carved and polished.



This Saw Blade is made of SILVER-STEEL, Skew Back, and taper ground, similar to the previous Saw, Damaskeened Finish, Apple Handle of different pattern from above.

## BACK SAWS.

Our special Manual Training School Back Saw is similar in style to our No. 2, shown on the following page, but is specially designed for Manual Training purposes.

Write for detailed information in regard to other types of Manual Training School Saws.



**ATKINS MITRE BOX SAWS.**



**No. 1.**

Silver-Steel, Apple Handle, Polished Edge.

Four inches under back.

Inches .....	18	20	22	24	26	28	30	32
Per dozen.....	\$25 25	27 50	29 75	32 00	34 25	36 50	38 75	41 00

Five inches under back.

Inches.....	22	24	26	28	30	32
Per dozen .....	\$32 00	35 00	38 00	41 00	44 00	47 00

Six inches under back.

Inches.....	22	24	26	28	30	32
Per dozen .....	\$35 50	39 00	42 50	46 00	49 50	53 00

**BACK SAWS.**

**E. C. ATKINS & CO.'S SILVER-STEEL.**



**No. 2.**

Silver-Steel, Apple Handle.

Inches.....	8	10	12	14	16	18
Per Dozen.....	\$15 00	16 00	18 00	20 00	22 50	25 00

**SHEFFIELD SAW WORKS.**



**No. 3.**

Standard Cast Steel, Beech Handle.

Inches .....	8	10	12	14	16	18	20	22	24
Per Dozen.....	\$10 25	11 50	13 50	15 75	18 00	20 25	22 75	25 25	27 75

All above put up one-third dozen in a box.

## ATKINS PERFECTION GRASS HOOK.

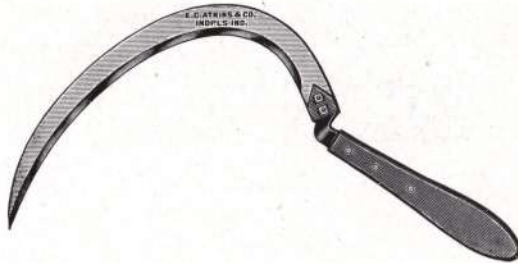

The above specialty will be thoroughly appreciated by all users of Grass Hooks. The Hooks are meeting with an extra demand wherever shown.

The Blade is of Silver-Steel and will hold its edge much longer than the material usually placed in similar tools. It is extremely light and does not tire the wrist. Fitted with a hardwood, easy grip handle, securely fastened to a malleable casting by strong rivets. The curve of the blade is such that the entire cutting edge is constantly in use. Corners and out of the way spots may be easily reached.

**The handle being offset, saves the knuckles from becoming bruised.**

List price, per dozen, \$8.00.

## PATTERN MAKERS' SAW.

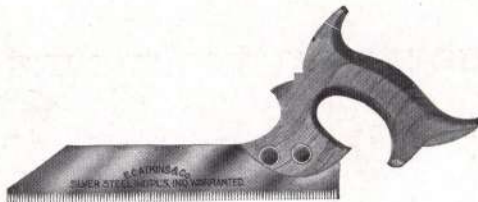

This Saw is designed for very fine smooth work. The Blade is  $7\frac{1}{2}$  inches long and there are 14 sharp, pointed teeth to the inch. The Handle is of sanded apple wood. Two brass screws.

Packed one in a box with label on top and end.

List price, per dozen, \$5.50.

**ATKINS STAIR BUILDERS' SAW.**



Beech Handle, Varnished Edge. Length 6, 8 and 10-inch.  
Price, per dozen, \$6.50.

**CARPENTERS' HANDY SAW.**



Silver-Steel, Apple Handle, Carved.

Inches ..... 17  
Per dozen ..... \$15 00

Put up one-third dozen in a box.

**DEHORNING SAWS.**

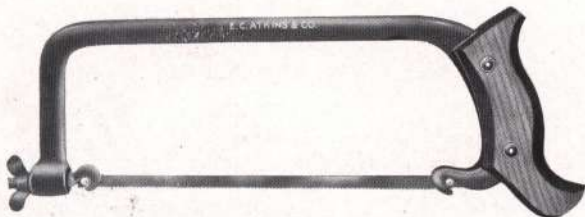

Japanned, Malleable Iron Frame, Beech Handle, Complete.  
Blades, 9½ inches long, ¼ inch wide.

Price, complete ..... Per dozen, \$8 00  
Price, Blades only ..... Per dozen, 1 50

Put up one-half dozen in a box.



**ATKINS COMPASS SAWS.**

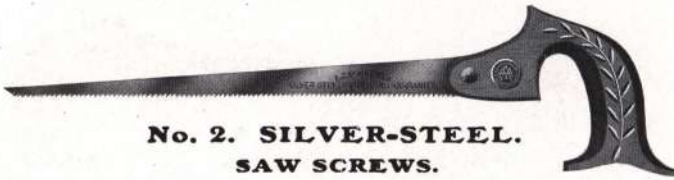

**No. 2. SILVER-STEEL. SAW SCREWS.**

Carved and Polished Apple Handle.

Inches .....	10	12	14	16	18
Per dozen.....	\$5 00	5 25	5 50	5 75	6 00
Blades only,.....	3 00	3 25	3 50	3 75	4 00



**No. 3. SILVER-STEEL. SAW SCREWS.**

Carved and Polished Beech Handle.

Inches .....	10	12	14	16
Per dozen .....	\$5 00	5 00	5 00	5 00

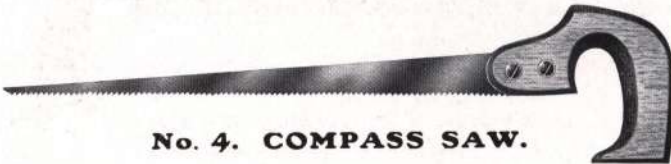

**No. 4. COMPASS SAW.**

Beech Handle, Varnished Edge.

Inches .....	10	12	14	16
Per dozen .....	\$3 00	3 00	3 00	3 00

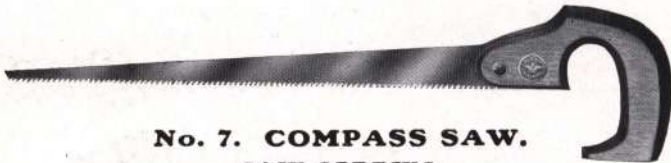

**No. 7. COMPASS SAW. SAW SCREWS.**

Beech Handle, Varnished Edge.

Inches .....	10	12	14	16
Per dozen .....	\$3 50	3 50	3 50	3 50

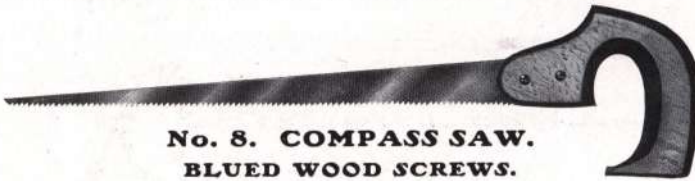

**No. 8. COMPASS SAW. BLUED WOOD SCREWS.**

Beech Handle, Varnished Edge.

Inches .....	10	12	14	16
Per dozen .....	\$2 50	2 50	2 50	2 50

All above put up half-dozen in a box.

## ATKINS COMPASS AND KEYHOLE SAWS.



**No. 9. COMPASS SAW.**

Saw Screws. Beech Handle.

Inches .....	10	12	14	16
Per dozen .....	\$3 25	3 25	3 25	3 25

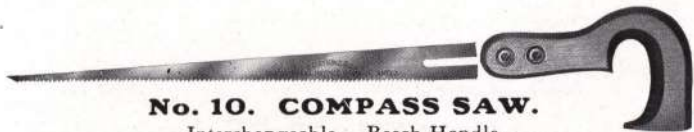

**No. 10. COMPASS SAW.**

Interchangeable. Beech Handle.

Inches .....	10	12	14	16	18	20
Per dozen .....	\$4 50	4 75	5 00	5 25	5 75	6 25

### INTERCHANGEABLE COMPASS SAW BLADES.

Inches .....	10	12	14	16	18	20
Per dozen .....	\$2 50	2 75	3 00	3 25	3 50	3 75

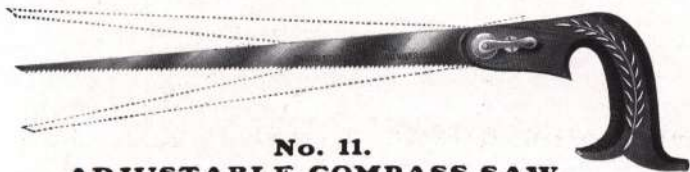

**No. 11.  
ADJUSTABLE COMPASS SAW.**

Apple Handle, Carved and Polished.

Inches .....	10	12	14	16	18
Per dozen .....	\$6 50	6 75	7 00	7 25	7 50
Blades only, per dozen .....	3 00	3 25	3 50	3 75	4 00

### KEYHOLE SAW AND PAD.

Keyhole Saws, per doz.	\$1 60
Handle.....	70
Complete ....	2 30

Put up one dozen in a box.

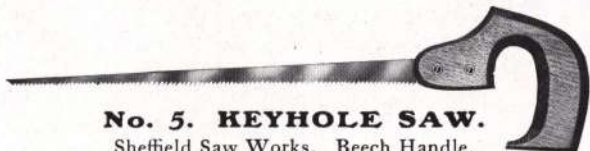

**No. 5. KEYHOLE SAW.**

Sheffield Saw Works. Beech Handle.

10 inches .....	Per dozen, \$2 50	12 inches .....	Per dozen, \$2 50
-----------------	-------------------	-----------------	-------------------

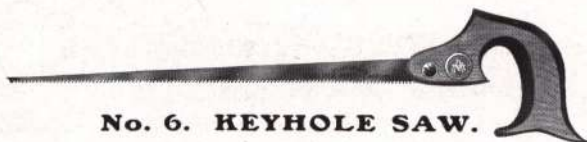

**No. 6. KEYHOLE SAW.**

Saw Screws. E. C. Atkins & Co. Apple Handle.

10 inches .....	Per dozen, \$4 50	12 inches .....	Per dozen, \$4 50
-----------------	-------------------	-----------------	-------------------

Compass and Keyhole Saws put up one-half dozen in a box.

# ATKINS SILVER STEEL SAWS

## ATKINS NESTS OF SAWS.



**No. 1.** Combining one each Keyhole, Compass and Pruning Saw.

Handle and Screws .....	Per doz. \$2 00	Pruning Saw, 18 in. long.....	Per doz. \$5 50
Keyhole Blades, 12 in. long..	“ 2 00		
Compass Blades, 14 in. long..	“ 3 00	Total for Nests.....	“ \$12 50

**No. 2.** Combining one each Keyhole, 12 and 16-inch Compass Blades.

Handle and Screws .....	Per doz. \$2 00	16-inch Compass Blades .....	Per doz. \$3 25
10-inch Keyhole Blades .....	“ 2 00		
12-inch Compass Blades.....	“ 2 75	Total for Nests.....	“ \$10 00

Put up three sets in a box.

The above Nests can be furnished with our patent adjustable handle as follows:  
 No. 1 Nest List .....



### No. 3. WITH METAL CUTTING BLADE.

The Nest complete, consists of a Metal Cutting Blade of hardened Silver-Steel, a Compass Saw, a Keyhole Saw and a highly finished adjustable handle.

The Metal Cutting Blade is taper ground from tooth edge to back and will cut a sufficiently wide kerf so that after the metal is cut, the Saw may be withdrawn and an ordinary Hand Saw properly set will clear the metal without injury.

Handle and Screws.....	Per doz. \$3 50	18-in. Special Nail Cutting Blade..	Per doz. \$11 50
12-inch Keyhole Blade..	“ 2 00		
14-inch Compass Blade..	“ 3 00	Total for Nests.....	“ \$20 00

## ATKINS PRUNING SAWS.



### No. 1. TABLE AND PRUNING SAW.

Silver-Steel, Beech Handle, Polished Edge.

Inches .....	12	14	16	18	20	22	24	26
Per dozen.....	\$6 00	6 50	7 00	7 75	8 50	9 25	10 00	11 00

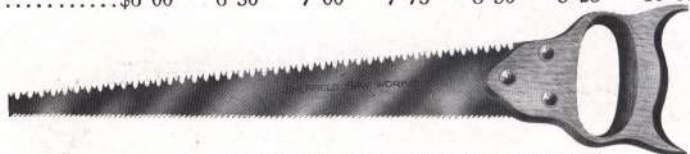

### No. 2. DUPLEX PRUNING SAWS.

Sheffield Saw Works. Special Steel, Beech Handle.

Inches .....	12	14	16	18	20	22
Per dozen.....	\$6 00	6 50	7 00	8 00	9 00	10 00



**ATKINS PRUNING SAWS.**

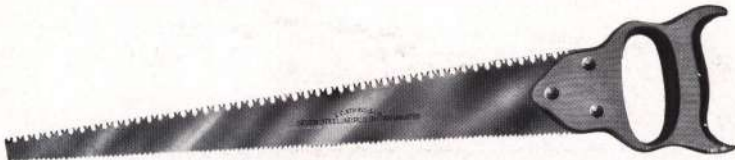

**No. 3. DUPLEX PRUNING SAW.**

Silver-Steel, Apple Handle.

Inches .....	12	14	16	18	20	22
Per dozen.....	\$8 50	9 00	9 50	10 50	11 50	12 50



**No. 4.**

High-Grade Steel, Carved and Polished Beech Handle.

20-inch only..... Per dozen, \$12 00



**No. 12. PARAGON PRUNING SAW.**

Silver-Steel, Beech Handle.

Inches .....	12	14	16	18	20	22
Per dozen.....	\$8 50	9 00	9 50	10 50	11 50	12 50

All above put up one-third dozen in a box.

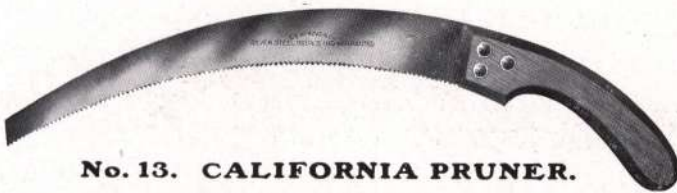

**No. 13. CALIFORNIA PRUNER.**

Silver-Steel, Apple Handle.

Inches .....	12	14
Per dozen.....	\$7 70	9 10

Put up one-half dozen in a box.



**No. 20. CALIFORNIA PRUNER.**

Special Steel, Hardwood Handle.

Inches .....	12	14
Per dozen.....	\$7 70	9 10

ATKINS TAPERED PRUNING SAWS.

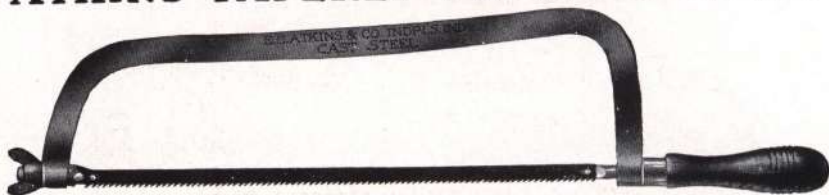

No. 6.

Polished Steel Spring Frame, Hardwood Handle.  
Blade is adjustable and can be set to cut at any angle. Length of blade 14 inches, center to center of holes.

List price ..... Per dozen, \$18 00  
List price extra blades..... " 4 00

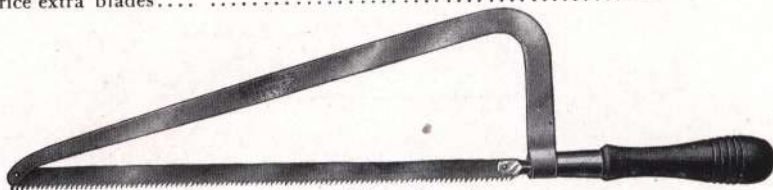

No. 8.

Polished Spring Steel Frame, Hardwood Handle, Double Swivel.  
Length of blade 14 inches, center to center of holes.

List Price..... Per dozen, \$16 00  
List Price extra blades..... " 4 00

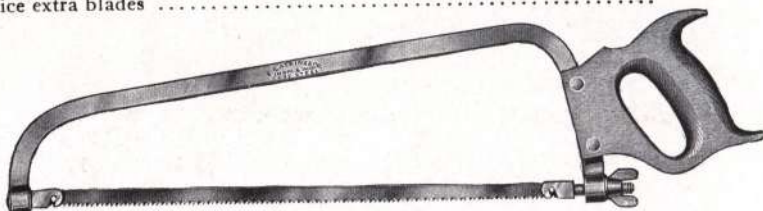

No. 10.

Steel Frame  $\frac{5}{8}$  x  $\frac{1}{4}$ -inch; Improved Double Swivel adjustment for Blade; Beech Handle;  
Depth at Heel, 5-inch; Depth at Point,  $2\frac{3}{4}$ -inch; Blades  $\frac{3}{8}$ -inch Wide.

Inches.....	14	16	18	20
List Price.....	Per dozen, \$18 75	19 75	20 75	21 75
List Price extra blades.....	2 25	2 75	3 25	3 75

Packed  $\frac{1}{3}$  dozen in box.

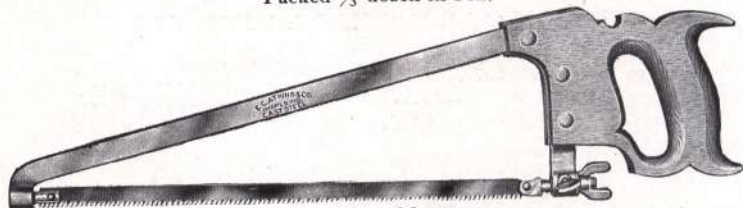

No. 11.

Flat Steel Back  $\frac{3}{4}$  x  $\frac{3}{8}$ -inch; Depth at Heel,  $4\frac{1}{4}$ -inch; Depth at Point,  $\frac{3}{4}$ -inch; Improved Double Swivel for Adjusting Blade; Special Beech Handle; Three Nickel-Plated Screws; Thumb Screw Tightener fastens tension device to insure positive position and tension in blade.

Inches.....	14	16	18	20
List Price.....	Per dozen, \$19 25	20 25	21 25	22 25

Packed  $\frac{1}{3}$  dozen in box.

**ATKINS BUTCHER SAWS.**

**No. 1. OVAL STEEL BACK.**

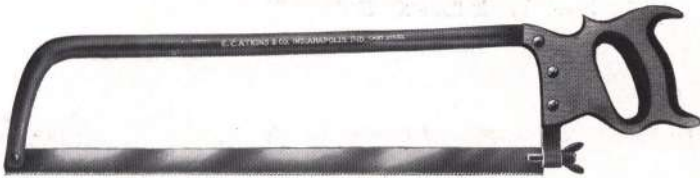

Oval Back,  $\frac{3}{4}$  x  $\frac{3}{8}$  inch. Silver-Steel Blade, Bright, Beech Handle.  
Three Nickeled Screws.

Inches .....	12	14	16	18	20	22	24
Per dozen.....	\$16 70	17 55	18 40	19 55	20 70	21 85	23 00

**No. 2. FLAT STEEL BACK.**



Flat Back, Square Edge,  $\frac{3}{4}$  x  $\frac{1}{4}$  inch. Special Steel Blade, Bright,  $\frac{3}{4}$ -inch wide.  
Beech Handle. Three Blued Wood Screws.

Inches .....	12	14	16	18	20	22	24
Per dozen.....	\$13 00	13 60	14 45	15 30	16 15	17 00	17 85

**No. 3. FLAT STEEL BACK.**

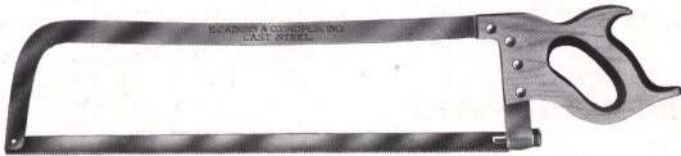

Flat Back, Square Edge, 1 x  $\frac{1}{4}$  inch. Silver-Steel Blade, Bright,  $\frac{3}{4}$ -inch wide.  
Beech Handle. Four Nickeled Screws.

Inches .....	14	16	18	20	22	24	26	28
Per Dozen.....	\$16 00	17 00	18 15	19 30	20 45	21 60	22 75	23 90

**No. 5. FLAT STEEL BACK.**



Flat Back, Square Edge, 1 x  $\frac{1}{4}$  inch. Silver-Steel, Blued Clock-Spring Blade,  $\frac{3}{4}$ -inch wide. Beech Handle. Four Nickeled Screws.

Inches .....	18	20	22	24	26
Per dozen.....	\$25 00	26 00	27 00	28 00	29 00

Above put up one-third dozen in a box.



**ATKINS BUTCHER SAWS.**

Continued.

**No. 7. FLAT STEEL BACK.**



Flat Back, Square Edge, 1 x 1/4-inch. Silver-Steel Blade, Bright, 5/8-inch wide.  
Beech Handle. Four Nickeled Screws.

Inches .....	14	16	18	20	22	24	26	28
Per dozen.....	\$16 00	17 00	18 15	19 30	20 45	21 60	22 75	23 90

**No. 77. FLAT STEEL BACK.**

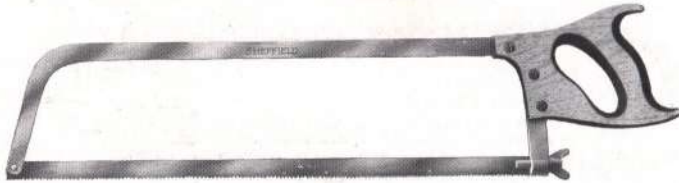

Flat Back, Square Edge, 3/4 x 1/4-inch. Special Steel Blade, Bright or Blued, 3/4-inch wide.  
Beech Handle. Three Nickeled Wood Screws.

Inches .....	14	16	18	20	22	24	26	28	30
Per dozen.....	\$16 00	17 00	18 15	19 30	20 45	21 60	22 75	23 90	25 05

**No. 78. FLAT STEEL BACK.**



Flat Back, Square Edge, 3/4 x 1/4-inch. Special Steel, Blued, Clock-Spring Blade,  
3/4-inch wide. Beech Handle. Three Nickeled Saw Screws.

Inches .....	14	16	18	20	22	24	26	28	30
Per dozen.....	\$17 00	18 00	19 15	20 30	21 45	22 60	23 75	24 90	26 05

**No. 79. FLAT STEEL BACK.**



Flat Back, Square Edge, 1 x 1/4-inch. Special Steel Blade, Bright, 3/4-inch wide.  
Beech Handle. Three Nickeled Saw Screws.

Inches .....	14	16	18	20	22	24	26	28	30
Per dozen.....	\$16 00	17 00	18 15	19 30	20 45	21 60	22 75	23 90	25 05

Above put up one-third dozen in a box.

## ATKINS BUTCHER SAWS.

Continued.

### No. 10. FLAT STEEL BACK.

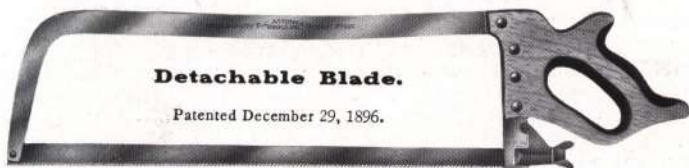

Flat Back, Square Edge, 1 x 1/4 inch. Silver-Steel Blade, Bright, 3/4-inch wide.  
Beech Handle. Four Nickeled Screws.

Inches .....	14	16	18	20	22	24	26	28	30
Per dozen .....	\$16 00	17 00	18 15	19 30	20 45	21 60	22 75	23 90	25 05

### No. 11. FLAT STEEL BACK.

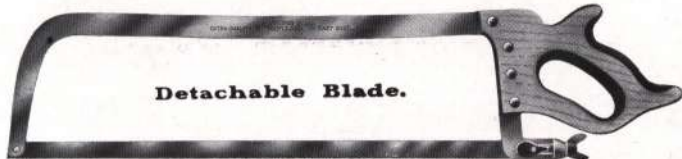

Flat Back, Square Edge, 1 x 1/4 inch. Silver-Steel Blade, Bright, 3/4-inch wide.  
Beech Handle. Four Nickeled Screws.

Inches .....	14	16	18	20	22	24	26	28	30
Per dozen .....	\$16 00	17 00	18 15	19 30	20 45	21 60	22 75	23 90	25 05

### No. 12. FLAT STEEL BACK.

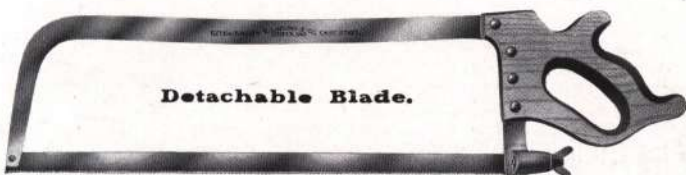

Flat Back, Square Edge, 1 x 1/4 inch. Silver-Steel Blade, Bright, 3/4-inch wide.  
Beech Handle. Four Nickeled Screws.

Inches .....	14	16	18	20	22	24	26	28	30
Per dozen .....	\$16 00	17 00	18 15	19 30	20 45	21 60	22 75	23 90	25 05

Put up one-third dozen in a box.

## BUTCHER BLADES.

### CLOCK SPRING-STEEL, BLUED OR BRIGHT.

3/4 inch to 1 1/4 inches wide, inclusive.

Inches .....	12	14	16	18	20	22	24	26	28
Per dozen .....	\$4 15	4 40	4 65	4 90	5 15	5 40	5 65	5 90	6 15

1 1/2 inches to 2 inches wide, inclusive.

Inches .....	16	18	20	22	24	26	28	30	32	34	36
Per dozen .....	\$6 00	6 25	6 50	6 75	7 00	7 25	7 50	7 75	8 00	8 25	8 50

**ATKINS BUTCHER SAWS  
IN COILS.**

**MACHINE SET AND SHARPENED.**

Inches.....	½	⅝	¾	⅞	1	1⅛	1¼
Per foot, list..	\$0 12	0 14	0 16	0 18	0 20	0 22	0 24

Put up in coils in handsome cardboard boxes. Coils 25 feet in length will be sent unless otherwise ordered.



**BEEF SPLITTING SAWS.**

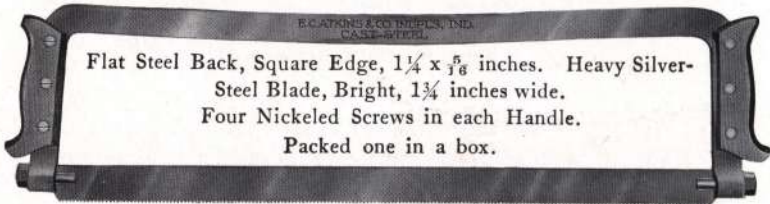

Inches .....	24	26	28	30	32	34	36
Each, complete.....	\$4 50	4 75	5 00	5 50	6 00	6 50	7 00
Blades only, per dozen.....	8 00	8 25	8 50	8 75	9 00	9 25	9 50



Flat Back, 1¼ x ⅝ inches, Square Edge. Round Eye, Round Tension Spring, Hexagon Nut, Silver-Steel Blade, 1¼-inch wide. Beech Handle. Four Nickel-plated Screws.

Inches .....	24	26	28	30	32	34	36
Per dozen.....	\$26 00	27 65	28 75	30 25	31 75	33 25	34 75

**PORK PACKERS' SAWS.**

**No. 1.**

**OVAL STEEL BACK.**

Put up one-half dozen in a box.

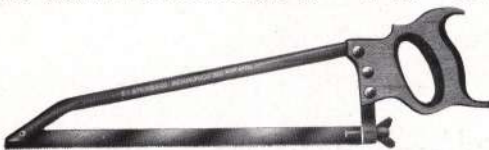

Oval Back, ⅝ x ⅜-<sup>1</sup>/<sub>8</sub>-inch. Silver-Steel, Blued Clock Spring Blade, ¾-inch wide. Beech Handle. Three Nickel-plated Screws.

Inches .....	14	16	18
Per dozen.....	\$17 50	18 50	19 50



## ATKINS KITCHEN SAWS.

### No. 8. FLAT STEEL BACK.



Flat Back,  $\frac{5}{8} \times \frac{3}{16}$  inches. Special Steel Blade, Bright,  $\frac{5}{8}$  inch wide. Beech handle, Three Blued Wood Screws.

Inches .....	12	14	16
Per dozen.....	\$5 00	5 00	5 00

### No. 9. OVAL STEEL BACK.

Sheffield Saw Works.

Oval Back,  $\frac{1}{2} \times \frac{1}{4}$  inches. Special Steel Blade, Bright,  $\frac{5}{8}$  inch wide. Beech Handle, Two Blued Wood Screws.

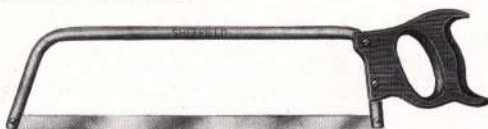

Inches .....	12	14	16
Per dozen.....	\$4 50	4 50	4 50

### No. 13. FLAT STEEL BACK.

Extra High Grade.

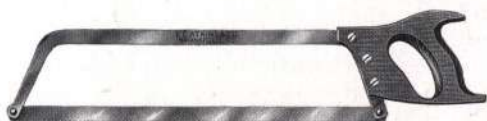

Flat Back,  $\frac{5}{8} \times \frac{3}{16}$  inches. Silver-Steel Blade, Bright,  $\frac{3}{4}$  inch wide. Beech Handle, Three Nickered Wood Screws.

Inches .....	12	14	16	18
Per dozen.....	\$8 50	8 50	8 50	8 50

### No. 14. FLAT STEEL BACK.

Extra High Grade.

Flat Back,  $\frac{3}{4} \times \frac{1}{4}$  inches. Silver-Steel Blade, Bright,  $\frac{3}{4}$  inch wide. Beech Handle, Three Nickered Wood Screws.



Inches .....	12	14	16	18
Per dozen.....	\$12 00	12 00	12 00	12 00

Put up one-half dozen in a box.

### LIST KITCHEN SAW BLADES.

$\frac{5}{8}$  inch wide. Set and sharp (but not filed). Ready for use.

Inches .....	12	14	16	18	20	22	24	26	28
Per dozen.....	\$0 80	0 90	1 00	1 15	1 30	1 50	1 75	2 00	2 25

### SAW KNIFE.



Price, per dozen, \$6.00.

Saw Knives put up one dozen in a box.

## ATKINS BUTCHER SAW PUNCH.



The punching of necessary holes in Butcher Saw Blades has been the source of much annoyance to users of and dealers in this article. None of the better class of Butcher Saw Blades are punched when they leave the factory. There is so much variation in the styles of frames of apparently the same length that it would be impossible to do it and have them come out right. This little device suggested itself and came into existence because of the above condition. It is appreciated at sight.

The frame is of malleable iron, nickel-plated and polished. The screw and cross bar are of steel, handsomely finished. The die and punch are of the finest quality of tool steel, carefully tempered.

List Price, per dozen, \$9.00.

## ATKINS HAND SAW HANDLES.

**Price Does Not Include Screws.**



		16-18-20 in.	22-24 in.	26 in.	28 in.
No. 51, 55, 66, 67, 70, Apple.....	Per dozen,	\$3 65	\$4 00	\$4 85	\$5 20
No. 64, Apple.....	"	6 40	6 70	7 90	8 25
No. 52, Apple.....	"	4 85	5 20	6 10	6 40
No. 53, 61, 65, 68, 69, 73, 93, 96, Apple....	"	4 85	5 20	6 10	6 40
No. 54, 74, Beech.....	"	2 75	2 75	3 05	3 35
No. 76, 86, Apple.....	"	3 65	4 00	4 85	5 20
No. 56, Cherry.....	"	3 50	3 75	4 00	4 50
No. 57, 60, Beech.....	"	1 50	1 60	1 70	2 00
No. 58, Beech, varnished edges.....	"	....	....	1 50	....
No. 58, Beech, unvarnished.....	"	....	....	1 35	....
No. 59, 99, Beech.....	"	1 50	1 60	1 70	2 00
No. 63, Beech.....	"	2 10	2 10	2 45	2 65
No. 62, Beech.....	"	1 50	1 60	1 70	2 00
No. 400, 401, Rosewood.....	"	15 50	16 50	18 00	19 50

### MITRE BOX HANDLES.

No. 1, Apple.....	Per dozen	18-24 in.	26-32 in.
		\$5 00	5 50

### BACK SAW HANDLES.

No. 2, Apple.....	Per dozen	8-12 in.	14-18 in.	20-24 in.
		\$3 25	3 50	....
No. 3, Beech.....	"	1 25	1 25	1 25

### COMPASS SAW HANDLES.

No. 2, Apple.....	Per dozen,	\$3 25	Interchangeable, Beech....	Per dozen,	\$1 75
No. 3, Beech.....	"	1 50	No. 8, Beech, var. edge ...	Per dozen,	1 25

### BUTCHER SAW HANDLES.

No. 1, Beech.....	Per dozen,	\$2 00	No. 7, Beech.....	Per dozen,	\$2 25
No. 2, Beech.....	"	1 75	No. 8, Kitchen, Beech....	"	1 75
No. 5, Beech.....	"	2 25			

### PRUNING SAW HANDLES.

No. 1, Beech.....	Per dozen,	\$1 75	No. 2, Beech.....	Per dozen,	\$1 75
-------------------	------------	--------	-------------------	------------	--------

Screws for all Handles extra. Saw Handles put up one dozen in a box.



ATKINS SAW SCREWS.

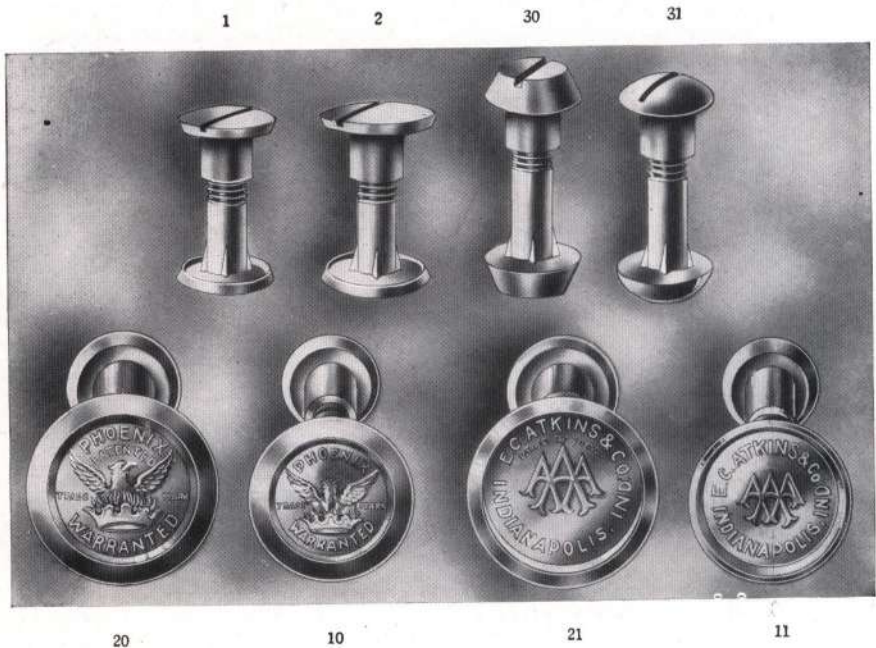

No. 1	Oval Head, Plain Brass Screw, small	Per gross, \$3 00
No. 2	Oval Head, Plain Brass Screw, large	" 3 50
No. 10	Eagle Medallion, small	" 4 50
No. 11	AAA Medallion, small	" 5 00
No. 20	Eagle Medallion, large	" 5 50
No. 21	AAA Medallion, large	" 6 00
No. 31	Button Head, Brass Screw	" 3 50
No. 30	Raised Head, Iron Screw	" 3 00



These Screws are put up one dozen assorted in small pasteboard boxes and one dozen of these packages are packed in a large carton.

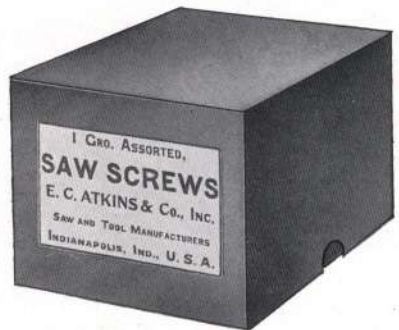

We also put up two assortments of Screws in a most convenient and saleable form, as follows:—

ASSORTMENT No. 1 consists of a carton containing 36 small boxes, each box containing three only No. 1 and one only No. 10 Brass Saw Screws, and is adapted for the use of carpenters who want screws for Panel Saws and the cheaper grade of Hand Saws.

ASSORTMENT No. 2 consists of a carton containing 36 small boxes, each containing three only No. 2 and one only No. 20 Brass Saw Screws and is adapted for High-Grade Hand and Rip Saws.

ASSORTMENT No. 3. 3 No. 1, 3 No. 2, and one each 30, 31, 20, 10, 21, 11.

List Prices.

No. 1 assortment, each carton containing one gross assorted as above, (36 boxes)	\$4 00
No. 2 assortment, each carton containing one gross assorted as above, (36 boxes)	4 50
No. 3 assortment, each carton containing 12 boxes, (1 dozen in box)	4 00

## ATKINS LINE OF COPING SAWS.

### "JONES" CABLE COPING SAW No. 1.

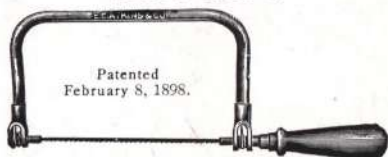

Patented  
February 8, 1898.

Frame is heavily nickel plated, polished, buffed and fitted with hardwood handle; furnished complete with one-half dozen blades, packed in cardboard boxes. Frame carries 6-in. blade and is 4 in. deep from blade to back.

List price, per dozen, \$15.00.

Frames Nos. 1 and 7 are constructed with tubular back, through which runs a cable connecting both ends of frame, which causes the blade to turn to any angle by turning the handle only, without removing it from the work.

### "JONES" RATCHET COPING SAW No. 2.

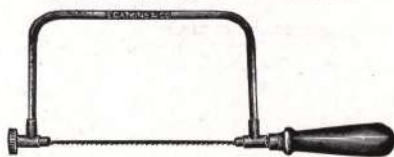

Patented November 5, 1901.

Frame is heavily nickel plated, polished, buffed and fitted with hardwood handle; furnished complete with one-half dozen blades, packed in cardboard boxes. Frame carries a 6-inch blade and is 4 inches deep from blade to back.

List price, per dozen, \$9.00.

Frames Nos. 2 and 3 are constructed with a steel back and ratchet arrangement (see illustration) which enables the workman to set the blade at any angle by the handle and button at the other end of saw frame.

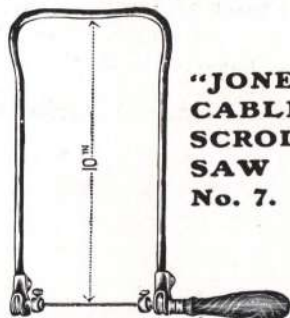

### "JONES" CABLE SCROLL SAW No. 7.

Patented February 8, 1898.

Special attention is called to construction of the grips or clamps for holding the saw blades; they are strongly made of steel and hardened; when properly tightened blade cannot slip. Frames are made to take 5-in. saw blade and are 10 in. deep from blade to back.

Frame is heavily nickel plated, polished, buffed and fitted with hardwood handle; furnished complete with blade and packed in cardboard boxes.

List price, per dozen, \$18.00.

Above put up one-sixth dozen in a box.

### "JONES" RATCHET SCROLL SAW No. 3.

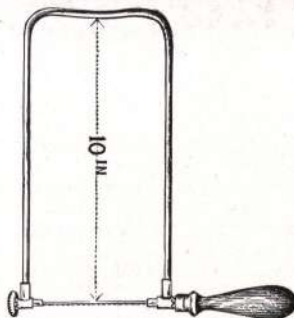

Patented November 5, 1901.

Frame is heavily nickel plated, polished, buffed and fitted with hardwood handle; furnished complete with one-half dozen blades, packed in cardboard boxes. Frame carries a 6-inch blade and is 10 inches deep from blade to back.

List price, per dozen, \$10.00.

### "JONES" CABLE JEWELER SAW No. 6.

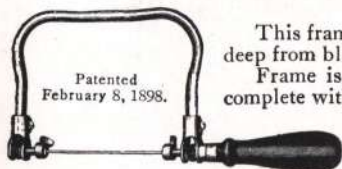

Patented  
February 8, 1898.

This frame is made to take a 5-inch saw blade, and is 3½ inches deep from blade to back.

Frame is nickel plated and fitted with hardwood handle; furnished complete with blade and packed in cardboard boxes.

List price, per dozen, \$15.00



## ATKINS COPING SAWS—Cont'd.

### COPING SAW No. 100.

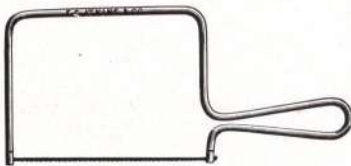

All wire, heavily nickel plated, polished and buffed. Adjustable frame. 6-inch bent end blades. Depth from blade to back 4 inches.

Complete with one dozen extra blades,  
per dozen .....\$3 25  
Extra blades, per gross..... 1 66

**No. 101.** Same as No. 100,  
except 8-inch under back.....\$3 75

### COPING SAW No. 110.

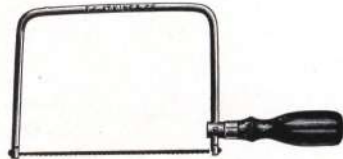

Wire frame, heavily nickel plated, polished and buffed; adjustable; with black wood handle. 6-inch bent end blades. Depth from blade to back 4 inches.

Complete with one dozen extra blades,  
per dozen.....\$4 00  
Extra blades, per gross..... 1 66

**No. 111.** Same as No. 110,  
except 8-inch under back.....\$4 50

## COPING SAW BLADES.

The following list contains description and list prices of REGULAR and SPECIAL BLADES used in the "Jones" Patent Coping and Scroll Saw Frames.

### COPING SAW BLADES.

6-inch—For Nos. 1, 2 and 3 frames,  
per gross.....\$1 66  
Put up regularly with the Nos. 1, 2 and 3 frames.

### SPECIAL COPING OR WEB SAW BLADES.

½-inch wide, 12 points per inch.

6-inch—For Nos. 1, 2 and 3 frames,  
per dozen .....\$0 90

This blade is for rapid work, where speed rather than fine, smooth work is desired.

### SCROLL OR FRET SAW BLADES.

5-inch—For Nos. 6 and 7 frames, per  
gross .....\$1 40  
Put up regularly with the No. 7 frame.

### List of Finer Sizes.

No. 6 .....per gross, \$1 00  
No. 7 .....per gross, 1 10  
No. 8 .....per gross, 1 20  
No. 9 .....per gross, 1 30

## JEWELERS' SAW BLADES FOR METAL WORK.

5-inch—Square Blade, for Nos. 6 and  
7 frames, per gross .....\$1 40

This blade is put up regularly with the No. 6 frame.  
Finer sizes furnished if desired at same price.

### SPECIAL JEWELERS' SAW BLADES.

For Metal Work.

5-inch—For Nos. 6 and 7 frames, per  
gross .....\$1 90

This is a very thin, flat blade for fine work on metals. Nos. 4 and 6 (narrower) and Nos. 10 and 11 (wider) at same price.

### SPECIAL HACK SAW BLADES.

For Metal Work.

¼-inch wide, 014-inch thick, 30 teeth per inch.

6-inch—For Nos. 1, 2 and 3 frames,  
per dozen .....\$0 75

5-inch—For Nos. 6 and 7 frames,  
per dozen ..... 70

By using these blades a large variety of metal work can be done with our Coping Saw Frames.



**ATKINS COPING SAWS.**

**Continued.**

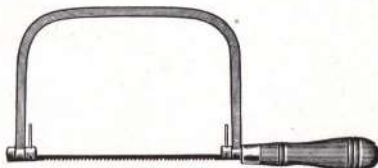

**Coping Saw No. 50.**

This is a strictly High Grade Tool, sold at a moderate price.

The construction is strong, durable and its action perfect.

The back is  $\frac{3}{8}$  inches wide and  $\frac{3}{16}$  inches thick and made of cold rolled steel, nickered and buffed. Frame,  $7\frac{1}{4}$  inches by  $4\frac{5}{8}$  inches deep.

It is fastened to the handle by a malleable iron threaded ferrule, thus producing what is perhaps the strongest attachment for this purpose now in use.

All parts handsomely nickered and buffed.

The handle is of hardwood, easy grip pattern, carved and varnished.

Through the use of cap screws into which wires are inserted, the blade may be instantly adjusted to cut sharp or unusual angles with perfect ease and without strain on the blade.

While this Saw costs a trifle more than the ordinary Coping Saw, it is so much more satisfactory and durable that the mechanic who appreciates fine tools will prefer it to any other.

**List Prices.**

Complete with blade, per dozen .....	\$10 00
Blades only, per dozen .....	85

**ATKINS  
FLOOR AND CABINET SCRAPERS.  
THE "PERFECTION" SCRAPER.**



**ADJUSTABLE.**

List price ..... Per dozen, \$10 00  
 Extra Blades, 3 x 3 in. Atkins  
 Silver-Steel, 16 gauge, beveled, Per dozen, \$1 40  
 Put up one-half dozen in a box.

**SPECIAL FLOOR SCRAPER BLADES.**

**High Temper. Beveled Edge.**  
 3 x 3 inches..... Per dozen, \$1 40      3 x 6 inches..... Per dozen, \$2 00



**CABINET  
SCRAPERS.**



**No. 1. SILVER-STEEL.**

Six inches in length, 20 gauge.

	Per Doz.		Per Doz.
2 in. wide.....	\$1 00	4 in. wide.....	\$1 80
2½ " " " " " "	1 20	4½ " " " " " "	2 00
3 " " " " " "	1 40	5 " " " " " "	2 20
3½ " " " " " "	1 60		

**COMMON QUALITY No. 2.**

Six inches in length, 19 gauge.

	Per Doz.		Per Doz.
2 in. wide.....	\$0 50	4 in. wide.....	\$0 90
2½ " " " " " "	60	4½ " " " " " "	1 00
3 " " " " " "	70	5 " " " " " "	1 10
3½ " " " " " "	80		

NOTE—Unless otherwise specified Common Quality Scrapers are sent on all orders.

Put up one dozen in a box.

**Cabinet Scrapers assorted one dozen in a box.**

**No. 1.**

Length	Width	Price
1-2½ inches	5 inches long	
2-3 "	" "	5 "
2-3½ "	" "	5 "
1-2½ "	" "	6 "
2-3 "	" "	6 "
2-3½ "	" "	6 "
2-4 "	" "	6 "

List price, per dozen for assortment, ..\$1 50

**No. 2.**

Length	Width	Price
1-2½ inches	5 inches long	
2-3 "	" "	5 "
2-3½ "	" "	5 "
1-2½ "	" "	6 "
2-3 "	" "	6 "
2-3½ "	" "	6 "
2-4 "	" "	6 "

List price, per dozen for assortment, ..\$0 75

**THE "RAMS-HORN" FLOOR AND  
CABINET SCRAPERS.**



List price..... Per dozen, \$10 00

Put up one each in a box.

Extra Blades, Atkins Silver-Steel, 19 gauge..... Per dozen, \$1 60  
 Extra Blades, Common Quality, 19 gauge ..... Per dozen, 80

**ATKINS BENCH SCRAPERS.**

**No. 1. Curved Shank.**

List price ..... Per dozen, \$5 00  
 Extra blades ..... " 2 00

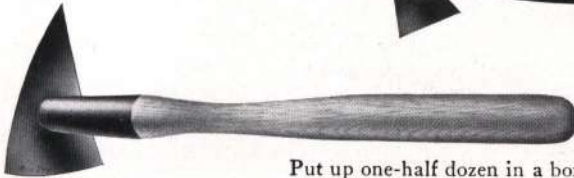
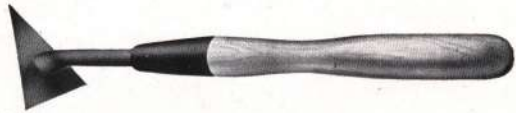

**No. 2. Long Steel Thimble.**

List Price... Per dozen, \$5 00  
 Extra blades, " 2 50

Put up one-half dozen in a box.

**BELT SCRAPERS OR HAND SLICKERS.**



**Belt Scraper or Hand Slickers.**

This Tool made with high grade steel blade and hardwood handles, nicely finished.

Each, 25 cents.

**WALL SCRAPERS.**

List price, per dozen.

3½ inch .....\$2 75  
 4 " ..... 3 00

**BLADES ONLY.**

List price, per dozen.

3½ inch .....\$1 10  
 4 " ..... 1 35

Put up one-half dozen in a box.



**Wall Scraper.**

**ATKINS HANDY TOOL.**

Set of Tools consists of Keyhole Saw and Pad, Putty Knife, Chisel, Screw Driver and Tack Claw. Put up one set in a box. Just the tools for home use.

**Price, Per Dozen.**



Handles .....\$0 70  
 Keyhole Saws ..... 1 60  
 Putty Knives ..... 1 50  
 Chisels ..... 1 00  
 Screw Drivers and Tack Claws 1 00  
 Tools, complete set..... 5 80

Price for one set Handy Tools, 50 cents. If sent by mail, 8 cents additional.



**ATKINS PLASTERING TROWELS.**

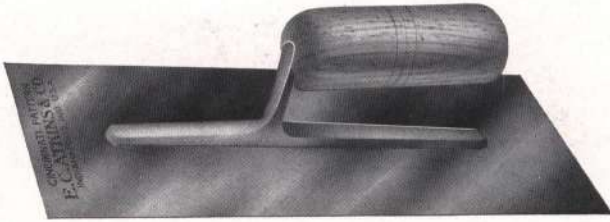

**No. 1. SILVER-STEEL FINISHING TROWEL.**

Inches .....	10	10½	11	11½	12	12½	13
Per dozen.....	\$13 50	14 50	15 50	16 75	18 00	19 50	21 56



**No. 2. CAST STEEL FINISHING TROWEL.**

Inches .....	10	10½	11	11½	12	12½	13
Per dozen.....	\$12 00	13 00	14 00	15 25	16 50	18 00	19 50



**No. 3. SILVER-STEEL FINISHING TROWEL.**

Inches .....	10	10½	11	11½	12	12½	13
Per dozen.....	\$23 50	24 50	25 50	26 75	28 00	29 00	31 50

Put up one-half dozen in a box.

**ATKINS PLASTERING TROWELS.**

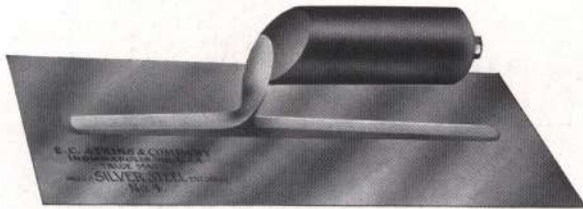

**No. 4. SILVER-STEEL FINISHING TROWEL.**

The finest, strongest and most desirable trowel on the market. Mounting is Cast Steel, with ten rivets. Handle is beveled off on the nose and fastened to shank with a hexagon nut; ebony finish and nicely polished.

Inches .....	10	10½	11	11½	12	12½	13
Per dozen.....	\$23 50	24 50	25 50	26 75	28 00	29 00	31 50

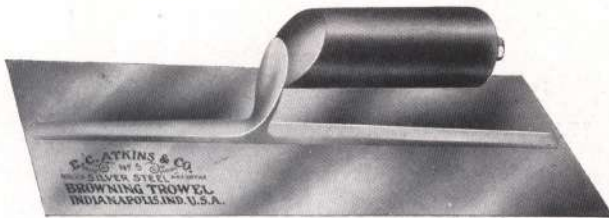

**No. 5. SILVER-STEEL BROWNING TROWEL.**

A strictly high grade tool. Material and workmanship all that could be desired. Same as No. 4, except heavier blade for browning.

Inches .....	11½x4¾	11½x5	12x4¾	12x5
Per dozen.....	\$26 75	26 75	28 00	28 00

21 Gauge.



**No. 6.**

**A SPECIAL TROWEL FOR EDGING CEMENT WALKS.  
SILVER-STEEL, WARRANTED.**

List price, 11½ inches long ..... Per dozen, \$20 00

Put up one-half dozen in a box.

**ATKINS PLASTERING TROWELS.**



**No. 10. FINISHING TROWEL.**  
**Indianapolis Pattern.**

Mounting covers within 1/2 to 5/8 inch of the end of the blade, thereby insuring stiffness throughout its entire length. Post, same as Cincinnati Pattern. Handles, black walnut of the same shape, size and pattern as used on the No. 1 Trowels. These handles can be nosed off to suit individual taste.

Blades 11 1/2-inch and longer have 12 rivets; 10-inch and under, 10 rivets.

**List Prices.**

Inches.....	10	10 1/2	11	11 1/2	12	12 1/2	13
Per dozen.....	\$23 50	24 50	25 50	26 75	28 00	29 00	31 50

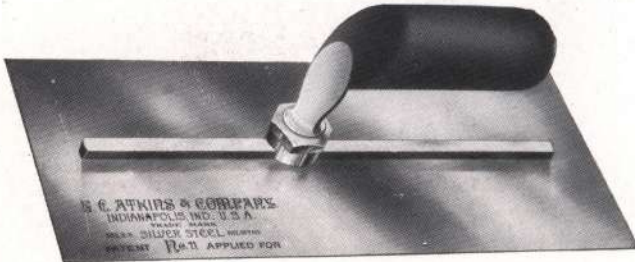

**No. 11. ADJUSTABLE TROWEL.**  
**Linville Pattern.**

The Blade is of Silver-Steel, the same as used in Atkins High Grade Saws.

The Bar A is fastened to the Blade by ten rivets and is beveled so as to hold a sliding Nut B, which is clamped to the bar by use of a hexagon Nut C, both of which are attached to the shank. By this device the handle may be moved along the bar so as to secure any desired balance, or may be entirely removed and folded in compact form for carrying in the bag.

The user is enabled to reverse the position of the blade and thus use either end, avoiding the wear on one end only, which the stationary handle involves.

By moving the handle it is possible for the user to reach into corners, back of radiators, or any unusual spot with ease, wherein through the use of the stationary handle it is impossible to do so.

The handle is of hardwood, ebony finish, easy grip pattern, rounded nose, non-turnable attachment and fastened with a hexagon nut.

Made from 22 to 26 gauge in thickness for plastering, finishing or browning.

Wrench for Hexagon nut supplied free with each trowel.

**Price List.**

10, 10 1/2, 11, 11 1/2, 12, 12 1/2, 13-inch .....	Per dozen,	\$33 50
Blades only, any of the above sizes.....	"	22 25
Extra Wrenches.....	"	1 20



**ATKINS SPECIAL SIDEWALK AND  
GUTTERING TROWELS.**



**No. 7. CURBING TROWEL.**

Silver-Steel Blade, 10 inches long, 5 inches wide, 5 inches deep,  $1\frac{1}{2}$  inches radius.

List price, per dozen, \$30.00.

Other Sizes to Order. Prices on Application.



**No. 8. RADIUS TROWEL.**

Silver-Steel Blade, 8 inches long,  $2\frac{1}{2}$  inches radius,  $\frac{1}{4}$  round.

List price, per dozen, \$30.00.

Other Sizes to Order. Prices on Application.



**No. 9. GUTTERING TROWEL.**

Silver-Steel Blade, 10 inches long, 5 inches wide, 5 inches deep,  $1\frac{1}{2}$  inches radius.

This trowel will be furnished with either style handle.

List price, per dozen, \$30.00.

Other Sizes to Order. Prices on Application.

**ATKINS CORN KNIVES.**

**Made from Fine Crucible Steel, High Tempered, Fully Warranted.**

Note the construction of these handles. Made for ease and comfort.



No. 1. Silver-Steel Corn Knife, polished bright, varnished handle.....Per dozen, \$3 50



No. 2. Special Steel Corn Knife, black blade, white unvarnished handle ...Per dozen, \$3 00



No. 3. Silver-Steel Corn Knife, polished bright, varnished handle.....Per dozen, \$3 50



No. 4. Silver-Steel Corn Knife, polished bright, varnished handle .....Per dozen, \$3 50



No. 6. Special Steel Corn Knife, hardwood handle.....Per dozen, \$3 00



No. 7. Special Steel Corn Knife, self-colored, varnished handle .....Per dozen, \$3 50

**HEDGE KNIVES.**



No. 8. Silver-Steel, polished bright .....Per dozen, \$5 00

All above (except No. 3) are packed one-half dozen in package.  
No. 3, one-half dozen in pasteboard box.

**ATKINS CANE KNIVES.**

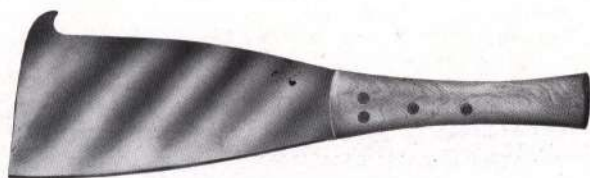

No. 10 Silver-Steel, 20 inches by 5 inches..... Per dozen, \$8 00  
Furnished with either straight or curved hook.



No. 11 Silver-Steel, 18 inches by 3¾ inches ..... Per dozen, \$7 00  
Furnished with either straight or curved hook.

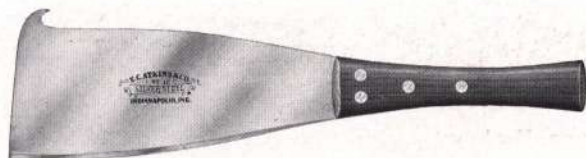

No. 12 Silver-Steel, 20 inches by 4¾ inches, Hardwood Handle, Easy Grip, Four Rivets.  
Per dozen, \$6.75.

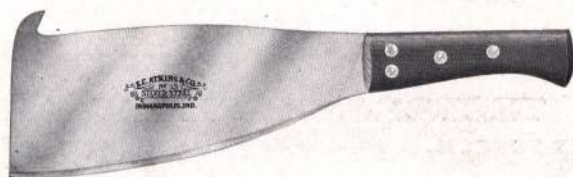

No. 13 Silver-Steel, 19½ inches by 5 inches, Hardwood Handle, Easy Grip, Four Rivets.  
Per dozen, \$8.50.



No. 14 Silver-Steel, 20 inches by 5 inches, Hardwood Handle, Easy Grip, Four Rivets.  
Per dozen, \$8.50.



**ATKINS BEET TOPPING KNIVES.**

**SILVER-STEEL. STRAIGHT KNIFE.**



- No. 1. Straight blade, 14 gauge ..... Per dozen, list, \$5 00
- No. 2. Straight blade, 11 gauge..... " " 5 60

**CURVED KNIFE.**



- No. 3. Curved blade, 14 gauge..... Per dozen, list, \$6 20
  - No. 4. Curved blade, 11 gauge... " " 6 80
- Packed one-half dozen in a box.

**STRAIGHT KNIFE.**



**No. 5.**

- No. 5. With Prong, Hardwood Handle, 2 Rivets, 15 Gauge..... Per dozen, \$7 25



**No. 6.**

- No. 6. Hardwood, Easy Grip Handle, 2 Rivets, 15 Gauge..... Per dozen, \$6 10

**FLOUR TESTERS.**

**FINE POLISH.**



- 3¼ x 8½, fine polish ..... Each, \$2 00
- 3 x 6¼ " ..... " 1 50
- 2 x 6 " ..... " 1 25

Nickel plated, 50 cents each net additional.

**SIDING AND TRY SQUARE.**

Patented  
December 22,  
1896.



Price, per dozen, \$8.50.

This is a very convenient tool for use in putting on siding of all kinds; also for all other purposes where a Try Square is used.

**THE MARSH-AYER MITER BOXES.**

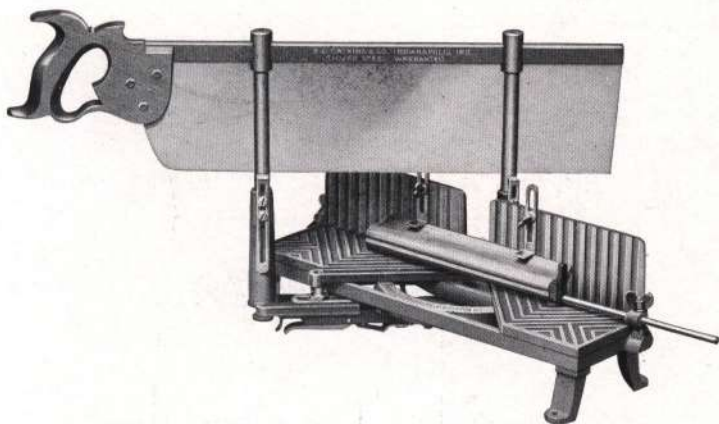

This device is too well known to require an introduction. We carry a full line, equipped with Atkins Back Saws. If you are not perfectly familiar with the construction of the Marsh-Ayer Box, write us for information and description.

Carried in the following sizes :

SIZE.	SAW.	EACH, INCLUDING SAW.
A-24	24 x 4	\$12 25
A-26	26 x 4	12 50
A-28	28 x 4	12 75
B-26	26 x 5	13 50
B-28	28 x 5	13 75
B-30	30 x 5	14 00

“A” Style for 4-inch and “B” for 5-inch Saws.

## ATKINS COMBINATION CORNER BRACE.

Patented Oct. 10, 1905.

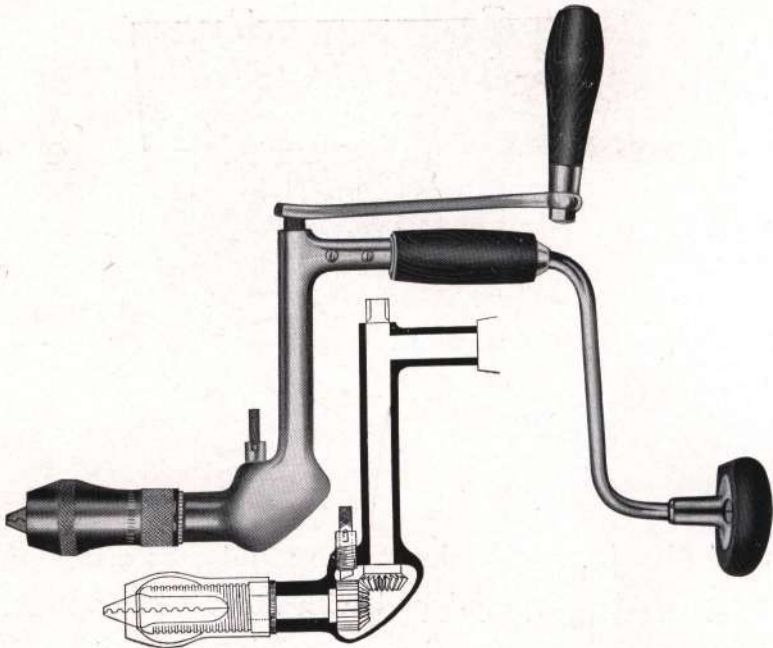

**A Tool Manufactured by us Exclusively Which Meets  
All Requirements.**

A combination of a Ratchet, Straight and Corner Brace, of the highest grade and the best finish. Highest polish and well nicked. Cocobolo head and handles. Ball bearing head. Holds any size of bits, and small size Round-shank Drill. As a Corner Brace it can be used where others will not go. It has no lost motion, has a positive drive, will work fast and drive the bit true at any angle, and with great power. It is particularly adapted for electricians, cabinet-makers and builders, and for rapid screw-driving.

Packed one-third dozen in metal edge boxes.

Made only in 10-inch size.

Weight, 36 pounds, complete.

**Price, \$48.00 Per Dozen.**



**ATKINS RATCHET BRACES.**

**Best Finish.  
Concealed Ratchet.  
Hardened  
Forged Steel  
Alligator Jaws.**

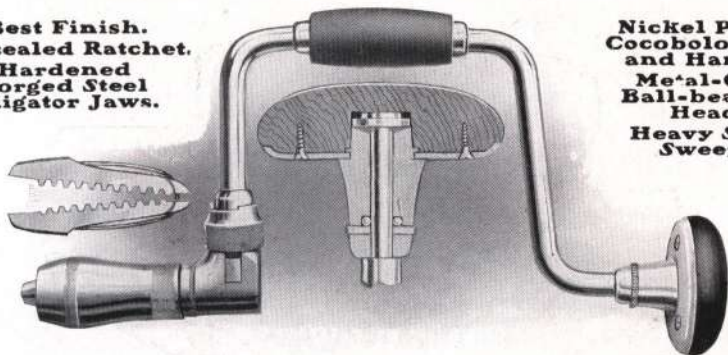

**Nickel Plated  
Cocobolo Head  
and Handle.  
Metal-Clad  
Ball-bearing  
Head.  
Heavy Steel  
Sweeps.**

**THE BEST BRACE MADE.**

Our Ratchet Braces above illustrated are first-class in every respect and fully guaranteed. The sweep, pawls, jaws and socket are of steel, well made, durable and rigid. Jaws are fitted with spring to keep them always ready for the bits, any size of which will easily fit this tool, as well as small sizes of round shank drills, holding them firmly.

No. 106.	6-inch	.....	per dozen,	\$36 00
No. 108.	8-inch	.....	"	39 00
No. 110.	10-inch	.....	"	42 00
No. 112.	12-inch	.....	"	45 00
No. 114.	14-inch	.....	"	48 00

Similar to above mentioned tools. Not ball-bearing head. Finely polished.

No. 208.	8-inch	.....	per dozen,	\$27 00
No. 210.	10-inch	.....	"	28 50
No. 212.	12-inch	.....	"	30 00

**Best Finish.  
Ring Ratchet.  
Hardened Forged  
Steel Alligator Jaws.**

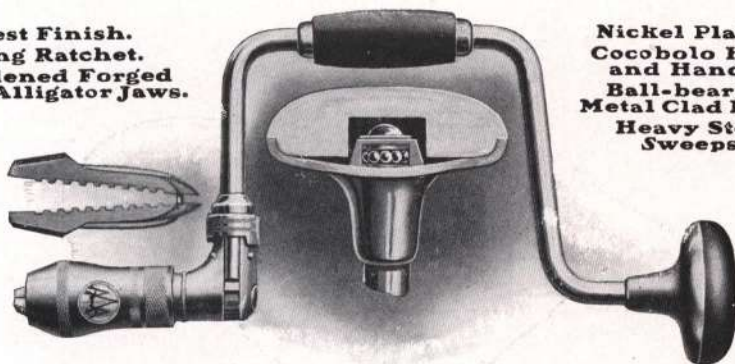

**Nickel Plated.  
Cocobolo Head  
and Handle.  
Ball-bearing  
Metal Clad Head.  
Heavy Steel  
Sweeps.**

Same quality of workmanship as described above, and same tool in all respects, save in the ratchet, which is not closed.

No. 406.	6-inch	.....	per dozen,	\$28 50
No. 408.	8-inch	.....	"	29 00
No. 410.	10-inch	.....	"	30 00
No. 412.	12-inch	.....	"	31 50
No. 414.	14-inch	.....	"	35 00

½ DOZEN IN METAL-EDGE BOXES. 6 DOZEN IN CASES.

APPROXIMATE WEIGHT OF 10-INCH SIZE IS 31 LBS. PER DOZEN.

**ATKINS RATCHET BRACES.**

**Best Finish  
Ring Ratchet.  
Cast Steel  
Alligator Jaws.  
Steel Sockets.**

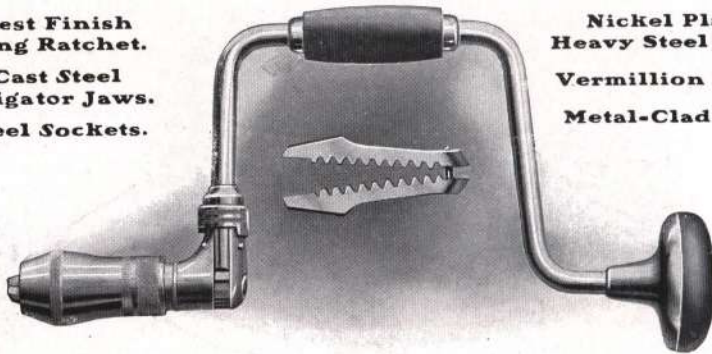

**Nickel Plated  
Heavy Steel Sweep.  
Vermillion Wood.  
Metal-Clad Head.**

Same quality of workmanship as described on the preceding page.

Not ball-bearing. Will hold any size of bit or small size drill.

No. 308.	8-inch	..... per dozen,	\$21 50	No. 312.	12-inch	..... per dozen,	\$23 50
No. 310.	10-inch	.....	22 50	No. 314.	14-inch	.....	25 50

**Same, Except Not Metal-Clad, Head Fastened to Quill  
With Three Screws.**

No. 2308.	8-inch	..... per dozen,	\$20 50	No. 2312.	12-inch	..... per dozen,	\$22 50
No. 2310.	10-inch	.....	21 50	No. 2314.	14-inch	.....	24 50

**Same Model of Brace as Shown in Above Cut, Except That the  
Head and Handle are of Ebonized Hardwood, With Other  
Detail of the Fittings the Same. Not Ball-Bearing.**

No. 508.	8-inch	..... per dozen,	\$18 00
No. 510.	10-inch	.....	19 00
No. 512.	12-inch	.....	20 50

**Same, Except Not Metal-Clad, Head Fastened to Quill  
With Three Screws.**

No. 2508.	8-inch sweep	..... per dozen,	\$17 00
No. 2510.	10-inch sweep	.....	18 00
No. 2512.	12-inch sweep	.....	19 50

**Same as Last, Except Finely Polished.**

No. 608.	8-inch	..... per dozen,	\$15 00
No. 610.	10-inch	.....	16 00
No. 612.	12-inch	.....	17 50

All nickel plated and better grades of polished braces are wrapped singly in papers and packed in metal-edge jute board boxes.

ALL ABOVE ARE PACKED 1/2 DOZEN IN A BOX AND 6 DOZEN IN CASES.  
APPROXIMATE WEIGHT OF 10-INCH SIZE IS 30 LBS. PER DOZEN.



**ATKINS RATCHET BRACES.**

**Best Finish.  
Pawl Ratchet.  
Hardened Forged  
Steel Alligator  
Jaws.**

**Nickel Plated.  
Cocobolo Head  
and Handle.  
Ball Bearing  
Head.**

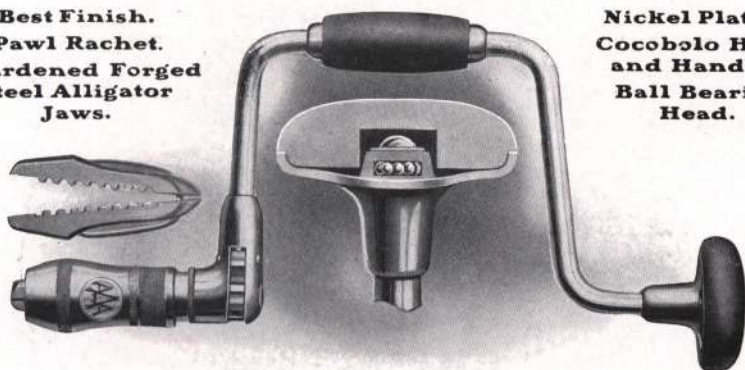

These Braces are made of the best material and workmanship, heavy and strong. Will hold all sizes of bits. Has simple ratchet movement, positive and sure.

- |           |                       |         |           |                        |       |
|-----------|-----------------------|---------|-----------|------------------------|-------|
| No. 1008. | 8-inch.....per dozen, | \$20 00 | No. 1012. | 12-inch.....per dozen, | 21 50 |
| No. 1010. | 10 inch.....          | 20 60   | No. 1014. | 14-inch.....           | 24 00 |

**Same With Metal-Clad Ball Bearing Head.**

- |           |                        |         |           |                          |         |
|-----------|------------------------|---------|-----------|--------------------------|---------|
| No. 1108. | 8-inch sweep per doz., | \$21 00 | No. 1112. | 12-inch sweep, per doz., | \$22 50 |
| No. 1110. | 10-inch sweep          | 21 60   | No. 1114. | 14-inch sweep,           | 25 00   |
- Same pattern Brace, nickel plated. Ebonized hardwood head and handle. Alligator Jaws.
- |          |                       |         |          |                        |         |
|----------|-----------------------|---------|----------|------------------------|---------|
| No. 908. | 8-inch.....per dozen, | \$12 50 | No. 912. | 12-inch.....per dozen, | \$13 50 |
| No. 910. | 10-inch.....          | 13 00   |          |                        |         |
- Same pattern Brace. Polished. Stained Hardwood head and handle.
- |          |                        |        |          |                        |        |
|----------|------------------------|--------|----------|------------------------|--------|
| No. 808. | 8-inch.....per dozen,  | \$8 50 | No. 812. | 12-inch.....per dozen, | \$9 50 |
| No. 810. | 10-inch.....per dozen, | 9 00   |          |                        |        |

**High Grade Straight Braces.**

OUR FINEST QUALITY

Finely Nickeled. Cocobolo Head and Handle. Ball Bearing. Metal-Clad Head. Hardened Forged Steel Alligator Jaws.

- |         |                   |            |         |
|---------|-------------------|------------|---------|
| No. 21. | 8-inch sweep..... | per dozen, | \$10 00 |
| No. 22. | 10-inch ".....    | "          | 10 50   |
| No. 23. | 12-inch ".....    | "          | 11 00   |
| No. 24. | 14-inch ".....    | "          | 13 00   |

**Similar to Same. Not Ball-Bearing, or Metal-Clad. Cast Alligator Jaws.**

- |          |                          |        |          |                           |        |
|----------|--------------------------|--------|----------|---------------------------|--------|
| No. 233. | 6-inch sweep, per dozen, | \$7 75 | No. 235. | 10-inch sweep, per dozen, | \$8 20 |
| No. 234. | 8-inch sweep,            | 7 75   | No. 236. | 12-inch sweep,            | 8 50   |
- Low Price. Plain polished. Stained head and handle.
- |         |  |        |          |                        |        |
|---------|--|--------|----------|------------------------|--------|
| No. 08. | 8-inch.....per dozen,  | \$3 80 | No. 010. | 10-inch.....per dozen, | \$4 00 |
| No. 5.  | Plain finish. 3/8-inch steel sweep. Square hole socket with thumb screw, Ball Brace..... |        |          |                        | \$1 70 |

Good Braces are Packed 1/2 Dozen in Metal-Edge Boxes, and Cheap Finished Ones in Strong Paper Packages



**ATKINS RATCHET BRACES.**

**Good Finish.  
Ring Ratchet.  
Cast Steel.  
Alligator Jaws.**

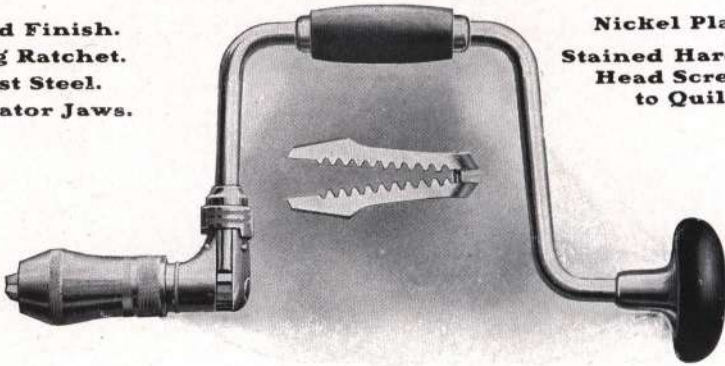

**Nickel Plated.  
Stained Hardwood  
Head Screwed  
to Quill.**

Strong, well made tool, with same quality of material found in better grades.  
Fitted with steel chuck that will hold all sizes of square shank bits  
and small size round shank drills.

No. 2708.	8-inch sweep	per dozen,	\$14 65
No. 2710.	10-inch sweep	"	15 25
No. 2712.	12-inch sweep	"	16 00

**Same, With Small Size Quill Under the Head. Nickerled.**

No. N 708.	8-inch sweep	per dozen,	\$13 25
No. N 710.	10-inch sweep	"	14 00
No. N 712.	12-inch sweep	"	14 75

**Same as Last, Except Polished.**

No. 708.	8-inch sweep	per dozen,	\$11 75
No. 710.	10-inch sweep	"	12 50
No. 712.	12-inch sweep	"	13 25

**STRAIGHT BRACES.**

**Cast Steel  
Alligator Jaws.**

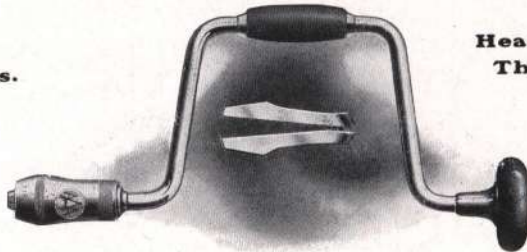

**Head secured by  
Three Screws.**

Finely nickel plated. Ebonized hardwood head and handle.

No. 34.	8-inch	per dozen,	\$6 00	No. 36.	12-inch	per dozen,	\$6 50
No. 35.	10-inch	"	6 25				

**Same, Finely Polished.**

No. 37.	8-inch	per dozen,	\$5 00	No. 39.	12-inch	per dozen,	\$5 50
No. 38.	10-inch	"	5 25				

1/2 DOZEN IN METAL-EDGED BOXES.

**ATKINS UNIVERSAL BREAST DRILL.**

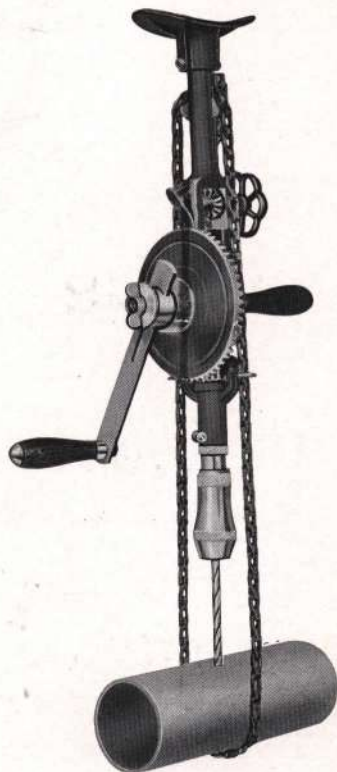
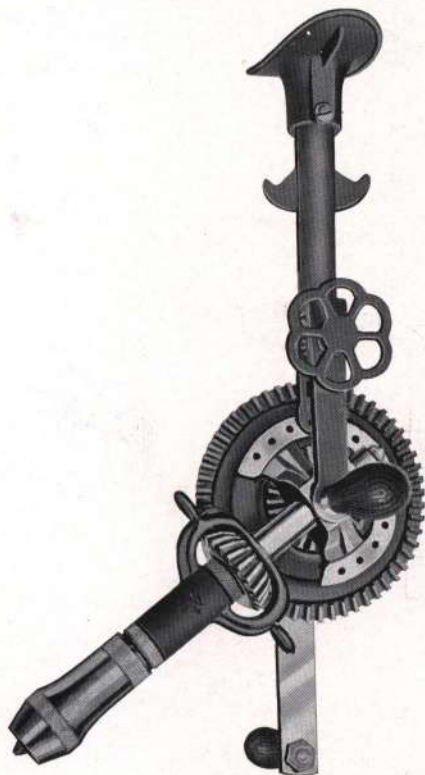

In placing this tool before the mechanic it can be safely asserted that it has features that cannot be found in any other drill in the market.

This drill has a **CHAIN FEED ATTACHMENT** which is operated by the supporting handle, allowing pipes and similar articles to be drilled with perfect ease.

It can be **ADJUSTED TO ANY ANGLE**, making it indispensable for working between girders and ceiling joists and for such work has a **SCREW FEED**.

When limited space does not allow a full turn of the handle, the **RATCHET** can be used.

It has **TWO SPEED GEARS** which can be readily changed. The sweep of the handle is also adjustable.

From the features stated, it will be readily seen that this drill exceeds in usefulness any other drill heretofore brought before the mechanic, and is the most improved tool of its kind.

Machine-cut gears. Cocobolo handles. Adjustable crank. Nickel-plated chuck, fitted with forged steel alligator jaws, that will firmly hold both round and square shank drills. Double ball bearing socket. All well finished. Each tool is fitted with the special chain feed attachment, together with 4½ feet of strong chain.

The 3-jaw chuck will hold round shank drills from 0 to ½-inch.

Price, fitted with 2-jaw chuck..... each \$ 8 50  
 Price, fitted with 3-jaw chuck..... each 11 00

One each in metal-edged box; 2 dozen in cases. Approximate weight complete is 7½ lbs. each.

## ATKINS ECLIPSE BREAST DRILL.

**Designed for Hard Service**



A strong, well finished tool. Nickel-plated. Breastplate and large gear painted red. Double gear. Adjustable crank of heavy pattern. Steel chuck fitted with alligator hardened forged steel jaws that will hold small size round shank drills or wood bits of all kinds.

No. 52.	With 2-jaw chuck.....	per dozen,	\$33 00
No. 52R.	Same, fitted with ratchet attachment.....	“ “	39 00

### Same, Fitted with an Oval Taper Drill Chuck.

The simplest and strongest manner of holding a drill.

No. 50.	Price, with oval taper chuck.....	per dozen,	\$36 00
No. 50R.	Same, fitted with ratchet attachment,.....	“ “	42 00

PUT UP 1-12 DOZEN IN BOX.

### DRILLS

Per set of 6, one each with oval taper shanks, to fit above, 5-32, 7-32, 9-32, 11-32, 13-32, 15-32 inch,.....\$2 50





# Saw Makers' Tools and Saw Mill Specialties

To accomplish the best results a workman must have suitable tools, and mills should be equipped with the latest improved appliances.

Our practical experience and knowledge of the requirements of saw makers and wants of the mills enable us to furnish a line of Tools and Mill Specialties adapted to meet their wants.

We invite your attention to the following list of Tools and Mill Specialties:

## STANDARD WIRE GAUGES.

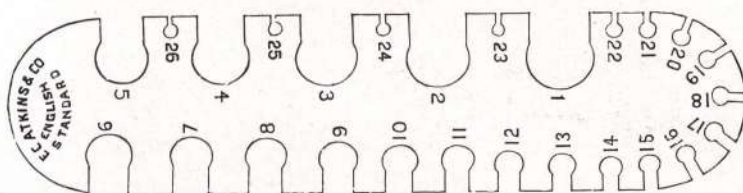

Small Gauges, Nos. 1 to 26 ..... Each, \$1 25  
 Round Wire Gauges ..... " 1 00

## IMPROVED SPEED INDICATOR.

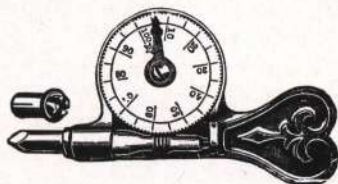

Correct and reliable. This instrument is very useful for accurately giving the speed of any machine or shaft when in motion. It is very important that the exact speed of saws be given, and with the Speed Indicator there can be no mistake. Every mechanic should have one.

Sent by mail, prepaid, with cap, for \$0.75.

**ATKINS SAW MAKERS' TOOLS.**

**ANVILS, STEEL FACED.**



Anvils weighing less than 180 pounds ..... Price per pound, \$0 15  
 Anvils weighing 180 pounds or over ..... " " 18  
 We keep in stock Anvils 10x6 face, 86, 110, 145 pounds; 12x6, 250 pounds.



**ROUND FACED HAMMER.**

Price, per pound, \$0.60  
 Furnished any weight desired.

**SQUARE FACE HAMMER.**

Price, per pound, \$0.60  
 Furnished any weight desired.



**STRAIGHT EDGE.**

Price, per foot, \$1.00

**LEVELING TABLE.**



12 inches wide, 7 feet long, price, \$18.00

## ATKINS LEVELING BLOCK.

Surfaced on Both Sides.

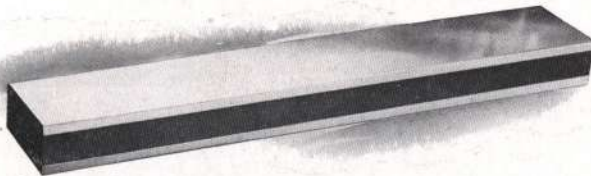

12 inches wide, 2 inches thick.....	Per lineal foot, \$6 00
12 " " 2½ " " .....	" " 7 50
12 " " 3 " " .....	" " 9 00
12 " " 3½ " " .....	" " 10 50
12 " " 4 " " .....	" " 12 00

Other widths at proportionate prices.

## CIRCULAR AND MILL SAW SETS.

Made to suit saws of different sizes.



Large, for Circular Saws, double handle .....	each, \$2 25
Small, for Band Saws, single handle.....	" 1 50

### SHINGLE SAW SET.

**For Heading, Shingle or Small Saws.**



Drop Forged Tool Steel. List price per doz., \$9 00

## BAR SWAGES AND HAMMER.

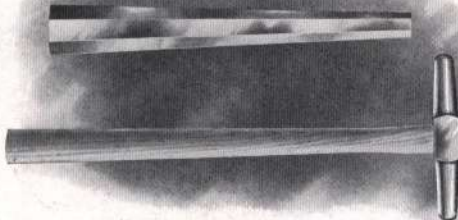

Hammer.....	List, each, ¾-inch, \$1.50; 7/8-inch, \$1.80; 1-inch, \$2 25
Swage Bars, No. 1, eight or six-sided, 11 x 1 x ½-inch.....	List, each, 3 75
" No. 2, " " 11 x 1¼ x 5/8 " .....	" 4 50
" No. 3, " " 11 x 1½ x ¾ " .....	" 5 25
" No. 4, " " 11 x 1¾ x 7/8 " .....	" 6 00

Every sawyer or filer should have one of these swages and hammers for drawing out short teeth, or swaging saws, before using the regular swage or upset.



**ATKINS SWAGES.**



**ATKINS UPSET SWAGES.**

No. 0, for large Circular Saws, from 5 to 10 gauge.....	\$3 00
No. 1, for large Circular Saws, from 8 to 12 gauge.....	2 75
No. 2, for small Circular and Mill Saws of thinner gauge.....	2 25
No. 3, for small Circular Saws.....	1 75



**ATKINS BAND AND CYLINDER SAW SWAGE.**

No. 2 Swage, for Band and Cylinder Saws, \$2.25.

**MIXTER'S DUPLEX SWAGES.**



**MIXTER'S PATENT SWAGES.**

No. 3 Duplex Swage, largest size, for saws of from 5 to 10 gauge.....	\$7 00
No. 2 Duplex Swage, medium size, for saws of from 8 to 12 gauge.....	6 00
No. 1 Duplex Swage, for all thinner gauges.....	5 00
No. 0 Duplex Swage, for small, thin saws.....	4 00

**ATKINS NEW IDEAL SWAGE.  
Nos. 0 and 1.**

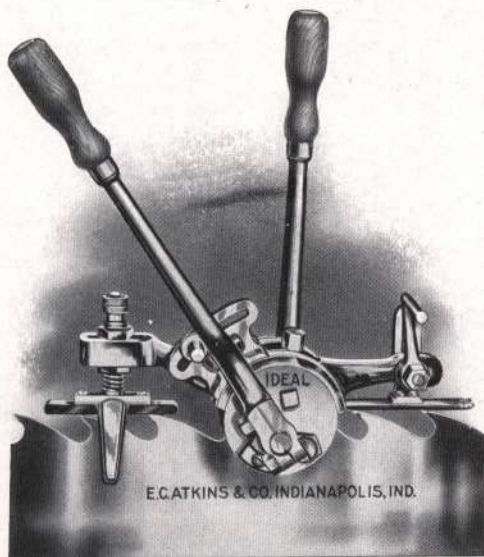

As the result of years of experiment and experience, we are pleased to present Atkins New Ideal Saw Swage. This device overcomes all former difficulties and not only produces a perfect point ready for the shaper, but is of exceedingly simple construction and adjustment. It can be adjusted to swage any shape tooth by moving the block or body of the swage without changing the relation of the position of the block to the position of the die and anvil.

Makers of Swages have been striving to attain this feature for years. We have solved it first. The principle under which the New Improved Swage operates will be clear to you by referring to the X-Ray picture on page 212. Please note the few working parts which have been made strong and are re-inforced so as to prevent wear and breakage. From the standpoints of efficiency, durability and economy the Atkins Ideal Swage leads them all.

The Swage is handsomely nickel-plated and buffed, and will not rust easily. Duplicate parts may be secured at a nominal cost, (see page 212.)

**List Prices.**

No. 0	For Band Re-saws 17 gauge and thinner.....	\$37 50
No. 1	For Log Band Saws and Band Re-saws 14 to 17 gauge .....	37 50

## ATKINS NEW IDEAL SWAGE.

### Nos. 2, 3, 4, 5, 6 and 7.

**FOR CIRCULAR, SHINGLE, BAND AND GANG SAWS.**

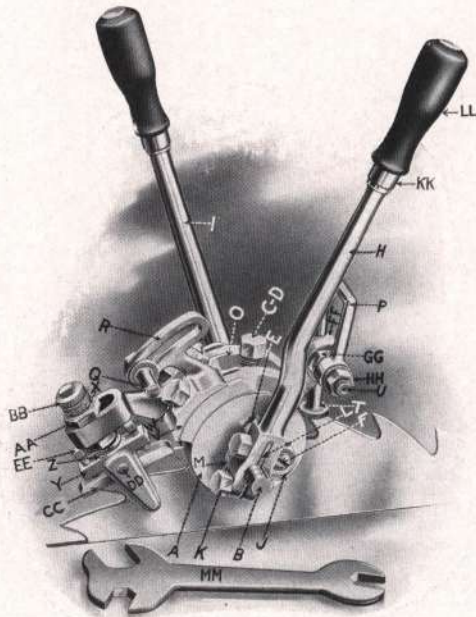

The above Swage is similar to the New Ideal Nos. 0 and 1, but is designed for use on Circular Saws.

It is the result of years of experiment and experience and overcomes all difficulties which formerly existed, and while constructed along simple lines has the advantage of producing a perfect point ready for the shaper with the least possible adjustment.

It has the advantage of being adjusted to swage any shape tooth by simply moving the block or body of the swage without changing the relation of the position of the block to the position of the die and anvil.

This is a feature that has been attempted by all other swage manufacturers but has never been secured before.

The swage is handsomely nickel-plated and buffed, and duplicate parts may be secured at a nominal cost. (See page 212.)

#### List Prices.

No. 2	For Circular Saws 8 to 10 gauge .....	\$45 00
No. 3	For Circular Saws 6 to 8 gauge .....	52 50
No. 4	For Shingle and other thin Circular Saws 14 to 19 gauge .....	37 50
No. 5	For Band and Gang Saws 12 to 14 gauge (Gangs not less than 1½-inch points) .....	45 00
No. 6	For Band Saws 12 and 13 gauge, large tooth, heavy duty .....	52 50
No. 7	For Circular Saws 12 to 14 gauge, gullet not less than ⅜-inch diameter .....	37 50



**ATKINS IDEAL SWAGE.**

**WITH BENCH ATTACHMENT.**

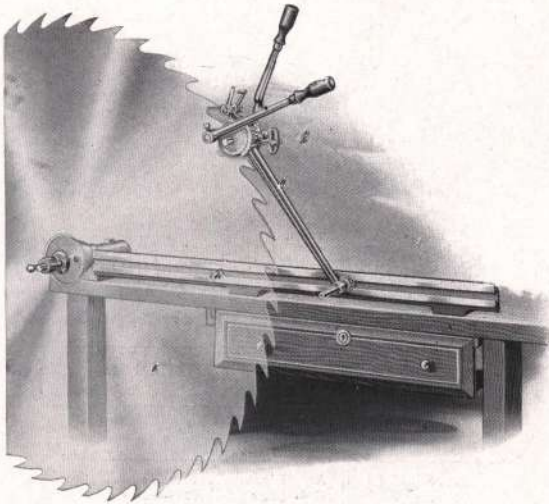

For greater convenience, economy and the execution of more perfect work, we have fitted the Ideal Swage for Circular Saws shown on page 209, with a bench attachment.

The construction of same is shown very plainly in the above illustration.

It may be fastened to any ordinary work bench, and being equipped with a cone attachment will accommodate any size of hole.

In order to operate this Swage, it is merely necessary to move the supporting bar to the right or left until in the desired position, after which the Swage may be operated in the regular way by moving the Saw forward after each tooth is swaged.

This attachment assists in jointing the teeth uniformly, furnishes a convenient and economical attachment, and is much easier on the operator, enabling him to perform this operation with greater speed.

**List Prices.**

No. 0 Complete with bench attachment.....	\$42 75
No. 1 Complete with bench attachment.....	42 75
No. 2 Complete with bench attachment.....	50 25
No. 3 Complete with bench attachment.....	57 75
Bench attachment, when furnished alone.....	7 50

ATKINS NEW IDEAL SWAGE.

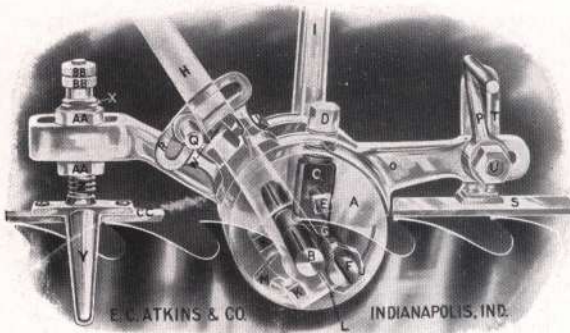

In putting the New Ideal Swage on the market we feel assured that we have at last reached the climax of swage perfection. The material and workmanship embodied in the New Ideal Swage are the best that money can buy, and along with the principles which have been brought out, not only by many years of saw manufacturing, but by the actual use in the mills, we know that the results can not be anything but the most satisfactory.

The principle of the New Ideal Swage is such that the working corner of the anvil is at the exact center of operation, so that when the point of the tooth is placed

exactly at the corner of the anvil and the block is rolled forward or back in the saddle, to accommodate a slender or blunt tooth, the relation of the point of the tooth to the anvil always remains the same, and in the same manner the relation of the die to the anvil remains the same, thereby allowing an easy adjustment to the most inexperienced operators.

PARTS FOR NEW IDEAL SWAGES, Nos. 0 and 1.		PARTS FOR NEW IDEAL SWAGES, Nos. 2, 3, 4, 5, 6 and 7.			
NAME OF PART.	Price Each, Net.	NAME OF PART.	PRICE EACH, NET.		
			2 and 5	3 and 6	4 and 7
A Block.....	\$12 00	A Block.....	\$13 00	\$14 00	\$12 00
B Die.....	2 00	B Die.....	2 00	2 50	2 00
C Anvil.....	1 00	C Anvil.....	1 00	1 00	1 00
D Anvil Screw.....	1 00	D Anvil Screw.....	1 00	1 00	1 00
E Anvil Set Screws (2).....	25	E Anvil Set Screws, (2).....	25	35	25
F Stationary Clamp Screw.....	1 00	F Stationary Clamp Screw.....	1 00	1 00	1 00
G Movable Clamp Screw.....	1 00	G Movable Clamp Screw.....	1 00	1 00	1 00
H Die Lever.....	2 00	H Die Lever.....	2 50	3 00	2 00
I Clamping Lever.....	2 00	I Clamping Lever.....	2 00	2 50	2 00
J Lock Nut for Stationary Clamp Screw.....	25	J Lock Nut for Stationary Cl. Screw.....	25	25	25
K Cap Screws for Die Lever, (2).....	15	K Cap Screws for Die Lever, (2).....	20	25	15
L Key for Die Lever.....	10	L Key for Die Lever.....	10	15	10
M Lock for Die Lever.....	15	M Lock for Die Lever.....	25	25	15
N Set Screw for Clamping Lever.....	10	N Set Screw for Clamping Lever.....	10	10	10
O Saddle.....	2 00	O Saddle.....	3 00	4 00	2 00
P Die Opening Stop.....	50	P Die Opening Stop.....	50	50	50
Q Die Finishing Stop.....	50	Q Die Finishing Stop.....	50	50	50
R Die Finishing Stop Bracket.....	50	R Die Finishing Stop Bracket.....	75	1 00	50
S Rear Rest Plate.....	50	S Bushings, (2).....	50	60	40
T Rear Rest.....	50	T Rear Rest.....	50	50	50
U Stud for Rear Rest, including Nuts.....	50	U Stud for Rear Rest, including Nuts. Not used on No. 4.....	1 00	1 25	1 00
V Saddle Cap.....	25	V Saddle Cap.....	35	50	25
W Cap Screws for Saddle, (2).....	10	W Cap Screws for Saddle, (2).....	10	10	10
X Sleeve.....	50	X Sleeve.....	50	50	50
Y Front Fork Rest.....	75	Y Front Fork Rest.....	1 00	1 00	75
Z Spring for Front Fork.....	15	Z Spring for Front Fork.....	20	25	15
AA Lock Nuts for Sleeve, (2).....	25	AA Lock Nuts for Sleeve, (2).....	25	25	25
BB Lock Nuts for Front Fork, (2).....	25	BB Lock Nuts for Front Fork, (2).....	35	40	25
CC Plate for Front Fork.....	50	CC Plate for Front Fork.....	60	60	50
DD Button Head Screws, (2).....	10	DD Rivet.....	10	10	10
EE Indicator.....	25	EE Adjusting Screws for Front Fork Plate, (2).....	15	15	15
FF Ferrules, (2).....	10	FF Collar.....	25	25	25
GG Wood Handles, (2).....	15	GG Lock Nut for Rear Stud.....	15	15	15
HH Wrench.....	75	HH Lock Nut for Die Opening Stop.....	10	10	10
II Bushings, (2).....	50	II Button Head Screws, (2).....	10	10	10
		JJ Indicator.....	25	25	25
		KK Ferrules, (2).....	10	10	10
		LL Wood Handles, (2).....	20	25	15
		MM Wrench.....	1 00	1 25	75

N. B.—In ordering parts be sure to give the Number of Swage and the Letter indicating the part desired. Prices include postage when sent by mail.



**VICTOR SWAGE.**

**For Circular, Band, Gang, Mulay, Shingle, Lath, and Re-Saws.**

One of the most satisfactory Lever Swages made. Well known among mill men. Work unequalled. Satisfaction guaranteed.

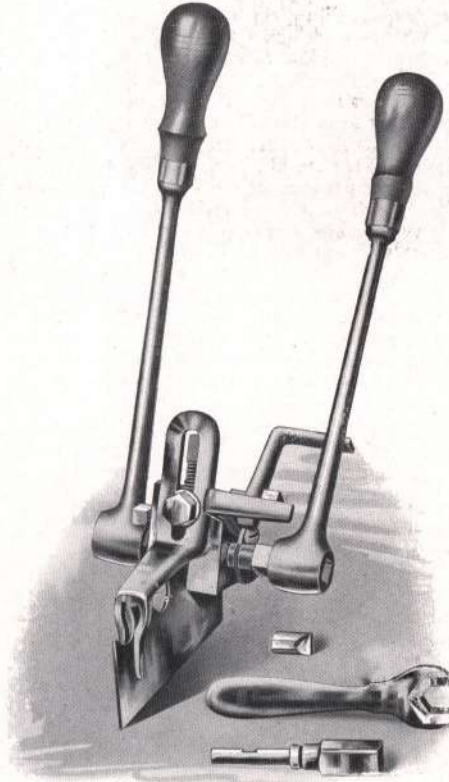

Price of Victor Swage, any size, \$37.50.

We manufacture the Victor Swage in eight sizes for the various classes and gauges of saws, as follows:

- |   |  |
|---|--|
| No. 1, for Circular Saws 6 to 8 gauge.        | No. 6B, for Band and Gang Saws 14 to 16 gauge. |
| No. 2, for Circular Saws 8 to 10 gauge.       | No. 6C, for Circular Saws 14 to 16 gauge.      |
| No. 3, for Gang and Mulay Saws 9 to 13 gauge. | No. 7, for Band Saws 18 and 19 gauge.          |
| No. 4, for Circular Saws 10 to 13 gauge.      | No. 8, for Band Saws 19 gauge and thinner.     |
| No. 5, for Band and Gang Saws 16 to 18 gauge. |  |

In ordering give kind and gauge of saw. In ordering Dies give the number on the swage.  
 Extra Dies for Nos. 3, 4, 5, 6, 7 and 8..... Each, \$0 75  
 Extra Dies for Nos. 1 and 2..... " 1 00

**Two Dies go with Each Swage.**

These Dies are not interchangeable, but must always be ordered for corresponding number of Swage.



## THE PRIBNOW SWAGE.

The highest efficiency of this Eccentric Die Swage was reached by adopting a series of anvils and special shaped dies.

The anvil corners are scribed and numbered to agree with notches in the combination gauge (see description below) which affords absolute positive adjustments and quick change from one style of saw or shape of tooth to another. The dies are made in different styles best suited for the different classes of work. Other special features are: simple construction, which affords strength, durability, great speed and ease of operation.

They have passed the experimental stage and are endorsed by a number of the best filers as the most complete and perfect working tool on the market. Made in nine styles, suited for the different kinds of saws. Strength and workmanship guaranteed.

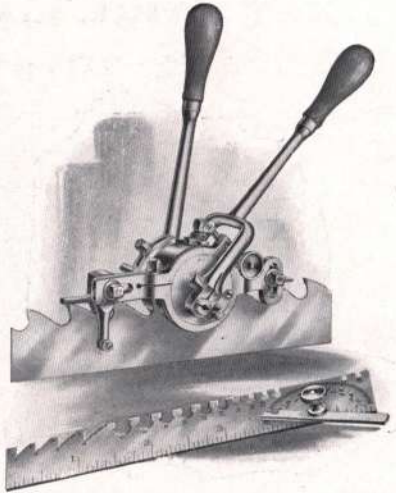

No. 1	For Circular Saws from 5 to 10 gauge, $\frac{3}{8}$ -inch die.....	\$54 00
	Price includes Wrench and Set Gauge only.	
No. 2	For Circular and Heavy Band Saws, 8 to 13 gauge, $\frac{1}{4}$ -inch die.....	57 00
	Price includes Wrench and Anvil Grinding Gauge.	
No. 3	For Circular and Heavy Band Saws, 10 to 14 gauge, $\frac{3}{8}$ -inch die .....	54 00
No. 4	For Band, Gang, Shingle and Heading Saws, 12 to 16 gauge, $\frac{1}{2}$ -inch die....	52 50
No. 5	For Band Re-saws, Shingle and Heading Saws, 15 to 19 gauge, $\frac{1}{2}$ -inch die...	48 75
No. 6	For Band Re-saws, Shingle and Heading Saws, 16 to 20 gauge, $\frac{3}{4}$ -inch die...	45 00
No. 7	For Saws 19 gauge and thinner .....	37 50
	Price includes Wrench only.	
No. 8	1910 Model, Single Die Lever Style. For Circular and Heavy Band Saws, 10 to 14 gauge, $\frac{1}{2}$ -inch die.....	54 00
No. 9	1910 Model, Single Die Lever Style. For Circular and Band Saws, 12 to 16 gauge, $\frac{1}{2}$ -inch die.....	52 50
	Nos. 3, 4, 5, 6, 8 and 9 prices include Wrench, Combination and Anvil Grinding Gauges.	
No. 1	Pribnow Combination Gauge, 6-inch.....	3 75
No. 2	Pribnow Combination Gauge, 5-inch.....	3 00

### Pribnow Swage Parts.

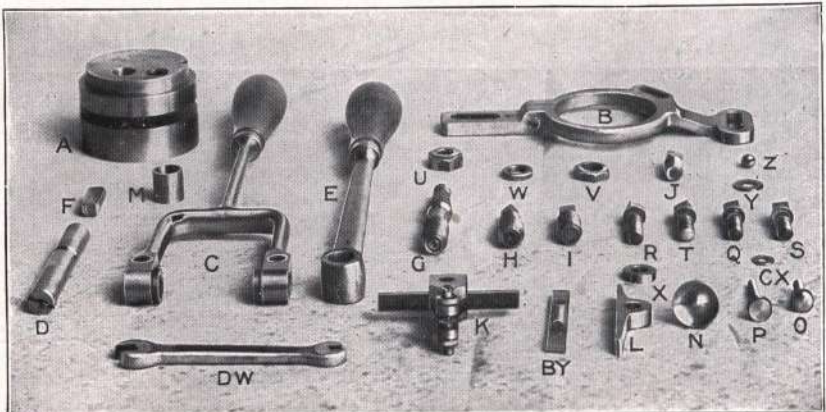

See following page for description and net prices.

## NET PRICE LIST OF PARTS FOR THE PRIBNOW SWAGE.

Stock Letter.	DESCRIPTION.	Style No. 1, Each.	Style No. 2, Each.	Style No. 6 and 7, Each.	Style No. 8, Each.	Style No. 9, Each.
A	Head with Hardened Bearings.....	\$12 00	\$12 00	\$ 8 00	\$10 00	\$10 00
B	Guide Frame.....	....	4 50	2 00	4 00	4 00
C	Die Lever.....	2 00	2 00	1 50	1 50	1 50
D	Die, Mild Eccentric.....	2 00	2 00	1 00	1 50	1 25
DD	Die, Medium Eccentric.....	2 00	2 00	1 00	1 50	1 25
DDD	Die, Deep Eccentric.....	2 00	2 00	1 00	1 50	1 25
	<small>Dies are furnished one-sided, two-sided or oval as required.</small>					
E	Clamping Lever.....	1 75	1 75	1 00	1 25	1 25
F	Anvils, Double-ended, marked "1 and 2" or "3 and 4".....	1 00	1 00	50	75	75
	<small>Anvils are also furnished with both ends fitted and marked alike.</small>					
G	Clamping Screw, Right Hand or Left Hand	1 25	1 25	75	1 00	1 00
H	Stationary Clamping Screw, Right Hand or Left Hand.....	75	75	50	50	50
I	Anvil Adjusting Screw.....	75	75	50	50	50
J	Anvil Set Screw.....	25	25	20	25	25
K	Front Guide, complete.....	....	2 00	1 25	1 75	1 75
L	Rear Tooth Rest.....	....	75	30	50	50
M	Hardened Steel Die Bearings, per pair....	1 25	1 25	75	1 00	1 00
N	Die Lever Stops, Front and Back.....	50	50	25	25	25
O	Screws for Die Lever Stop.....	15	15	10	15	15
P	Die Adjuster, (Slotted Bracket).....	1 50	1 50	1 00	1 75	1 50
Q	Shoulder Bolt for Guide Frame.....	....	25	15	20	20
R	Shoulder Bolt for Guide Fork and Tooth Rest.....	....	25	10	15	15
S	Grip Bolt for Die.....	75	75	25	40	40
T	Nuts for Grip Bolt and Clamp Screw, Right Hand or Left Hand.....	20	20	10	15	15
U	Nut for Rear Tooth Rest.....	....	25	....	25	25
V	Shoulder Bolt for Die Bracket.....	20	20	15	20	20
W	Set Screw for Stationary Clamp Screw....	10	10	10	15	15
X	Washer for Die Adjuster.....	10	10	10	10	10
Y	Washer for Front Fork and Tooth Rest....	....	05	05	05	05
Z	Die Lever Latch.....	25	25	15	25	25
AZ	Pin for Tooth Rest.....	....	05	05	05	05
BY	Front Tooth Rest.....	....	60	40	50	50
CX	Bracket for Die Lever Stop.....	....	1 00	75	1 00	1 00
DW	Wrench.....	50	50	40	50	50
EV	Cap Screws for Bracket.....	05	05	03	05	05
FU	Cap Screw for Die Lever Latch.....	05	05	03	05	05
GT	Anvil Grinding Gauge.....	1 00	1 00	75	1 00	1 00
HS	Bracket.....	3 00	....	....	....	....
IR	Set Gauge.....	50	....	....	....	....
JQ	Shoulder Bolt for Back Stop.....	20	....	....	....	....
KP	Washer, Curved Seat for Back Stop.....	25	....	....	....	....
LO	Back Stop for Die Lever.....	50	....	....	....	....
MN	Slotted Bench Casting.....	1 00	....	....	....	....
NM	Bench Casting, complete.....	5 00	....	....	....	....

N. B.—In ordering Parts be sure and give the Style Number of the Swage and also the Stock Letter indicating the Part required. Prices include postage when sent by mail.



## NET PRICE LIST OF PARTS FOR THE PRIBNOW SWAGE.

Stock Letter.	DESCRIPTION.	Style No. 3, Each.	Style No. 4, Each.	Style No. 5, Each.
A	Head with Hardened Bearings.....	\$10 00	\$10 00	\$ 8 00
B	Guide Frame.....	4 00	4 00	3 00
C	Die Lever.....	3 50	3 00	2 50
D	Die, Mild Eccentric.....	2 00	1 75	1 50
DD	Die, Medium Eccentric.....	2 00	1 75	1 50
DDD	Die, Deep Eccentric.....	2 00	1 75	1 50
	<small>Dies are furnished one-sided, two-sided or oval as required.</small>			
E	Clamping Lever.....	1 50	1 50	1 00
F	Anvils, Double-ended, marked "1 and 2" or "3 and 4" .. <small>Anvils are also furnished with both ends fitted and marked alike.</small>	1 75	75	75
G	Clamping Screws, Right Hand or Left Hand.....	1 00	1 00	75
H	Stationary Clamping Screw, Right Hand or Left Hand....	75	75	50
I	Anvil Adjusting Screw.....	60	60	50
J	Anvil Set Screw.....	50	50	40
K	Front Guide, complete.....	1 75	1 75	1 50
L	Rear Tooth Rest.....	50	50	50
M	Hardened Steel Die Bearings, per pair.....	1 00	1 00	75
N	Knurled Thumb Nut.....	20	20	20
O	Screw for Thumb Nut.....	25	25	25
P	Die Lever Adjusting Screw.....	25	25	25
Q	Shoulder Bolt for Guide Frame.....	20	20	15
R	Shoulder Bolt for Front Guide Fork.....	20	20	15
S	Grip Bolts for Die Lever.....	25	25	25
T	Shoulder Bolt for Rear Tooth Rest.....	20	20	15
U	Nuts for Clamping Screw, Right Hand or Left Hand.....	15	15	10
V	Jam Nut for Anvil Adjusting Screw.....	20	20	20
W	Jam Nut for Stationary Clamp Screw.....	10	10	10
Y	Washers for Guide.....	05	05	05
Z	Screws for Head.....	05	05	05
AZ	Pin for Tooth Rest.....	05	05	05
BY	Front Tooth Rest.....	50	50	50
CX	Washer.....	05	05	05
DW	Wrench.....	50	50	50
EV	Die Lever Stop.....	50	50	50
FU	Shoulder Bolt for Die Lever Stop.....	20	20	20
GT	Washer for Die Lever Stop.....	10	10	10
HS	Nut for Grip Bolt.....	20	20	15
IR	Anvil Grinding Gauge.....	1 00	1 00	1 00

N. B.—In ordering Parts, be sure and give the Style Number of the Swage and also the Stock Letter indicating the Part required. Prices include postage when sent by mail.



**THE PRIBNOW PATENT SWAGE SHAPER.**

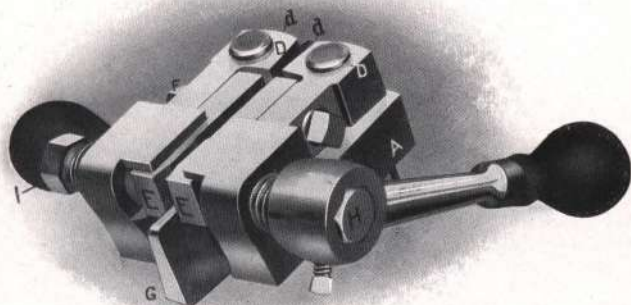

**Nos. 1, 2 and 3.**

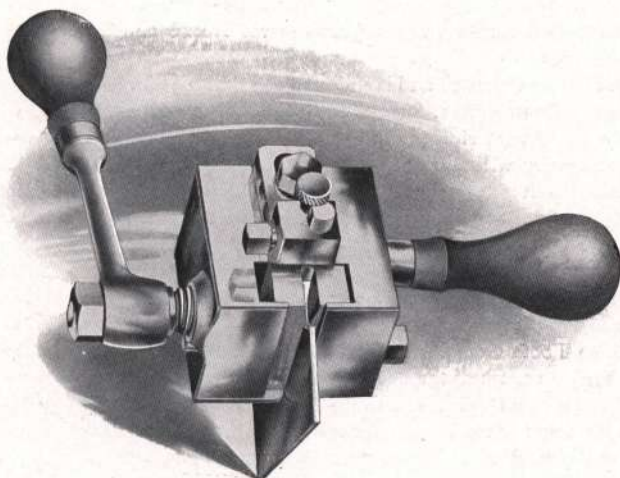

**No. 4.**

**Pribnow Shapers Do the Most Perfect Work of Any on the Market.**

The advantages to be obtained by the use of the Pribnow Shaper are obvious. It is the invention of an expert, and has the endorsement of experts and users of Circular, Gang and Band Saws everywhere.

**List Prices.**

No. 1	For Band and Gang Saws from 12 to 16 gauge .....	\$30 00
No. 2	For Re-Saw and Shingle Saws from 16 to 24 gauge .....	30 00
No. 3	Special, for Large Band Saws from 6 to 12 gauge .....	30 00
No. 4	For Circular Saws from 6 to 10 gauge .....	37 50

For Net List of Parts see page 219.

## THE NEW PRIBNOW IMPROVED PATENT SWAGE SHAPER.

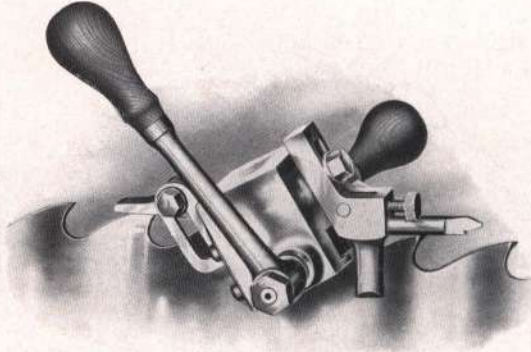

**Nos. 5 and 6.**

This device contains all the best features of the Nos. 5 and 6 Shapers with a number of important advantages.

It has been thoroughly tested and is endorsed as a decided improvement by many expert filers.

Hereafter all orders for Nos. 5 and 6 Pribnow Shapers will be supplied with the new tool.

The New Tooth Gauge Holder will fit the Nos. 5 and 6 Shapers as they were formerly made. The Back Rest Bracket will also fit by drilling an extra hole in the block. Should you wish to avail yourself of this new device you may do so by ordering the new style Tooth Gauge Holder and Back Rest Bracket only and placing them on the old style Shaper as indicated above.

The advantages of the New Nos. 5 and 6 are as follows:

**FIRST**—The Tooth Gauge Holder straddles the Saw and guides the tooth gauge exactly over the tooth to be operated upon.

**SECOND**—The Tooth Gauge is long and rests on two teeth, making a positive guide for the tooth to enter the stop notch as the Shaper slides along the Saw.

**THIRD**—The Back Rest rests on two teeth, and can be instantly changed for use on either a Band or Circular Saw, or the Shaper can be tilted at different angles to suit the pitch of the teeth.

**FOURTH**—The Tooth Gauge Holder may be moved up or down to change the wearing face on its jaws without changing the gauge of the finished point. This is a valuable feature.

**FIFTH**—You will notice the Tooth Gauge can be used on both ends. Where it is convenient it will be best to specify the range of Saws by gauge so that the ends of the Tooth Gauge may be fitted to different gauge Saws.

The New Shaper is handsomely finished, nickel-plated, buffed and of the highest grade steel and best workmanship, fully up to the previous standard.

### List Prices.

No. 5	For Saws from 10 to 16 gauge.....	Each, \$37 50
No. 6	For Saws from 17 to 24 gauge and thinner.....	" 37 50

For Net List of Parts see page 219.



## PARTS FOR PRIBNOW SHAPERS.

### Nos. 1, 2 and 3.

Stock Letter.	DESCRIPTION.	Price Each, Net.
A	Base Block for Shapers No. 1 and No. 3 (including P) .....	\$10 00
A	Base Block for No. 2 (including B and P) .....	11 00
BB	Swivel Bolts (including Nuts and Washers) .....	75
C	Tooth Gauge Bolt (including Washer) .....	15
DD	Swivels or Jaw Holders (including Set Screws) .....	1 25
EE	Jaws or Dies, per pair .....	2 00
FF	Set Screws for EE .....	10
G	Tooth Gauge (including Screw) .....	1 50
H	Clamping Screw .....	1 25
I	Adjusting Screw for EE .....	20
J	Handle (including Screw for Shapers No. 1 and No. 3) .....	1 00
K	Grinding Gauge (including L and M) .....	1 50
L	Clamp for K .....	20
M	Screw for K .....	10
N	Side Handle (wood part only) .....	20
O	Screw for N .....	15
P	Back Guide .....	35

### No. 4.

Stock No.	DESCRIPTION.	Price Each, Net.	Stock No.	DESCRIPTION.	Price Each, Net.
1	Base Block .....	\$12 00	15	Back Rest .....	\$0 50
2	Clamping Lever, complete .....	1 25	16	Grinding Gauge, complete .....	1 25
3	Clamping Screw .....	75	17	Set Screw for No. 16 .....	10
4	Tooth Gauge .....	50	18	Adjusting Screw for No. 15 .....	15
5	Tooth Gauge Holder, complete .....	2 00	19	Stationary Handle, complete .....	35
6	Tooth Gauge Adjusting Screw .....	25	20	Screw for No. 19 .....	15
7	Tooth Gauge Holder Screw .....	15	21	Set Screw for No. 2 .....	10
8	Tooth Gauge Clamping Screw .....	15	22	Guide for No. 10 .....	50
9-10	Clamping and Shaping Jaws .....	75	23	Screw for No. 22 .....	15
11	Guide Screw for No. 9 .....	40	24	Washers .....	10
12	Adjusting Screw for No. 10 .....	15	25	Wood Handle for No. 2 .....	20
13	Bolt for No. 15 .....	15	26	Ferrule for No. 2 .....	10
14	Set Screw for No. 10 .....	10	27	Adjusting Screw for No. 16 .....	10

### Nos. 5 and 6.

Stock No.	DESCRIPTION.	Price Each, Net.	Stock No.	DESCRIPTION.	Price Each, Net.
1	Base Block .....	\$12 00	15	Back Rest .....	\$0 50
2	Clamping Lever, complete .....	1 25	16	Grinding Gauge, complete .....	1 25
3	Clamping Screw .....	75	17	Set Screw for No. 16 .....	10
4	Tooth Gauge .....	75	18	Screw for holding No. 15 .....	15
5	Tooth Gauge Holder, complete .....	2 00	19	Stationary Handle, complete .....	35
6	Tooth Gauge Adjusting Screw .....	15	20	Screw for No. 19 .....	15
7	Tooth Gauge Holder Screw .....	15	21	Jam Nut for No. 3 .....	15
8	Tooth Gauge Clamping Screw .....	25	22	Bracket for No. 15 .....	75
9-10	Clamping and Shaping Jaws .....	75	23	Wood Handle for No. 2 .....	20
11	Guide Screw for No. 9 .....	40	24	Steel Ferrules for No. 2 and No. 3 .....	10
12	Adjusting Screw for No. 10 .....	15	25	Washers .....	10
13	Screws for holding No. 22 .....	15	25	Adjusting Screw for No. 15 .....	10
14	Adjusting Screw for No. 10 .....	10			

N. B.—In ordering Parts, be sure and specify the Number of the Shaper and also the Stock Letter or Stock Number of the Part required. Above prices include postage when sent by mail.



## NEW IMPROVED PRIBNOW SWAGE SHAPER.

1909 Model.

The Jaw carriers are mounted in a positive chuck movement and are operated toward and from each other by a right and left hand screw, operated by one lever. The Jaws are independently adjusted on the carrier, thus enabling the operator to finish the points of the teeth on both sides with great precision. The Tooth Gauge Holder straddles the Saw and

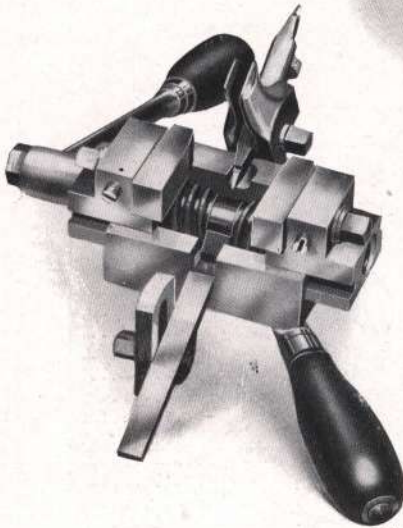

keeps the tooth gauge exactly in line over the tooth being operated upon. A new wearing place on the jaws can be secured without changing gauge of finished point by simply adjusting tooth gauge holder up or down. The tooth gauge holder rests on two teeth, making a positive guide for tooth to enter stop notch. The shaper can be so tilted that the tooth gauge exactly fits point of tooth and the bevel on the shaping jaws comes in contact with swaged points in such a way (both jaws moving up alike) that tooth is pressed into perfect shape as in a mould. It is exactly even from both sides and is given at the same time that form which affords the most perfect clearance and economy of power and lumber.

The tooth gauge has a double end and can be fitted to suit a large range of Saws in gauge. It opens up like a book, see illustration to the left. Every screw and adjustment is in plain sight of the operator.

### List Prices.

No. 7	For Band or Cir. Saws from 5 to 13 ga., complete with wrench and grinding ga.	\$45 00
No. 8	For Band or Cir. Saws from 13 to 18 ga., complete with wrench and grinding ga.	45 00

### Parts for Nos. 7 and 8 Shapers.

Stock No.	NAME OF PART.	Price Each, Net.	Stock No.	NAME OF PART.	Price Each, Net.
1	Base Block.....	\$12 00	18-19	Screw for Holding No. 6 and No. 8.....	\$0 15
2	Jaw Holder, Left Hand.....	2 00	20	Screw for Holding No. 11.....	15
3	Jaw Holder, Right Hand.....	2 00	21	Screw for Holding No. 12.....	15
4	Clamping Screw.....	1 50	22	Adjusting Screw for No. 13.....	15
5	Tooth Gauge Holder.....	2 00	23-24	Adjusting Screws for No. 5 and No. 8.....	10
6	Back Rest Bracket.....	1 00	25	Adjusting Screw for No. 7.....	10
7	Clamping Jaws.....	75	26	Washers for No. 15 and No. 16.....	10
8	Tooth Gauge.....	1 00	27	Washer for No. 17.....	10
9	Back Rest.....	75	28	Wood Handles with Ferrules.....	30
10	Clamping Lever.....	2 25	29	Ferrules for No. 26.....	10
11	Guide Handle.....	35	30	Grinding Gauge.....	1 50
12	Centering Block.....	25	31	Set Screw for No. 30.....	10
13	Take-Up Wedge.....	1 00	32	Adjusting Screw for No. 30.....	10
14	Jam Nut for No. 4.....	15	33	Washers for No. 28.....	10
15	Screw for No. 5.....	20	34	Guide Screw for No. 5.....	15
16	Screw for No. 9.....	15	35	Locknut for No. 34.....	15
17	Screw for Holding Jaws (No. 7).....	15		Nos. 34 and 35 are for No. 7 Shaper only.	

N. B.—In ordering Parts, be sure and specify the Number of the Shaper and also the Stock Number of the Part required. Above prices include postage when sent by mail.

**ATKINS GUMMERS.**

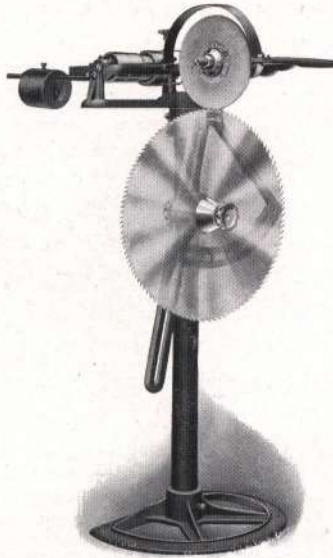

**ATKINS  
PERFECTION  
GUMMER.**

Price ..... \$40 00

Including Mandrel, Belt and  
12 x ½-in. Emery Wheel.



**ROMER'S  
PUNCH  
GUMMER No. 2**

For Cross-Cut Saws.  
(20 pounds.)

Price ..... \$12 00  
Extra Punches, net.. 1 50  
Extra Dies, net .... 1 50

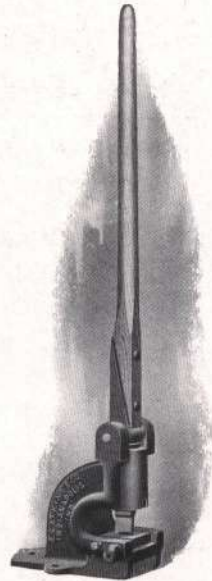

**ATKINS  
PUNCH  
GUMMER.**

For Band and Cross-Cut  
Saws.

Price ..... \$27 00  
Extra Punches and  
Die, per set ..... 7 00

We furnish Dies for shearing  
Band Saws to be used in  
Atkins Gummer.

Price, per pair.....\$8 00



## ATKINS CYLINDER SAW GUMMER.

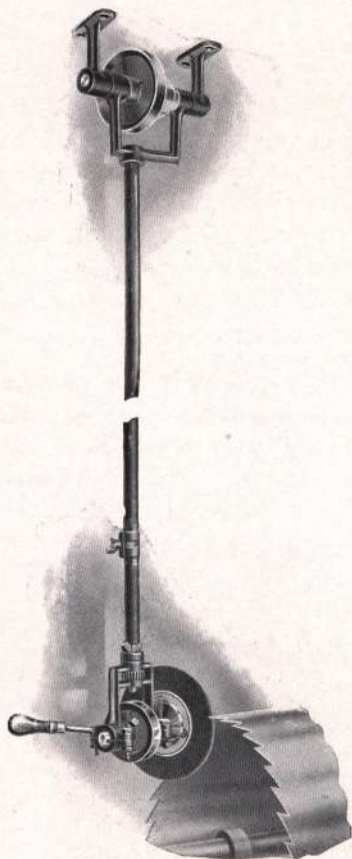

**Can be Used for Gumming any  
Kind of a Saw.**

This illustration shows the Atkins Cylinder Saw Gummer. This Gummer is adjustable, being so constructed that it can be raised or lowered, and the wheel can be used at any desired angle while the Gummer is in use.

Price, \$20.00.

Including Belt and Emery Wheel.

## ATKINS SHINGLE SAW SET GAUGE.

**For Cylinder, Shingle and  
Heading Saws.**

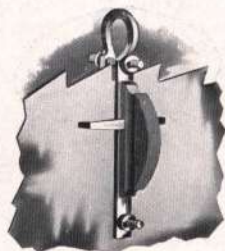

Nickel Plated, each, 75 cents.

## COUNTER SHAFT.

Arbor 24-inch long by  $1\frac{3}{16}$ -inch diameter.

Tight and loose pulleys  $4\frac{1}{2}$ -inch diameter by 3-inch face for 3-inch belt.

One two step cone pulley  $8\frac{1}{2}$  by  $7\frac{1}{2}$  with two faces for 2-inch belt.

List Price, \$10.00.

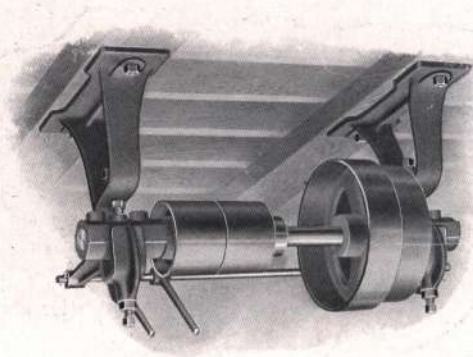



## THE "STANDARD" SAW GUMMER.

**WARRANTED.**

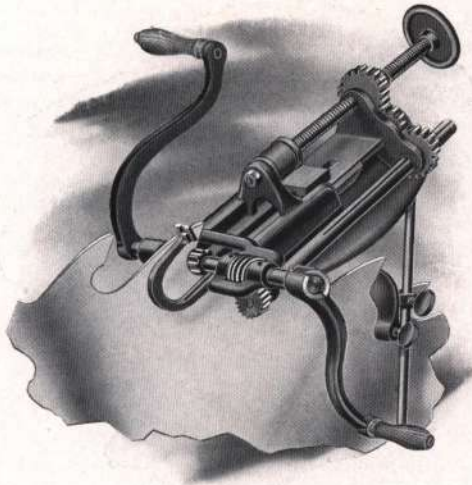

Has an automatic changeable self-feed, is very simple in construction, and beyond question a very complete and superior machine.

The "Standard" Saw Gummer complete, with three arbors, two cranks and wrench, with four solid cutters, any size on list, and one cutter grinder.

List, \$20.00.

The "Standard" Saw Gummer complete, with three arbors, two cranks and wrench, with two inserted tooth cutters, any size on list, and fifty teeth.

List, \$20.00.

## THE "I X L" SAW GUMMER.

**WARRANTED.**

Has a changeable self-feed, but is not automatic. It is pronounced first-class by those using it, and we sell it as such. It is designed especially as a low-priced Gummer; is strong and will do its work thoroughly.

The "I X L" Saw Gummer complete, with three arbors, two cranks and wrench, with three solid cutters, any size on list, and one cutter grinder.

List, \$15.00.

The "I X L" Saw Gummer complete, with three arbors, two cranks and wrench, with one inserted tooth cutter, any size on list, and fifty teeth.

List, \$15.00.

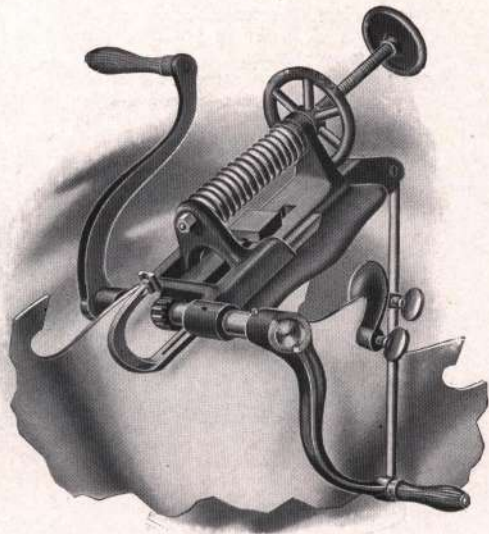

## MIXTER PATENT, CHAMPION GUMMER. WITH AUTOMATIC SELF-FEED.

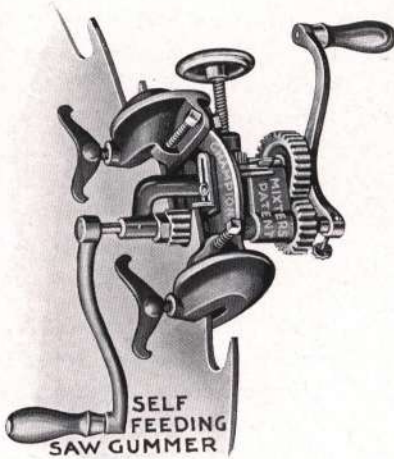

**No. 1. Large Size.**

The engraving represents Mixer's Famous Champion Gummer, with patent adjustable Automatic Self-Feed. It can be regulated at will to feed faster or slower, according to the work to be performed, and can be changed in an instant from self-feeding to hand-feeding.

It is self-acting, throwing itself out of gear when the teeth are cut to the required depth, making them of uniform length.

The Champion has the lateral or oscillating movement of the cutter, and is fully adjustable to all kinds of saws, from the largest circular to the smallest in general use; also mill and cross-cut saws. The line of the teeth can be cut at any angle desired from horizontal to perpendicular. It cuts very rapidly, and with no risk of bending, breaking or case hardening the saw.

### Price List Mixer's Patent Champion Gummers.

No. 1. Patent Automatic Self-Feeding Gummer, including three cutters (usual size,  $\frac{3}{8}$ ,  $\frac{1}{2}$  and 1-in.) grinder and wrench. \$25 00  
Extra arbors for  $\frac{3}{8}$ ,  $\frac{1}{2}$  and  $\frac{3}{8}$ -inch cutter for No. 1 Champion Gummers, net... 2 00

## MIXTER PATENT, CHAMPION GUMMER. WITH AUTOMATIC SELF-FEED.

The engraving represents the Patent Self-Feed Champion Gummer in position to gum mill saws or cross-cut saws.

Especially adapted to cross-cut saws, and small and medium circular saws, etc. Shingle mills, planing mills, sash, door and blind factories, wagon and carriage, pattern and furniture shops, all need this gummer. It is also especially handy for lumbermen to carry in the woods for gumming cross-cut saws. It will soon pay its cost in saving of time and files.

The small size Champion has all the improvements and advantages of the large size Champion Automatic Self-Feed Gummer. Full directions sent with each Gummer.

No. 2 Mixer Patent Automatic Self-Feeding Champion Gummer, including three cutters  $\frac{3}{8}$ ,  $\frac{1}{2}$  and  $\frac{3}{8}$ -inch grinder and wrench.

Weight, boxed, 22 pounds.

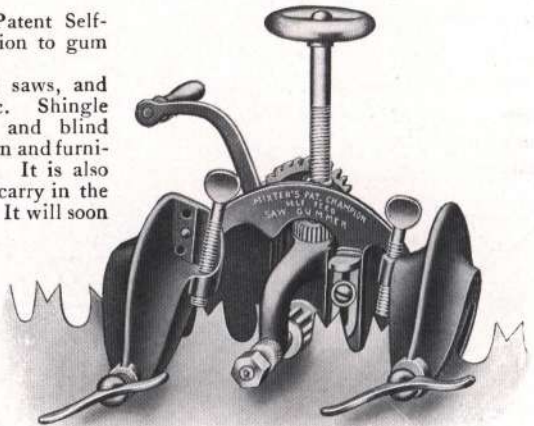

**No. 2. Small Size.**

List Price, Mixer Patent, Champion Gummer, No. 2 .....\$25 00  
Extra arbor for  $\frac{3}{8}$ -inch cutter for No. 2 Champion Gummers, Net..... 1 50



**GUMMER CUTTERS.**

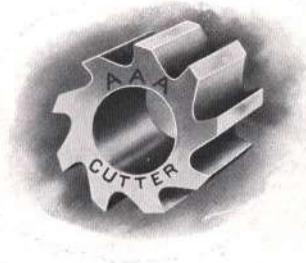

**Prices of Gummer Cutters.**

For Mixer's, Standard, I. X. L., Boss, Disston's XX and AAA Gummers. When ordering give make of Gummer.

Size, inches.....	$\frac{3}{8}$	$\frac{1}{2}$	$\frac{5}{8}$	$\frac{3}{4}$	$\frac{7}{8}$	1	$1\frac{1}{8}$	$1\frac{1}{4}$	$1\frac{1}{2}$	$1\frac{3}{4}$
Each .....	\$0 50	0 50	0 50	0 60	0 70	0 80	0 90	1 00	1 25	1 75

**STONE'S GUMMER CUTTERS.**

Size, inches.....	$\frac{3}{8}$	$\frac{1}{2}$	$\frac{5}{8}$	$\frac{3}{4}$	$\frac{7}{8}$	1
Each .....	\$0 50	0 50	0 75	1 00	1 25	1 50

**STAR GUMMER CUTTERS.**

Size, inches.....	$\frac{3}{4}$	$\frac{7}{8}$	1
Each .....	\$0 55	0 60	0 65

NOTE.—In ordering cutters, be sure and give size of hole, as well as size of cutter required, or you can send us an impression of one end of cutter on paper. Be particular to state what Gummer they are to be used in.

**IMPROVED CUTTER GRINDER.**

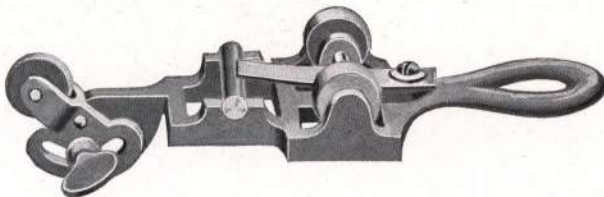

Price, \$1.00.

Grinds cutters perfectly round and true. We give a Grinder free with each Gummer.



## ATKINS EMERY WHEEL SAW GUMMERS.

### AA GUMMERS.



#### SPECIFICATIONS.

Diameter of pulley, 3 inches.  
 Face of pulley,  $2\frac{3}{8}$  inches.  
 Will carry wheel 10 inches in diameter,  $1\frac{1}{4}$ -inch face.

Price, each, \$8.00.

Emery Wheels extra.

### AAA GUMMERS.

Same pattern as AA, illustrated above. Larger and for heavier work.  
 Pulley diameter,  $3\frac{1}{4}$  inches; face,  $2\frac{1}{2}$  inches; carry wheel,  $14 \times 1\frac{1}{2}$  inches.  
 Price, AAA Gummers, each, \$12.00.

Emery Wheels extra.

## ATKINS DOUBLE END GRINDER.

Will carry two Wheels  $12 \times 1\frac{1}{2}$  inches or smaller. Equipped with tight and loose pulleys, two adjustable rests, babbitted bearings, and brass oil cups. (Note the four cap screws to each bearing.)

#### Specifications.

Weight, 65 pounds.  
 Height from base to center of arbor,  $8\frac{1}{2}$  in.  
 Distance between wheels,  $14\frac{3}{4}$  inches.  
 Length of bearings, 4 inches.  
 Length of arbor, 21 inches.  
 Diameter of arbor in bearings,  $1\frac{1}{8}$ -inch.  
 Diameter of arbor between collars, 1-inch.  
 Size of pulleys,  $3 \times 2\frac{1}{2}$  inches.



The above cut shows Grinder equipped with a  $12 \times 1\frac{1}{2}$ -inch square faced wheel for tool grinding on one end, and a  $12 \times \frac{3}{8}$ -inch wheel for saw gumming on the other end.

Price, each, \$12.50.

Emery Wheels extra.

## ATKINS GRINDERS—Continued.

Atkins Grinders are decidedly the best value. They are well built from the best materials. They are completely equipped with adjustable boxes, babbitted bearings, brass oil cups, suitable rests and pulleys.

### ATKINS No. 1 GRINDER.

For Jewelers, Dentists, Repair Shops, or any light grinding. Will carry two wheels 6x1-inch or smaller. A Taper Spindle can be instantly attached for Buffing and Polishing work. Adjustable babbitted bearings, nickel-plated spring cap oil cups.



**No. 1.**

Weight.....	10½ pounds
Height from Base to Center of Arbor.....	5½ inches
Distance between Wheels.....	6 inches
Length of Bearings.....	1⅞ inches
Length of Arbor.....	9½ inches
Diameter of Arbor in Bearings.....	⅞-inch
Diameter of Arbor between Flanges.....	½-inch
Size of Pulley.....	1¼x1½ inches

Taper Spindle, 50 cents additional.

For Saw Gumming, and Wood-working Plants. An exceptionally rigid, substantial machine. Will carry a 12x1¼-inch wheel or smaller. Adjustable rest, babbitted bearings, brass oil cups.

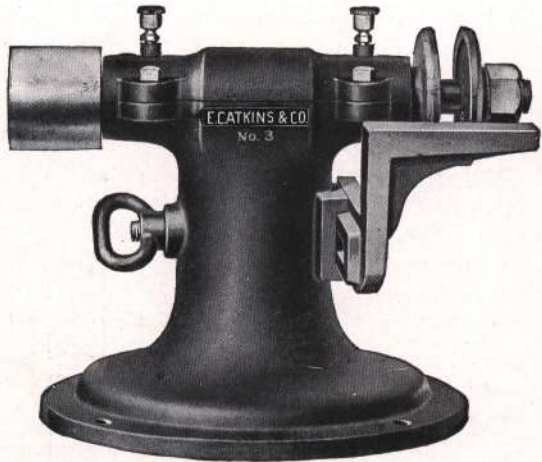

**No. 3.**

Weight.....	44½ pounds
Height from Base to Center of Arbor.....	9 inches
Length of Bearings.....	3 inches
Length of Arbor.....	14¾ inches
Diameter of Arbor in Bearings.....	1½ inches
Diameter of Arbor between Flanges.....	1-inch
Size of Pulley.....	3x2½ inches
Diameter of Base.....	12 inches

#### List Price.

No. 1.....	\$5 00	No. 3.....	\$10 00
------------	--------	------------	---------

ATKINS AAA CORUNDUM WHEELS.

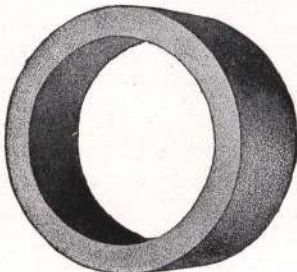
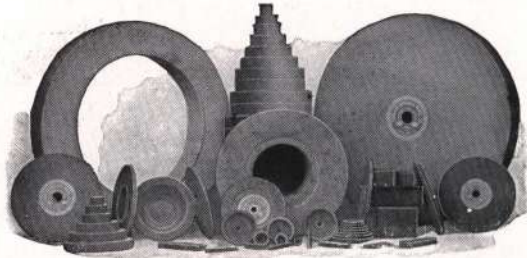

Cylinder.

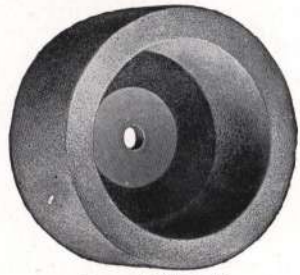

Cup Wheel.

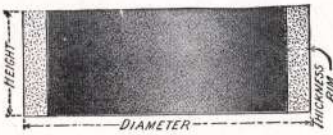

Section.

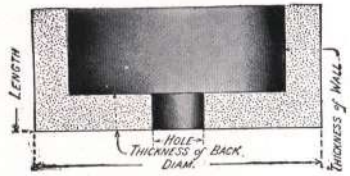

Section.

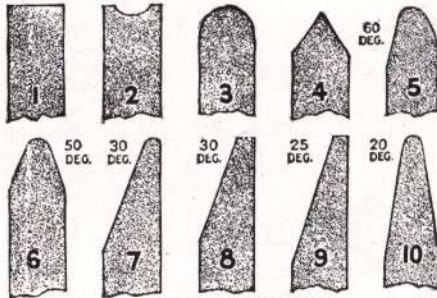

Different Faces.

POINTS ON ORDERING WHEELS.

Always give us the following information plainly when ordering wheels, as this will enable us to intelligently fill your order and send that particular wheel and grade which will best meet your requirements.

1—Quantity required. 2—Diameter of Wheels. 3—Thickness of Wheels. 4—Size of Arbor Hole. 5—Coarseness, viz: Size of Grain. (See following page.) 6—Hardness, viz: Grade Letter. (See following page.) 7—Description of work Wheel is to perform. 8—Speed Wheel is to run, viz: Number of revolutions per minute of arbor on which Wheel is to run.



## ATKINS AAA CORUNDUM WHEELS.

### OUR GRADE LIST.

D—Extremely soft.	J—Medium soft	P—Medium hard
E	K	Q
F	L	R
G—Soft	Medium	S—Hard
H	N	T
I	O	U
		V—Extremely hard

The above is for the convenience of dealers, agents and those preferring to make their own grade selection. We strongly urge, however, that selection of grain and grade be left to us, when full information regarding the use of the Wheel can be given.

The intermediate letters between those designated as soft, medium soft, etc., indicates so many degrees harder or softer. That is to say L is one grade or degree softer than medium; O, two degrees harder than medium, but not quite medium hard.

### Suggestions for selecting Grain and Grade of Wheel.

Where the selection of the grain and grade is left to us, as recommended above, it is only necessary to give us fullest possible information regarding work to be performed and speed at which Wheel is to run.

When ordering Wheels for difficult or very particular work, send us, if possible, a stub or piece of Wheel that has given best satisfaction.

Kind of Work	No. of Corundum	Grade Letter
Castings, large iron and steel.....	12— 20.....	Q—R
Castings, small iron and steel.....	20— 30.....	O—P
Castings, large malleable iron.....	12— 20.....	Q—R
Castings, small malleable iron.....	20— 30.....	O—P
Castings, chilled iron.....	12— 20.....	Q—R
Castings, brass.....	16— 30.....	O—P
Castings, bronze.....	16— 30.....	P—Q
Wrought iron.....	16— 30.....	P—Q
Rough work.....	16— 30.....	P—Q
General Machine shop work.....	30— 46.....	O—P
Lathe and planer tool.....	30— 46.....	O
Small machine and hand tool.....	36—100.....	O
Woodworking tools.....	46— 60.....	N
Special twist drill grinder.....	46— 60.....	K
Hand grinding twist drills.....	46— 60.....	N
Reamers, taps, milling cutters, etc., hand grinding.....	46—100.....	N—P
Same as above for automatic machines.....	46— 80.....	J—L
Edging and jointing agricultural implements.....	16— 30.....	Q—R
Grinding plow points.....	16— 30.....	P—Q
Plow bodies.....	20— 30.....	N—O
Stove mounting.....	20— 36.....	P—Q
Finishing stove edges.....	24— 36.....	O—Q
Drop forging.....	20— 30.....	P—Q
Saw gumming.....	30— 70.....	L—M
Planing and paper cutting knives.....	30— 36.....	J—K
Car wheels.....	16— 30.....	O—Q



# CORUNDUM AND EMERY WHEELS.

**Standard Price List.**

Always give diameter of wheel, thickness, size of hole, shape of face and for what purpose used.

Diam. in Inches.	THICKNESS OF WHEELS IN INCHES.																Diam. in Inches.	No. of Revol. per Min.	
	1/4	3/8	1/2	5/8	3/4	7/8	1	1 1/4	1 1/2	1 3/4	2	2 1/4	2 1/2	2 3/4	3	3 1/4			3 1/2
1	\$0.25	\$0.30	\$0.30	\$0.35	\$0.40	\$0.40	\$0.45	\$0.50	\$0.55	\$0.60	\$0.65	\$0.70	\$0.75	\$0.80	\$0.85	\$0.90	\$1.00	1	.....
1 1/2	30	35	40	45	50	50	55	60	65	70	75	80	85	90	95	1.00	1.10	1 1/2	.....
2	35	45	50	55	60	60	65	70	75	80	85	90	95	1.00	1.05	1.10	1.20	2	.....
2 1/2	40	50	55	60	65	65	70	75	80	85	90	95	1.00	1.15	1.25	1.35	1.45	2 1/2	.....
3	50	60	65	70	75	80	85	90	95	1.00	1.15	1.25	1.40	1.55	1.70	1.85	2.00	3	7400
3 1/2	60	70	75	80	85	90	95	1.05	1.15	1.25	1.35	1.45	1.55	1.65	1.75	1.85	2.00	3 1/2	.....
4	75	80	85	90	95	1.05	1.15	1.25	1.35	1.45	1.55	1.65	1.75	1.85	1.95	2.05	2.20	4	.....
4 1/2	1.10	1.25	1.40	1.55	1.70	1.85	2.00	2.15	2.30	2.45	2.60	2.75	2.90	3.05	3.20	3.35	3.50	4 1/2	5500
5	1.00	1.20	1.40	1.60	1.80	2.00	2.20	2.40	2.60	2.80	3.00	3.20	3.40	3.60	3.80	4.00	4.20	5	4400
6	1.40	1.60	1.75	2.10	2.40	2.75	3.05	3.40	3.80	4.20	4.55	4.90	5.25	5.60	5.95	6.30	6.65	6	3600
7	1.85	2.00	2.15	2.60	3.00	3.45	3.85	4.30	4.75	5.20	5.65	6.10	6.55	7.00	7.45	7.90	8.35	7	2450
8	2.10	2.30	2.60	3.10	3.60	4.10	4.60	5.10	5.60	6.10	6.60	7.10	7.60	8.10	8.60	9.10	9.60	8	2100
9	2.50	2.80	3.10	3.70	4.40	5.10	5.80	6.50	7.20	7.90	8.60	9.30	10.00	10.70	11.40	12.10	12.80	9	1800
10	3.00	3.30	3.65	4.35	5.00	5.70	6.35	7.00	7.65	8.30	8.95	9.60	10.25	10.90	11.55	12.20	12.85	10	1650
12	3.60	3.80	4.00	5.00	6.00	6.00	7.00	7.40	7.90	8.40	8.90	9.40	9.90	10.40	10.90	11.40	11.90	12	1400
14	4.05	5.15	6.25	7.35	8.45	9.55	10.65	11.75	12.85	13.95	15.05	16.15	17.25	18.35	19.45	20.55	21.65	14	1200
16	.....	.....	.....	.....	.....	.....	.....	.....	.....	.....	.....	.....	.....	.....	.....	.....	.....	16	.....
18	.....	.....	.....	.....	.....	.....	.....	.....	.....	.....	.....	.....	.....	.....	.....	.....	.....	18	.....
20	.....	.....	.....	.....	.....	.....	.....	.....	.....	.....	.....	.....	.....	.....	.....	.....	.....	20	.....
22	.....	.....	.....	.....	.....	.....	.....	.....	.....	.....	.....	.....	.....	.....	.....	.....	.....	22	.....
24	.....	.....	.....	.....	.....	.....	.....	.....	.....	.....	.....	.....	.....	.....	.....	.....	.....	24	.....
26	.....	.....	.....	.....	.....	.....	.....	.....	.....	.....	.....	.....	.....	.....	.....	.....	.....	26	.....
28	.....	.....	.....	.....	.....	.....	.....	.....	.....	.....	.....	.....	.....	.....	.....	.....	.....	28	.....
30	.....	.....	.....	.....	.....	.....	.....	.....	.....	.....	.....	.....	.....	.....	.....	.....	.....	30	.....
32	.....	.....	.....	.....	.....	.....	.....	.....	.....	.....	.....	.....	.....	.....	.....	.....	.....	32	.....
34	.....	.....	.....	.....	.....	.....	.....	.....	.....	.....	.....	.....	.....	.....	.....	.....	.....	34	.....
36	.....	.....	.....	.....	.....	.....	.....	.....	.....	.....	.....	.....	.....	.....	.....	.....	.....	36	.....

# CORUNDUM AND EMERY CYLINDERS AND CUP WHEELS.

The following list is figured on a basis of Cylinders 7 inches long, other lengths at proportionate rates. To obtain price of Cup Wheels, add the price of a regular wheel, whose diameter is the inside diameter of the cylinder, and thickness whatever is required.

Diam. in Inches.	THICKNESS OF RIM.						Diam. in Inches.	THICKNESS OF R.I.M.					
	1	1 1/2	2	2 1/2	3	3 1/2		1	1 1/2	2	2 1/2	3	3 1/2
8	\$15.50	\$22.00	\$29.50	\$38.75	\$44.00	\$57.50	18	\$28.80	\$40.25	\$51.40	\$61.40	\$71.00	\$86.90
9	17.25	24.25	33.00	45.50	51.50	67.60	20	30.90	44.00	56.25	67.40	78.50	97.00
10	18.75	26.25	36.00	48.50	55.00	73.00	22	35.00	49.75	62.50	74.00	86.25	115.50
12	22.50	31.00	38.50	51.50	58.00	78.00	24	37.50	54.25	70.50	84.00	100.00	126.60
14	26.00	35.75	44.60	53.00	60.25	83.00	26	39.75	59.80	77.00	93.00	113.60	159.25



## HUNTINGTON EMERY WHEEL DRESSER.



For turning, shaping, sharpening and removing glaze from solid emery wheels, running at full speed.

Price, Huntington Emery Wheel Dresser, each, 75 cents.



Cutters, per set, 15 cents.

## THE "KEYSTONE" CONNECTING LINK. Patented.

The Keystone Link is Drop Forged from Bar Steel and Forms the Strongest Link in the Chain. Imitations are made of Malleable Iron Castings and are Comparatively Worthless.



The Keystone Connecting Link for connecting new or repairing broken chains of any kind—is composed of two corresponding halves centrally pivoted on the same axis. As shown by the illustration herewith, the inner flat face of each member is pivoted with a projecting lug and recess, so that when closed and in use they mutually interlock, and by abutting against each other, lateral displacement of the two halves, and their consequent spreading or parting—is rendered impossible. The Keystone Link is drop forged from an especially tough grade of bar steel, is the only one so made, and must not be confused with similar devices which are simply malleable iron castings.

As everyone knows, "a chain is only as strong as its weakest link." You would not buy a malleable or cast iron chain—why then repair a wrought chain with a cast link, thereby definitely fixing its point of failure?

THEIR STRENGTH—They have been proven by numerous tests to be as strong as a solid welded chain link of corresponding size, and being made of steel in place of iron, they are in point of fact the strongest link of the chain in which they are used.

### Price List.

Size, inches.....	$\frac{1}{4}$	$\frac{5}{16}$	$\frac{3}{8}$	$\frac{7}{8}$	$\frac{1}{2}$	$\frac{5}{8}$	$\frac{3}{4}$	1
Per dozen.....	\$2 00	2 25	2 50	3 25	4 00	7 50	10 00	15 00

Sizes up to one-half inch packed one dozen in a box, or shipped in bulk if desired.



## ATKINS PATENT SIDE FILES.



**Adjustable No. 1.**

The No. 1 File is the simplest tool ever invented for the purpose. The width of the set or swaged tooth is regulated by a single set screw. The clamp for holding the file is adjustable, permitting the use of any kind of file, if one of our files made especially for them can not be easily obtained. This tool is especially adapted for Circular Saws.

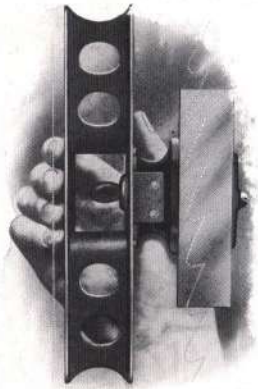

**Adjustable No. 2.**

The No. 2 File is adjustable for holding any kind of file, similar to the No. 1, and by its shape is peculiarly adapted for long saws, such as Band and Gang Saws. It can be used on blades down to two inches in width, and as wide as desired. No one who runs such saws should be without this tool. It is also preferred by some on Circular Saws.

### Price

No. 1, for Circular Saws.....	Each, \$1 00
No. 2, for Band, Gang and Circular Saws .....	" 1 00
No. 3, for Band Saws.....	" 1 00
Extra Files for Nos. 1 and 2.....	Per dozen, 1 50
Extra Files for No. 3.....	" 2 00

Side Files are used for the purpose of regulating saw teeth after they have been set. It is impossible to set or upset a saw so that some of the teeth will not extend or be bent over a little more than others, and thus make rough lumber. By the use of these instruments all the teeth are made even; and a saw thus regulated will run twice as long without sharpening, and do much better work.

The reputation of our Adjustable Side Files is fully established, being acknowledged as most convenient and accurate tools. No. 2 is entirely novel in its construction and adaptability. It is easily operated, and insures accurate work.

## ATKINS PATENT SIDE FILE No. 3.

### FOR BAND AND GANG SAWS.

The No. 3 File is adjustable for holding 8-inch and 9-inch files, and so arranged that the file can be tilted to any desired angle. A gauge passes over the points of the teeth, bringing the file in proper position for doing the work. The No. 3 File is for all long saws. It can be used on any width of blade.

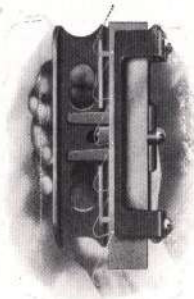

**Adjustable No. 3.**

**ATKINS BRAZING TABLES.**

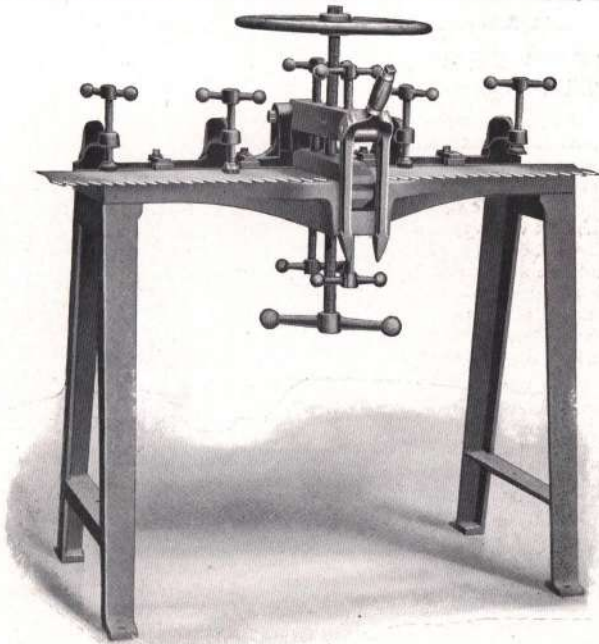

**This Cut Represents Our No. 3 Table.**

These Brazing Tables have been designed from practical experience in our own factory and have proved to be most effective and satisfactory.

No. 1	Without legs, for brazing Band Saws up to 12 inches wide.....	\$37 50
No. 2	Without legs, is much heavier than our No. 1 and is suitable for brazing Band Saws up to 14 inches wide.....	45 00
No. 2x	Without legs, for Bands to 16 inches wide.....	56 25
No. 3	With legs, otherwise same as No. 2.....	56 75
No. 3x	With legs, otherwise same as No. 2x.....	67 50

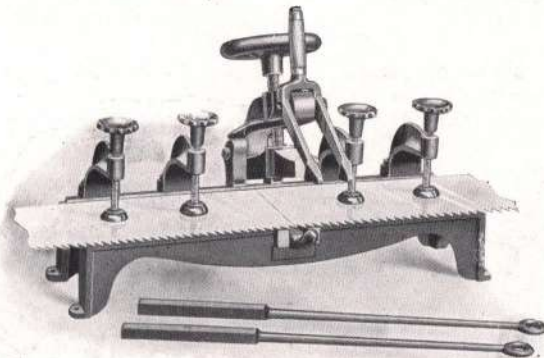

**List Prices.**

No. 4	For Band Saws 9-inches in width and less.....	\$25 00
No. 5	For Band Saws 6-inches in width and less.....	18 75

**ATKINS BRAZING AND FILING CLAMPS FOR BRAZING NARROW BAND SAWS.**

**DIRECTIONS FOR BRAZING.**

Bevel the ends of saw about one-half inch, and bind firmly together with two or three strands of very fine wire. Fasten the saw in position with the set screws in clamp; place a small piece of silver solder on the lap, and cover with powdered borax. The braze can then be made either with our alcohol lamp with automatic blower, or with the common brazing tongs. Use the half circle of clamp when filing the bevel and in finishing up braze.

Price each, \$3.75.

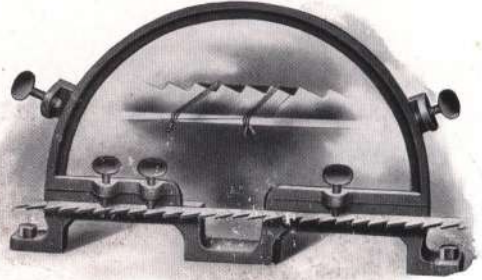

**DIRECTIONS FOR USING LAMP.**

Use alcohol in both lamps and in the blower, having the blower about half full. Light both wicks in the lamps and place the heating lamp in position under the blower. See that the blow pipe is directed against the base of the blaze, and in a moment, as the alcohol becomes heated, the flame can be sent in any direction, and the weld quickly made. As the solder melts, spread it evenly over the surface of the saw with the point of a file.

Price each, \$4.50.

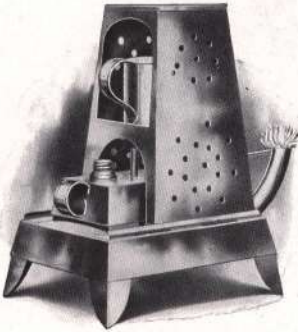

**BRAZING TONGS AND CLAMPS FOR BAND SAWS.**



To braze from 2 to 6-inch, with clamp..... Each, \$7 50  
 For bands 1½-inch and under, no clamp..... " 3 00

**SILVER SOLDER.**

The successful brazing of Band Saws largely depends on the solder used. We use, and keep constantly in stock, special Silver Solder that has proved to be the best adapted for brazing tempered steel.

We will furnish Silver Solder at the lowest market price, predicated on the price of silver.

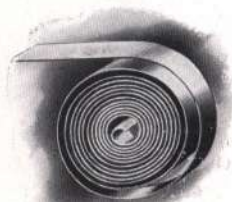



## ATKINS PATENT COMBINED CIRCULAR SAW GUIDE AND ROUNDER.

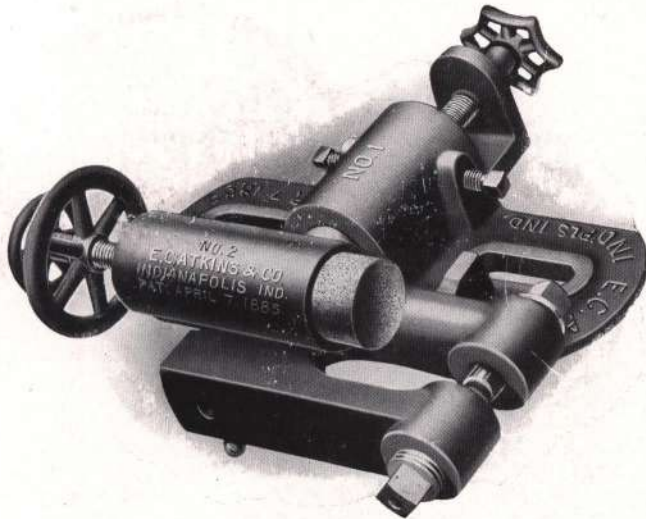

### THE GUIDE.

This invention, used simply as a Saw Guide, has advantages which are possessed by no other guide. A glance at the accompanying engraving will make this fact apparent to every practical saw-mill man. Guide is adjustable and reversible. If the guide-pins *E* are set at a proper distance apart to admit the rotation of the saw, the adjustment is easily accomplished without danger to the operator while the saw is in motion. Loosen the set-screw *D* and turn the hand-wheel *A* in the direction required until the saw has the proper lead. Every sawyer will appreciate the practical value of this feature of our Guide, as the adjustment of Saw Guides—often necessary or desirable to change the lead of the saw—has heretofore been attended with more or less danger, or accomplished with considerable inconvenience and loss of time by the stoppage of the mill. Being reversible, our Guide may be used on a right or left-handed mill, or turned back to permit the removal of the saw from the arbor without displacing the Guide. Loosen the set-screw *D* and turn back the arms of the Guide, or reverse them as is desired. In the sleeve enclosing the shank of the Guide is inserted the set-screw *D*, which fits into a groove on either side of the shank, and which is employed to hold the arms of the Guide rigid when turned either to right or left, preventing them from turning over whenever the motion of the saw is reversed. When the Guide is in use the set-screw *D* should be set tight.

### THE ROUNDER.

The "ROUNDER" or "JOINTER" is entirely new and original, and its attachment to a Saw Guide a novel and valuable feature. When not in use detach the Rounder by using the thumb nut *F*. Saw teeth frequently require jointing, and no device has ever been constructed that will "round up" a circular saw so perfectly, effectually and conveniently as that we have now introduced in combination with our Saw Guide. Whenever it is desirable to joint the teeth of a saw, the emery block is brought into contact with the rapidly revolving saw by means of the hand wheel *C*, to which the emery block is attached. During the operation the attendant will turn the hand wheel *B*, thereby rotating the emery block so as to present a constantly changing surface for action on the saw teeth, and wear the face evenly. The saw is thus made perfectly round and all ready for dressing, and every tooth will do its proper duty. The saw will wear longer, cut more lumber and the lumber will be smoother.

### Prices.

No. 1, FOR ORDINARY MILLS.	No. 2, FOR HEAVY WORK.
Guide, without Rounder.....\$7 50	Guide, without Rounder.....\$10 00
Combined Guide and Rounder ..... 10 00	Combined Guide and Rounder ..... 12 50

ATKINS SWING SAWS.



No. 7.

We offer exceptional values in this line and particularly recommend our No. 7. The frame hangs on hangers, doing away with imperfect alignment and insuring the utmost rigidity. Cored hollow, giving maximum of strength with least weight..

The head is detachable, permitting of great ease in adjusting, and may be removed or re-babbitted. The Saw Arbor is of best spindled steel and runs in extra long babbitted and self-oiling boxes. Countershaft and hangers of  $1\frac{7}{8}$  steel shafting, have an up and down adjustment, equipped with belt shifter.

Through the use of adjustable counter weight, Saw may be made to hang at any angle. The Saw Guard will accommodate Saw up to 20 inches, or to 24 inches when so specified, at extra cost. Length of frame six feet, tight and loose pulley 8 x 5 inches, drive pulley 16 x 5 inches, arbor pulley 5 x 5½ inches, size of arbor in bearing  $1\frac{7}{8}$  inches, size of arbor where saw goes on  $1\frac{1}{8}$  inches. Speed of countershaft 450 revolutions per minute, weight of saw 400 pounds.

No. 7. List price with Saw.....\$50 00

No. 3. This Saw is similar to No. 7, excepting that the shaft is cast in one piece and is not detachable. List, complete with Saw..... 50 00

**WRIGHT'S  
NON-FRICTION BAND-SAW GUIDE.**

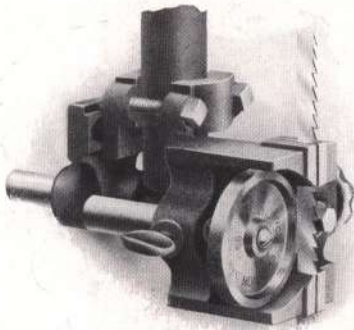

Price, \$10.00.

**WRIGHT'S BAND SAW SETTER.**

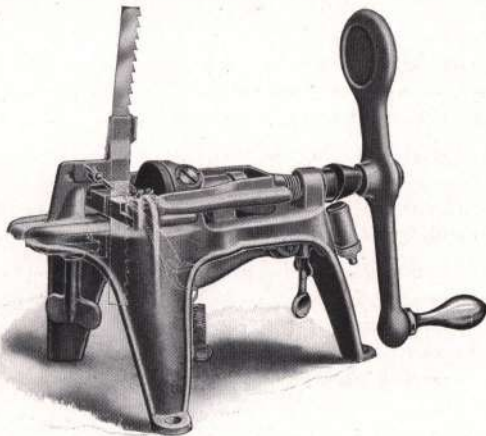

Accommodates Saws from  $\frac{1}{8}$  to 2 inches wide.

Price, \$20.00.



## EQUAL-BLOW SETTING MACHINE. FOR BAND SAW BLADES.

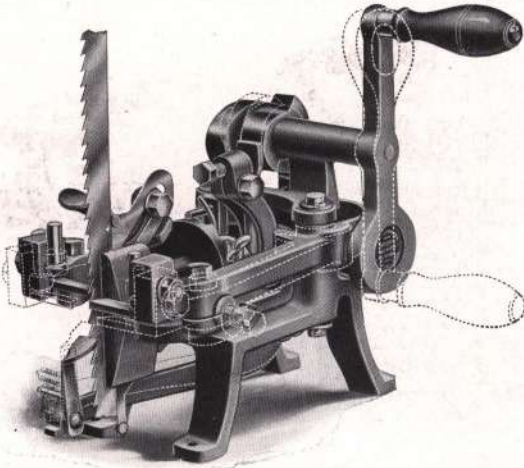

Sets an ordinary Saw in from three to five minutes.

Blades set without removing from machine, or at the bench as desired.

The first and only setting machine in which two teeth are set, one in either direction by two hammers which are pressed by same spring and striking with equal force at the same instant.

Price, \$20.00.

## ATKINS "AAA" CIRCULAR SAW SET.

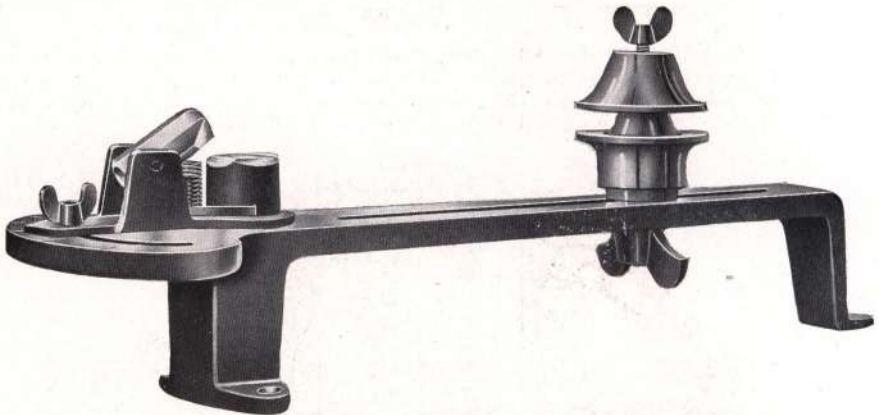

The Atkins "AAA" Circular Saw Set is fastened to the bench or block by three common wood screws. It will accommodate 6 to 24-inch, either Rip or Cut-Off Saws.

The Saw is placed between cone-shaped holder, which is graduated for a hole from **three-fourths to one and one-half** inches. By the use of the thumb-screw the Saw is rendered rigid, but may be revolved on a bearing at the bottom of the cone.

The cone moves in slot to the proper point, and is held in position by thumb-screw on bottom.

The anvil has four surfaces of different degrees of bevel, and revolves into four slots, or stops, making it impossible to change the bevel after being adjusted.

The hammer is supported by spiral spring, and may be revolved in circular slide, and held in position by thumb-screw. This enables the user to secure any hook desired to point of tooth for either Rip or Cut-Off Saws. The hammer arrangement insures an equal blow. The Saw being held in uniform position, a variation in set cannot occur. The set of each tooth must of necessity be uniform. It is so simple that anyone may operate it.

List Price. each complete, \$8.00.

**THE HAMLET DIMENSION GAUGE.**

**Quick, Positive, Accurate.**

**Dimensions Lumber from one-eighth to nine inches.**

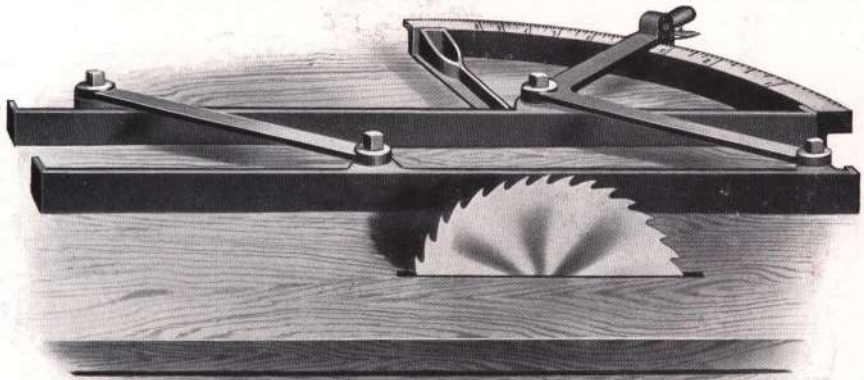

**Cut Represents Right-Hand Gauge.**

Price, \$10.00.

**THE O. K. SAW GUARD.**

**The Best Insurance against Accidents is to prevent them.**

A sure and reliable safeguard against accidents. Removes all danger from using small circular saws. Recommended by Factory Inspectors generally. In use in largest wood-working plants. Its principle is simply and fully demonstrated by this illustration.

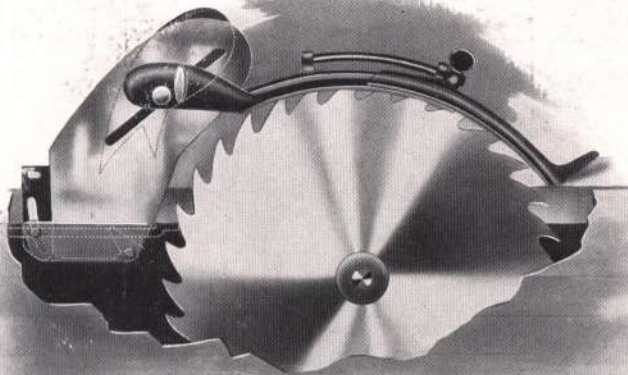

Patented September 12, 1882; July 17, 1883; October 16, 1883; May 27, 1884.

- No. 1 Adjustable to any saw under 16 inches in diameter .....\$6 00
- No. 2 Adjustable to saws between 17 inches and 24 inches..... 7 00

## ATKINS CIRCULAR SAW MANDRELS.

### CAST STEEL. SELF-OILING BOXES.

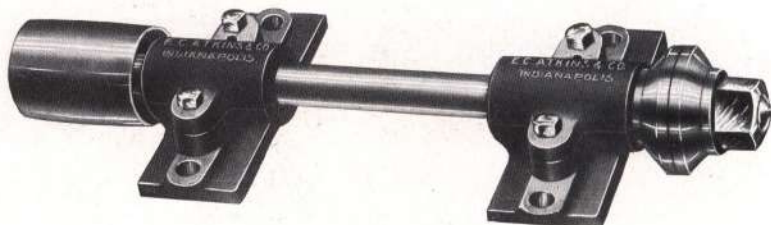

**Pulley Outside Boxes.**

We fill all orders for Mandrels with pulley outside of boxes, unless otherwise ordered. Price does not include saw.

No.	Extreme Length, Inches.	Diameter of Arbor, Inches.	Diameter of Pulley, Inches.	Face of Pulley, Inches.	Diameter of Collars, Inches.	Size of Hole in Saw, Inches.	Size of Saw, Inches.	Price, Each.
1	16½	1 <sup>1</sup> / <sub>16</sub>	3	3	3	1	6 to 12	\$8 00
2	19	1 <sup>1</sup> / <sub>16</sub>	3	3½	3	1	14 to 18	8 50
3	21½	1 <sup>3</sup> / <sub>16</sub>	3	4	3½	1½	20 to 24	9 50
4	24	1 <sup>3</sup> / <sub>16</sub>	3½	4½	3½	1½	26 to 28	10 75
5	26	1 <sup>5</sup> / <sub>16</sub>	4	5	4	1¼	30 to 32	12 50
6	28	1 <sup>5</sup> / <sub>16</sub>	4½	5½	4	1¼	34 to 36	14 00
7	30½	1 <sup>7</sup> / <sub>16</sub>	5	6	4½	1¾	36	16 00
8	33½	1 <sup>7</sup> / <sub>16</sub>	5½	6½	4½	1¾	36	18 00
9	37	1 <sup>9</sup> / <sub>16</sub>	6	7	4½	1½	38	22 50
10	41	1 <sup>11</sup> / <sub>16</sub>	7	8	5	1¾	40	28 00
11	44½	1 <sup>13</sup> / <sub>16</sub>	8	10	5	1¾	40	33 50
12	48	1 <sup>15</sup> / <sub>16</sub>	10	10	5	1¾	42	40 00
13	54	2 <sup>3</sup> / <sub>16</sub>	12	10	5	2	48	50 00

### Larger Sizes Made to Order.

When ordering Saw Mandrels, send sketch and give distance from saw to end of Mandrel if the pulley is between the bearings. If the pulley is on the end of Mandrel, give distance from saw to inside edge of pulley. Also, whether the pulley is on the right or left-hand side of Mandrel when the saw is running toward you.

Our Mandrels are made with pulley on right-hand side, with left-hand thread, unless otherwise ordered.



**ATKINS CIRCULAR SAW MANDRELS.**

**CAST STEEL.  
SELF-OILING BOXES.**



**Pulley Inside Boxes.**

**Price Does Not Include Saws.**

No.	Extreme Length, Inches.	Diameter of Arbor, Inches.	Diameter of Pulley, Inches.	Face of Pulley, Inches.	Diameter of Collars, Inches.	Size of Hole in Saw, Inches.	Size of Saw, Inches.	Price, Each.
1	14	1 $\frac{1}{8}$	3	3	3	1	6 to 12	\$7 50
2	16	1 $\frac{1}{8}$	3	3 $\frac{1}{2}$	3	1	14 to 18	8 00
3	18	1 $\frac{3}{8}$	3	4	3 $\frac{1}{2}$	1 $\frac{1}{8}$	20 to 24	9 00
4	20	1 $\frac{3}{8}$	3 $\frac{1}{2}$	4 $\frac{1}{2}$	3 $\frac{1}{2}$	1 $\frac{1}{8}$	26 to 28	10 00
5	22	1 $\frac{5}{8}$	4	5	4	1 $\frac{1}{4}$	30 to 32	11 50
6	24	1 $\frac{5}{8}$	4 $\frac{1}{2}$	5 $\frac{1}{2}$	4	1 $\frac{1}{4}$	34 to 36	13 00
7	26	1 $\frac{7}{8}$	5	6	4 $\frac{1}{2}$	1 $\frac{3}{8}$	36	14 50
8	28	1 $\frac{7}{8}$	5 $\frac{1}{2}$	6 $\frac{1}{2}$	4 $\frac{1}{2}$	1 $\frac{3}{8}$	36	16 00
9	32	1 $\frac{9}{8}$	6	7	4 $\frac{1}{2}$	1 $\frac{1}{2}$	36	20 00
10	36	1 $\frac{1}{2}$	7	8	5	1 $\frac{5}{8}$	38	26 00

**Larger Sizes Made to Order.**

When ordering Saw Mandrels, send sketch and give distance from saw to end of Mandrel, if pulley is between the bearings. If the pulley is on the end of Mandrel, give distance from saw to inside edge of pulley. Also whether the pulley is on the right or left-hand side of Mandrel when saw is running toward you.

Our Mandrels are made with pulley on right-hand side, with left-hand thread, unless otherwise ordered.

## ATKINS CIRCULAR SAW MANDRELS. CAST STEEL, CONNECTED BOXES AND SELF-OILING.



**Price Does Not Include Saws.**

No.	Extreme Length, Inches.	Length of Frame, Inches.	Distance from Center to Center of Bolt Holes, Inches.	Diameter of Arbor, Inches.	Diameter of Pulley, Inches.	Face of Pulley, Inches.	Diameter of Collars, Inches.	Hole in Saw, Inches.	Size of Saw, Inches.	Price, Each.
1	23½	17	13¾	1 <sup>5</sup> / <sub>16</sub>	3	4	3	7/8	4 to 10	\$9 00
2	26½	19	14½	1 <sup>1</sup> / <sub>8</sub>	3½	4½	3	1	12 to 14	11 00
3	28¾	20½	15¾	1 <sup>3</sup> / <sub>8</sub>	4	5	3½	1¼	16 to 18	13 25
4	30½	22	16½	1 <sup>5</sup> / <sub>8</sub>	4½	5½	3½	1¼	20 to 24	15 50
5	33½	24	19	1 <sup>7</sup> / <sub>8</sub>	5	6	4	1½	26 to 28	17 75
6	36½	26	20¾	1 <sup>9</sup> / <sub>8</sub>	6	7	4½	1½	30	20 00

## YOKE MANDRELS.

**CAST STEEL. SELF-OILING BOXES.**

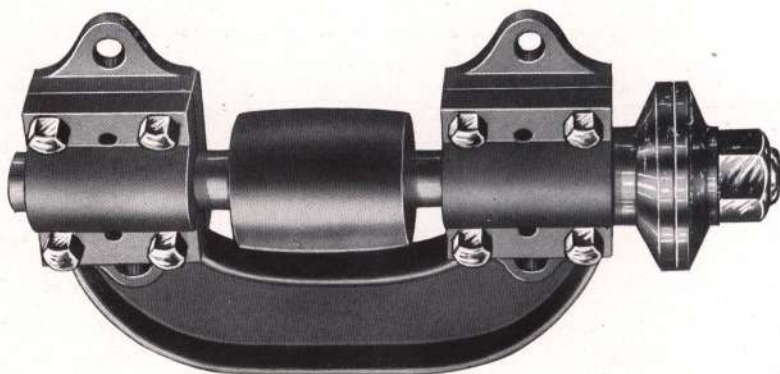

**Price Does Not Include Saws.**

No.	Out to Out Boxes, Inches.	Diameter of Arbor, Inches.	Diameter of Pulley, Inches.	Face of Pulley, Inches.	Size of Collars, Inches.	Size Hole in Saw, Inches.	Size of Saw, Inches.	Price, Each.
1	10	1 <sup>5</sup> / <sub>16</sub>	2½	3	3	7/8	6	\$9 00
2	14	1 <sup>5</sup> / <sub>8</sub>	3	4	3	7/8	8 to 10	10 50
3	16	1 <sup>1</sup> / <sub>8</sub>	3½	4½	3	1	12 to 14	12 00
4	18	1 <sup>3</sup> / <sub>8</sub>	4	5	3½	1¼	16 to 18	14 00
5	20	1 <sup>5</sup> / <sub>8</sub>	4½	5½	3½	1¼	20 to 24	16 00
6	22	1 <sup>7</sup> / <sub>8</sub>	5	6	4	1½	26 to 28	18 00
7	24	1 <sup>9</sup> / <sub>8</sub>	6	7	4½	1½	30 to 36	20 00

## ATKINS CIRCULAR SAW MANDRELS.

**DOUBLE END.**

**CAST STEEL.**

**SELF-OILING BOXES.**



**Price Does Not Include Saws.**

### Price List Double End Saw Mandrels.

No.	Extreme Length, Inches.	Distance from Saw to Saw on Double Ended Mandrels.	Distance from out to out of Boxes on Double Ended Mandrels.	Diameter of Arbor, Inches.	Diameter of Pulley, Inches.	Face of Pulley, Inches.	Diameter of Collars, Inches.	Size of Hole in Saw, Inches.	Size of Saw, Inches.	Price, Each.
1	20	16	13	1 <sup>1</sup> / <sub>16</sub>	3	3	3	1	6 to 10	\$12 00
2	22½	18	15	1 <sup>1</sup> / <sub>16</sub>	3	3½	3	1	12 to 16	13 00
3	24	20	16	1 <sup>3</sup> / <sub>16</sub>	3	4	3½	1 <sup>1</sup> / <sub>8</sub>	18 to 20	14 50
4	26	22	18	1 <sup>3</sup> / <sub>16</sub>	3½	4½	3½	1 <sup>1</sup> / <sub>8</sub>	22 to 24	16 00
5	28	23¼	19¾	1 <sup>5</sup> / <sub>16</sub>	4	5	4	1¼	26 to 28	18 00
6	30	25¼	21¾	1 <sup>5</sup> / <sub>16</sub>	4½	5½	4	1¼	30 to 32	20 00
7	32	26¾	22¾	1 <sup>7</sup> / <sub>16</sub>	5	6	4½	1¾	34	22 00
8	34	28¾	25½	1 <sup>7</sup> / <sub>16</sub>	5½	6½	4½	1¾	36	24 00
9	38	32½	27¾	1 <sup>9</sup> / <sub>16</sub>	6	7	4½	1½	36	29 00
10	42	36	30½	1 <sup>11</sup> / <sub>16</sub>	7	8	5	1¾	36	35 00



## PRICE LIST OF FILES AND RASPS.

**Adopted by the File Manufacturers' Association of the United States, as their Selling List Per Dozen, to Take Effect on and After November 1st, 1899.**

Inch.	Mill and Round.			Flat.			Inch.	Square.			Hand and Pillar.		
	Bastard.	2d Cut.	Smooth.	Bastard.	2d Cut.	Smooth.		Bastard.	2d Cut.	Smooth.	Bastard.	2d Cut.	Smooth.
4	\$3 00	\$3 50	\$3 90	\$3 70	\$4 30	\$4 70	4	\$3 80	\$4 60	\$4 90	\$3 70	\$4 30	\$4 80
5	3 20	3 80	4 10	3 90	4 60	4 90	5	4 10	4 80	5 30	3 90	4 70	5 30
6	3 50	4 00	4 50	4 30	4 80	5 30	6	4 60	5 10	5 50	4 30	5 10	5 60
7	4 00	4 60	4 90	4 80	5 50	6 10	7	5 10	5 80	6 30	4 90	5 80	6 30
8	4 30	4 90	5 40	5 30	6 10	6 60	8	5 50	6 30	7 00	5 40	6 30	6 70
9	4 60	5 80	6 30	6 30	7 20	7 90	9	6 60	7 70	8 30	6 70	7 80	8 30
10	4 90	6 40	7 00	7 00	8 10	8 70	10	7 40	8 50	9 10	7 50	8 70	9 40
11	5 20	7 80	8 50	8 60	9 80	10 70	11	9 10	10 40	11 30	9 40	10 90	11 80
12	5 60	8 60	9 40	9 70	11 00	12 10	12	10 20	11 50	12 80	10 70	12 30	13 50
13	6 00	9 40	10 70	11 80	13 60	14 70	13	12 50	14 30	15 40	13 30	15 20	16 20
14	7 00	10 70	12 20	13 10	15 30	16 70	14	13 90	16 10	17 50	15 00	17 00	18 20
15	8 00	11 70	13 10	14 00	16 30	17 70	15	16 90	19 20	20 90	17 90	20 60	21 70
16	9 00	12 70	14 10	15 00	17 90	19 30	16	18 70	21 20	23 30	20 10	22 80	24 20
17	10 00	13 70	15 10	16 00	18 30	20 00	17	22 50	25 40	27 50	24 20	27 10	28 60
18	11 00	14 70	16 10	17 00	19 70	21 30	18	25 10	28 20	30 40	26 80	29 90	31 50
19	12 00	15 70	17 10	18 00	20 70	22 30	19	29 70	33 20	35 70	31 90	35 40	37 60
20	13 00	16 70	18 10	19 00	21 70	23 30	20	32 80	36 70	39 30	35 10	39 20	41 60

Mill Blunt, Dbl. Cut., advance 2 in.  
 Mill Dbl. Cut., advance 1 in.  
 Mill Narrow Point, advance 1 in.

Cant (Blunt) Dbl. Cut., advance 2 in.

Square Blunt, advance 1 in.

Slotting (Blunt) advance 2 in.  
 Cotter Blunt or Taper, advance 2 in.

Inch.	Mill. One Round Edge.			Mill. Two Round Edges.			Inch.	Tapers.		Slim Tapers.		Band Saw, Blunt and Taper.	
	Bastard.	2d Cut.	Smooth.	Bastard.	2d Cut.	Smooth.		Single Cut.	Double Cut.	Single Cut.	Double Cut.	Regular.	Slim.
4	\$3 40	\$3 90	\$4 40	\$3 80	\$4 40	\$4 90	3	\$2 10	\$2 50	\$2 10	\$2 50	\$2 50	\$2 50
5	3 60	4 30	4 60	4 00	4 80	5 10	3½	2 10	2 50	2 10	2 50	2 50	2 50
6	3 90	4 50	5 10	4 40	5 00	5 60	4	2 20	2 90	2 20	2 60	2 90	2 60
7	4 40	5 20	5 50	4 90	5 80	6 10	4½	2 40	3 10	2 30	3 00	3 10	3 00
8	4 80	5 50	6 10	5 40	6 10	6 80	5	2 60	3 50	2 50	3 20	3 50	3 20
9	5 50	6 50	7 10	6 10	7 30	7 90	5½	3 00	4 00	2 90	3 50	4 00	3 50
10	6 30	7 20	7 90	7 00	8 00	8 80	6	3 40	4 70	3 10	3 90	4 70	3 90
11	7 50	8 80	9 60	8 40	9 80	10 60	7	4 30	5 60	3 80	4 50	5 60	4 50
12	8 40	9 70	10 60	9 40	10 80	11 80	8	5 40	6 70	4 50	5 30	6 70	5 30
13	10 60	12 00	13 20	11 80	13 40	14 60	9	6 60	8 10	5 40	6 30	8 10	6 30
14	12 00	13 70	14 70	13 40	15 30	16 40	10	8 10	9 70	6 40	7 50	9 70	7 50
15	14 70	16 90	18 10	16 40	18 80	20 10	11	10 70	12 10	8 30	9 10	12 10	9 10
16	16 50	18 90	20 10	18 40	21 00	22 40	12	12 50	14 70	9 50	11 00	14 70	11 00
17	20 50	22 70	24 40	22 80	25 30	27 10	13	15 90	17 50	12 10	13 10	17 50	13 10
18	22 70	25 50	27 30	25 30	28 40	30 40	14	18 20	20 60	13 80	15 40	20 60	15 40

Sizes below 4 inches, not extended, take 4-inch price.

Half inches, not specified, take next higher full inch price.

Dead Smooth, double the price of Bastard Cut.

One Round Edge, advance 12½ per cent.

All lengths above those listed, advance 20 per cent. on next lower inch price.

Blunt Files, not specified, advance one inch on respective kinds and cuts.

Single or Float Cut, not specified, on regular shapes take Double Cut price.

Fualings (Bellied), advance two inches on respective kinds and cuts.

Two Round Edges, advance 25 per cent.

Files varying from standard sizes, subject to special prices.

Cuts not specified, made upon regular blanks, advance one inch on respective kind and nearest cut.

## PRICE LIST OF FILES AND RASPS.

Continued.

Half Round and Three Square.				Warding.			Knife.				Shoe Rasps.			
Inch.	Bastard.	2d Cut.	Smooth.	Bastard.	2d Cut.	Smooth.	Inch.	Bastard.	2d Cut.	Smooth.	Inch.	Flat.	Half Round.	Oval.
4	\$4 80	\$5 60	\$6 10	\$4 00	\$4 80	\$5 40	4	\$5 40	\$6 10	\$6 40	6	\$8 10	\$8 10	\$9 30
5	5 40	6 10	6 40	4 50	5 30	5 80	5	6 10	6 70	7 10	7	9 30	9 30	10 10
6	6 10	6 70	7 10	4 90	5 30	6 40	6	6 10	7 50	7 90	8	10 10	10 10	12 20
7	7 00	7 70	8 20	5 90	6 90	7 50	7	7 80	8 50	8 90	9	12 20	12 20	13 70
8	7 50	8 30	8 90	6 40	7 50	8 20	8	8 50	9 10	9 50	10	13 70	13 70	16 80
9	8 50	9 40	9 90	7 80	9 00	9 90	9	9 40	10 60	11 30	11	16 80	16 80	18 70
10	9 10	10 10	10 70	8 70	10 10	11 00	10	10 10	11 50	12 30	12	18 70	18 70	22 40
11	10 70	11 80	12 70	10 90	12 70	13 70	11	12 20	13 70	14 60	13	22 40	22 40	.....
12	11 80	13 00	13 90	12 30	14 30	15 40	12	13 70	15 20	16 10	14	24 80	24 80	.....
13	14 10	15 40	16 60	15 20	17 40	18 70	13	16 30	17 90	19 20				.....
14	15 50	17 00	18 30	17 00	19 40	21 00	14	18 20	19 90	21 20				.....
15	18 50	20 40	21 70											
16	20 60	22 50	24 20											
17	24 70	27 00	28 90											
18	27 50	29 90	32 00											
19	32 80	35 70	38 10											
20	36 20	39 40	42 30											

Stavesaw.		Stavesaw Improved.	
8-inch .....	\$9 40	6-inch .....	\$6 40
		7 " .....	7 40
		8 " .....	8 10
		9 " .....	9 70
		10 " .....	10 70
		12 " .....	15 40

**Moore Bros. Babbitt or Soft Metal Files.**

Regular size and shape, 14 inches half round.

List price of 14-inch, per dozen, \$15 50.

Special discounts quoted on application.

Horse Rasps.				File Rasps.		Wood Files.			Wood Rasps.			
Inch.	Plain.	Beveled and 3/4 Rasp.	Tanged.	Flat.	Half Round.	Inch.	Flat.	Half Round.	Cabinet.	Flat.	Half Round.	Cabinet.
6	.....	.....	.....	\$7 40	\$8 10	6	\$4 30	\$6 10	\$8 10	\$7 40	\$8 10	\$10 10
7	.....	.....	.....	8 60	9 30	7	4 80	7 00	9 30	8 60	9 30	11 70
8	.....	.....	.....	9 40	10 10	8	5 30	7 50	10 10	9 40	10 10	12 80
9	.....	.....	.....	11 40	12 20	9	6 30	8 50	12 20	11 40	12 20	15 50
10	\$9 40	\$10 70	\$12 80	12 80	13 70	10	7 00	9 10	13 70	12 80	13 70	17 50
11	11 40	12 90	15 20	15 50	16 80	11	8 60	10 70	16 80	15 50	16 80	20 70
12	12 80	14 40	16 80	17 50	18 70	12	9 70	11 80	18 70	17 50	18 70	22 80
13	15 20	17 00	19 60	20 90	22 40	13	11 80	14 10	22 40	20 90	22 40	26 80
14	17 80	20 10	23 10	23 20	24 80	14	13 30	15 50	24 80	23 20	24 80	29 60
15	20 90	23 60	27 30	27 80	29 70	15	16 00	18 50	29 70	27 80	29 70	33 90
16	24 40	27 50	32 20	30 80	32 90	16	17 80	20 60	32 90	30 80	32 90	36 90
17	28 90	31 50	.....	36 20	38 90	17	21 50	24 70	38 90	36 20	38 90	42 40
18	32 90	36 20	.....	40 90	43 60	18	23 90	27 50	43 60	40 90	43 60	46 90

Inch.	Pit Saw.	Cant Saw.	Gt. Am. Cross-Cut.	Hook Tooth.	Planer Knife.	Inserted Tooth or Chisel Tooth	Double-Ended Taper.	
	Single Cut.	Single Cut.	Single Cut.	Single Cut.	Single Cut.		Inch.	
4	\$4 80	\$4 30	\$4 80	.....	.....	.....	6	\$3 50
5	5 40	4 70	5 40	.....	.....	.....	7	3 50
6	6 10	5 40	6 10	\$6 70	.....	.....	8	3 90
7	7 00	6 10	7 00	7 70	.....	.....	9	4 40
8	7 50	6 40	7 50	8 30	\$6 40	\$8 30	10	4 90
9	8 50	7 80	8 50	9 40	.....	9 40		
10	9 10	8 70	9 10	10 10	8 60	10 10		
11	10 70	10 40	10 70	11 80	.....	.....		
12	11 80	11 40	11 80	13 00	12 10	.....		

Climax, advance 2 inches on Half Round Bastard. Round Gulleting, take Pitsaw price.



Moore's Patent Auger Bit File. List, per dozen, \$1.25.



## ATKINS MACHINE KNIVES.



### PLANER KNIVES.

**We are prepared to furnish you on short notice accurately ground Knives of the finest quality for any of the following purposes**

Back Lathe	Chair, or Back Lathe	Feed Cutter
Band Knife Jaws, or Guides	Chair Rounding	Flat Tennon Machine Cutter
Bark Mill (Holbrook) rough finish	Chamfer Cutters	Fodder
Bark Mill (Holbrook) planer knife finish	Cheese Box	Fur Cutting Bed (curved)
Bark Mill (Ott)	Chipper	Fur Cutting Bed (straight)
Bark Mill (Vaughn) rough finish	Chopper or Shears	Gaining Cutters
Bark Mill (Vaughn) planer knife finish	Clipper	Gauge Lathe
Barker	Clothes Pin	Gleason, Egan or Blanchard Spoke
Beader	Concaved or Convexed	Gouge Lathe
Bevel Edge Shaper Steel	Cope Cutters	Handle
Blanchard, Eagan or Gleason Spoke Lathe	Corrugated	Hay Cutting
Bobbin	Crossley Heading Jointer	Heading Jointer
Bookbinders' Shears made for Cast Iron Back	Crossley Sta <sup>1</sup> / <sub>2</sub> Jointer	Heading Planer
Caps (for stave knives)	Croze Bits	Hog Jointer
Chair Bottom	Curved Rag Cutter	Holbrook Bark Mill
Hoop Planer	Double Bevel Leather	Holmes Chamfer
Horn	Double Edged	Holmes Keg Chamfer
Howell Cutter	Double Cut, rounded	Hoop
Irregular Edge	Dyewood	Hoop Lapper
Jointer Bits (without slots)	Excelsior	Siding, Novelty or German
Jointer Bits (Crossley Stave)	Moulding Cutters	Single Bevel Leather
Jointer Bits (Heading)	Moulding Cutter Blanks	Solid Milled Matcher Bits
Jointer	Novely Siding	Special Knives
Double Edge	Ott Bark Mill	Spiral
Leather	Pail Handle	Spiral Tennon
Listing	Paper Cutter or Trimming	Spoke
Lithograph Stone Planer, with off-set or lip	Planer	Spoke Throatier
Lithograph Stone Planer, flat	Planer Head Bolts	Slate
Logwood Cutting	Plane Irons	Spur Bits
Matcher Cutting or Clipping	Plated all over one face	Stave
Matcher Bits (without slots)	Plated Stock	Stave Foot Jointer (listing)
Matcher Bits (solid milled)	Plow Bits	Stave Jointer
Meat Chopping	Rag Cutter	Stereotype
Milled Matcher Bits	Refuse Cutters	Stop Cutter
Milled Cutters	Repair Work	Straw Cutting
Mitre	Rounder	Tennon Machine Cutters (flat)
	Sash	Tennon Machine Cutters (spiral)
	Shaper Bits, or variety Cutters	Tobacco
	Shear Blades	Variety Cutters
	Shingle Jointer Ship Lap	Veneer
	Sheet Steel Shingle	Wheel Jointer Wood Chipper

**GUARANTEE.** We guarantee each knife to be absolutely free from imperfections as to material, temper, grinding, welding or finish, and guarantee the fit provided proper instructions have accompanied the order. Atkins Machine Knives are RIGHT in the first place and STAY right. This is the kind of insurance you want, and should appeal to every user of knives.

The fact that we are today the largest manufacturers of Machine Knives in the United States should be sufficient evidence of the merit of our goods.

**ORDER BLANKS.** We have specially prepared order blanks which we furnish free of charge and would be pleased to send you a supply. This is the safest way to avoid errors.

### PLANER HEAD BOLTS.

**Made from Forged Steel and Nuts are Case Hardened.**

We carry in stock most of the standard sizes. Any Pattern. U. S. Standard Thread. With or without nut and washer. Square and hexagon head made to order.



## LUMBER TRUCKS WITH STIRRUPS.

Set Consists of Two Axles and Four Wheels.

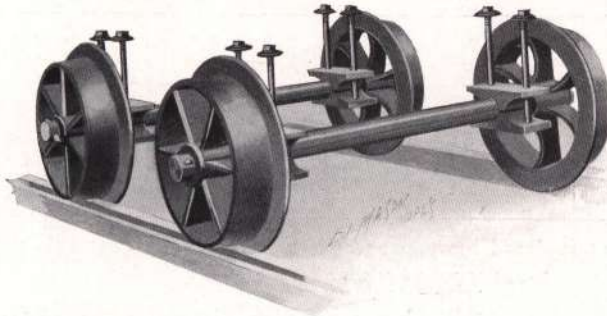

Wheels, Diameter, Inches.	Face, Inches.	Axle, Inches.	Track, Inches.	Price, Per Set.	Wheels, Diameter, Inches.	Face, Inches.	Axle, Inches.	Track, Inches.	Price, Per Set.
10	2 $\frac{3}{4}$	1 $\frac{1}{4}$	30	\$15 00	22	3	2	36	\$36 00
12	2 $\frac{3}{4}$	1 $\frac{1}{4}$	30	16 00	24	3	2	36	40 00
14	2 $\frac{3}{4}$	1 $\frac{1}{2}$	30	18 00	26	3	2	38	44 00
16	2 $\frac{3}{4}$	1 $\frac{1}{2}$	30	20 00	28	3	2	42	48 00
18	2 $\frac{3}{4}$	1 $\frac{1}{2}$	30	22 00	30	3	2	42	52 00
20	3	1 $\frac{1}{2}$	30	24 00					

## LOG TRUCKS, SIMILAR TO ABOVE, BUT HEAVIER PATTERN.

Set Consists of Two Axles and Four Wheels.

Diameter, Inches.	Face, Inches.	Axle, Inches.	Track, Inches.	Price, Per Set.
10	2 $\frac{3}{4}$	1 $\frac{1}{2}$	36	\$15 00
12	2 $\frac{3}{4}$	1 $\frac{3}{4}$	36	16 00
14	2 $\frac{3}{4}$	1 $\frac{3}{4}$	36	18 00
16	3	1 $\frac{3}{4}$	42	24 00

## EDGER WHEELS WITH AXLES AND STANDS OR BOXES.



**With Stands.**

Wheels, Diameter, Inches.	Face, Inches.	Axle, Inches.	Track, Inches.	List Price, One Axle and Two Wheels, with Stands or Boxes.
2	$\frac{5}{8}$	$\frac{5}{8}$	14	\$1 50
3	$\frac{5}{8}$	$\frac{3}{4}$	14	1 75
4	$\frac{5}{8}$	$\frac{7}{8}$	14	2 00

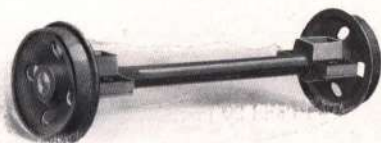

**With Boxes.**

A PAIR of Trucks or Edger Wheels consists of one axle and two wheels with stands or boxes.

A SET may be two or more pieces.

**Be Careful to Order  
by Pairs.**

**SAW-MILL CARRIAGE TRUCKS.**

A Set Consists of One Axle and Two Wheels.

Wheels, Diameter, Inches.	Axle, Inches.	Track, Inches.	Price Per Set With Patent Oil Boxes.
6	1 3/8	47 3/4	\$ 8 00
8	1 1/2	50	11 00
10	1 3/4	50	14 00
12	2	56	18 00

These wheels are turned and heavy, one wheel grooved and shrunk on axle, the other flat and loose on axle. Made with flanged wheels for "T" rails if desired.

**SAW-MILL CARRIAGE WHEELS WITH CHAIRS.**

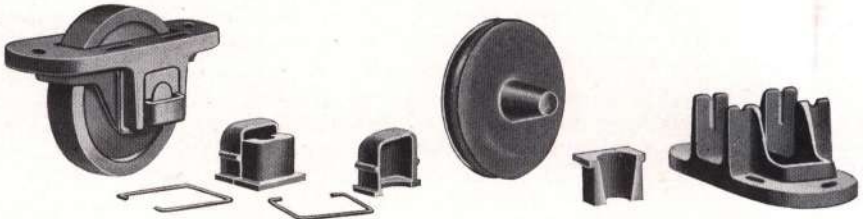

- 5-inch diameter, one grooved, one flat ..... Per pair, \$3 00
- 7-inch diameter, one grooved, one flat ..... " 5 00

The 5-inch Wheels and Chairs have oil cellars, and the 7-inch have oil cellars and shoes.

**V TRACK.**



- V-track, 2-inch, price ..... Per foot, \$0 15
- Flat track, 2-inch, price ..... " 12
- Flat track, 1 1/4-inch, price ..... " 09

**FLAT TRACK.**

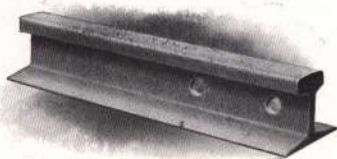

**T RAILS.**

Rails, 12, 16 and 20 pounds, furnished at lowest market prices.

**ATKINS "AAA" CAR MOVER.**

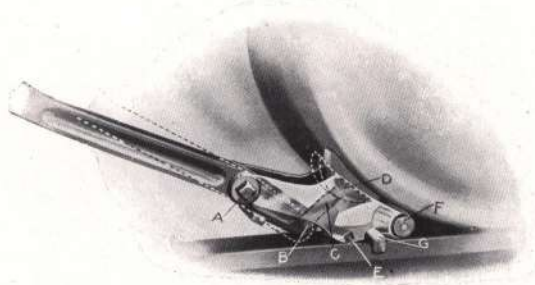

Here is a device which moves cars more rapidly and with less effort than has been possible through the use of any other hand contrivance. It is the invention of the patentee of a car mover which has heretofore been the most popular and is the result of lifelong study and experience. It is only a question of time when the "AAA" mover will supersede all others.

The reason for its ease of operation will be apparent when you examine the preceding picture. You will note that every pound of pressure is directed at the exact point where it will produce the best results.

The roller "F" permits the mover to slide easily along the rail. The hard steel Key "G" with four corners (which may be changed when desired) clinches the top of the rail and prevents slipping. The link "C" is fastened to the shoe "D" so that upon pressure on the handle, the shoe "D" is moved against the wheel with an upward and forward pressure and without any friction upon the car wheel whatever. The pivots "A" and "B" are the only points where friction occurs and as these parts may be easily lubricated, there is virtually no friction. The only pressure upon the car wheel is upward and forward rather than prying underneath the wheel as in the case of former car movers.

A trial of the Atkins "AAA" Car Mover in comparison with any other will immediately demonstrate its superiority.

This device will be of particular interest to every manufacturing plant which has switching facilities. It will enable one man to move the heaviest car from point to point and is the only hand contrivance that will do this easily and with speed.

The leverage is warranted to at least double that of any other car mover. It holds practically the same relation to other movers that they do to the old fashion "pinch bar."

Sold under an absolute guarantee subject to return in ten days if not perfectly satisfactory.

Price each, \$5.00.

**List of Parts for "AAA" Car Mover.**

LETTER AND NAME OF PARTS.	Price, Each.	NAME OF PARTS.	Price, Each.
G Frame .....	\$1 75	Lever .....	\$2 75
D Wheel Shoe .....	50	Short Pin .....	08
E Steel Grip .....	25	Long Pin .....	15
F Roller Wheel .....	25	Wood Handle .....	12
C Link .....	15	.....	.....
A Lever Bolt .....	04	.....	.....



## ROGERS BELT AND STRAP PUNCH.

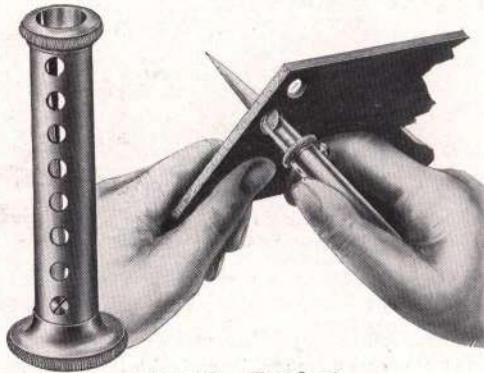

**Fits the Pocket.**

This punch is easily sharpened if it ever gets dull. When not in use the punch is drawn back into the handle which protects it. Will cut any size hole from  $\frac{1}{8}$  to  $\frac{3}{8}$ -inch, in canvass, rubber, or the heaviest double leather, oak tanned belting with perfect ease. Should be in the pocket of every Engineer, Farmer and Horseman. Should be in every kit of tools.

Per dozen, \$9.00.

## THE GOODYEAR PATENT LOAD BINDER.



The Goodyear Load Binder is unsurpassed for binding logs, hay, lumber, pipe, or large loads of every description. The Binder when open has a spread of  $22\frac{1}{2}$  inches and closes up 18 inches, taking up a slack of  $4\frac{1}{2}$  inches. Weight only 21 pounds per pair.

Price each, \$2.50.

## KWIK-KUT HACK SAW MACHINE.

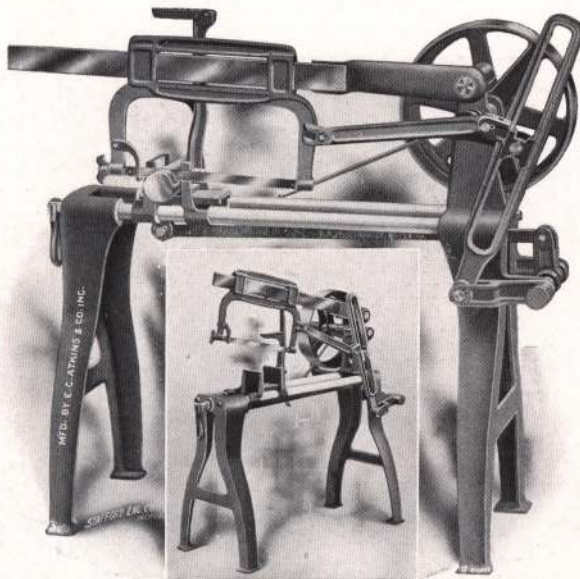

### A POWER HACK SAW MACHINE

Including **ALL** the Good Features of Former Machines with Many New Ones Added and Sold at the Same Price.

- BUILT** ..... On strong mechanical lines—all wearing parts large and durable.
- KWIK-KUT** ..... Because the ENTIRE blade is used from end to end. The only machine embracing this feature.
- KWIK-KUT** ..... Because the machine automatically adjusts its stroke to all sizes of cuts.
- KWIK-KUT** ..... Because of the rapid "shot gun" return of the saw arm. The blade has a regular forward motion but returns **THREE TIMES AS FAST**. Thus saving the time consumed by other machines which move forward and backward at the same speed. Ten strokes per minute more than any other machine without injury to blade.
- AUTOMATIC** ..... Equipped with automatic attachment which throws clutch and stops machine as soon as cut is made.
- FLAT GUIDE**..... On which the saw frame is mounted (with babbitted bearings) insures durability and a straight cut and prevents breaking saw blades.
- THE FRAME**..... May be thrown back, if desired, leaving the vise absolutely clear.
- HAND POWER** ... May be used if desired.
- SPLIT FINGER**.... Holds saw blade in perfect alignment.
- FRICTION WHEEL**. Clutch adopted by us is the only efficient means of applying power and has never been used on Hack Saw Machines.
- WISE**..... Equipped with right and left handed screw; holds work firmly.
- RIGIDITY**..... Absolutely free from vibration, the KWIK-KUT makes a smooth, square cut, saving the necessity of filing, planing or smoothing.
- SIMPLICITY**..... The simplest and most easily adjusted machine made.

#### Made in Three Sizes, as Follows:

	Capacity.	Length Blade.	Size Pulley.	Speed.	Floor Space.	Weight.	Price.
No. 1.	4 x 4 inches	12 inches	12 x 2¼ inches	60	34 x 17	150 lbs.	\$37 50
No. 2.	5 x 5 inches	14 inches	14 x 2½ inches	50	36 x 17	180 lbs.	45 00
No. 3.	8 x 8 inches	17 inches	17 x 3 inches	45	39 x 17	250 lbs.	60 00

This Machine, used in connection with ATKINS AAA HACK SAW BLADES, will prove a strong combination, giving the user most gratifying results.

## BABBITT METAL.



### ATKINS SUPER-EXTRA.

The best bearing metal that can be produced and especially recommended for places where the most severe service is required.



### ATKINS PERFECTION.

Strictly high grade and guaranteed satisfactory.



### ATKINS ANTI-FRICTION.

A good metal, recommended and fully warranted for any ordinary requirements.

Prices of Babbitt Metal quoted on application.

The above grades are guaranteed equal to any metals on the market sold under corresponding numbers.

All metals packed in boxes approximating 50 pounds.



## THE ROCHESTER AND CLIPPER WOOD SAWS.

Made to Carry Saws 20-Inch to 30-Inch Diameter.

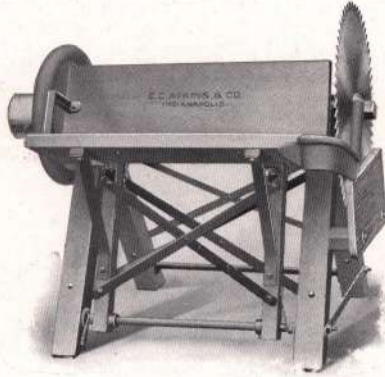

**THE FRAME** is a combination of iron and wood, consisting of iron piping with collars on each end and long bolts which extend through the pipes and wood, making it much stiffer and stronger than any mortise and tenon frame, and one that can always be kept rigid by tightening up the bolts; and any person can easily duplicate the wood work as it wears or rots away.

**FINISH.** They are all painted vermillion, varnished and nicely finished.

**COVER.** The back part of the saw is not covered, it being unnecessary, as the shield is placed below to protect the person throwing away the wood and to prevent the wood from falling against the saw, which is the cause of many blades breaking.

**TABLE.** The saw tables are smooth and solid, making it very easy to slide the pole or logs along quickly without the delay of lifting, as with an open table.

**BRACING.** The machine may be braced underneath the boxes when sawing and staked around the legs in the usual way.

**MOVING.** It will fit in an ordinary wagon box, hence is handy to move.

**SPRINGS.** They have steel coil springs to throw the table back and a hook to fasten it up out of the way when moving.

**LOGS AND POLES** are cut square through on this machine. They can be fed from either side. Also there is a casting extending beyond the saw to hold up logs and poles, making it the most complete, quickest and easiest tilting table saw to operate.

**DOUBLE PULLEYS.** There are two flange pulleys on the mandrel. A short belt goes on the inside one to the fly wheel pulley and the drive belt on the outer one. That gives 12 inches of belt surface to carry the saw through a cut.

**BELT TIGHTENER.** The short belt can be tightened while running by turning screw above the box by the fly wheel.

**THE MANDREL** is Bessemer steel, 1½-inch in diameter, has large hexagon nut to avoid being broken off in cold weather. Also has adjustable collar to take up end thrusts.

**THE BOXES** are lined with good babbitt metal and take up for wear.

**PULLEYS** are 6 x 6 inches.

**FLY WHEEL** in proportion to size of machine.

**NET WEIGHT** from 60 lbs. to 440 lbs.

**PRICES,** from \$17.50 to \$34.50, without blades.

SEND FOR COMPLETE CATALOGUE.

## INDEX.

	Page.		Page.
Adjustable compass saw	173	Circular saws	24
Analytical department	19	Circular metal saws	33-36
Analysis, chemical	19	Circular milling saws	33
Anvils	206	Circular mitre saws	30
Babbitt metal	252	Circular saws for slate	37
Back saws	169	Circular saws for high speed	34
Band saws	48-53	Circular saw set	238
Band saws, metal	71	Clamps, brazing and filing	234
Band saw sets	126	Clamp, hand saw	133
Band saw setter, Equal Blow	238	Collars for segment, veneer and re-saws	28
Bar swage	207	Compass saws	172-173
Barrel stave saws	61	Compass saws, adjustable	173
Beef splitting saws	180	Compass saws, interchangeable	173
Beet topping knives	196	Concave saws	26
Belt punch, Rogers	250	Connecting links, Keystone	231
Bench swages	211	Coping saws	185-187
Belt scrapers	189	Coping saw blades	186
Bench scrapers	189	Corn knives	194
Bilge saws	61	Corner brace	198
Blades, bench, belt and wall scraper	189	Corundum wheels, "AAA"	228-230
Blades, butcher saw	179-180	Countershaft	222
Blades, coping saw	186	Criterion saw set	124
Blades, cabinet scraper	188	Cross-cut saws	72-106
Blades, hack saw	66-69	Cross-cut saws, Export	102-106
Blades, kitchen saw	181	Cross-cut saws, one-man	90-92
Blades, wood saw	144	Cross-cut saws, Pacific Coast	102-106
Block, leveling	207	Cross-cut handles	107-112
Bolts, planer head	246	Curbing trowels	191-193
Box cutters, lock corner	37	Cutters, gummer	225
Boxes, mitre	170	Cutters, grinder	225
Boxes for pit saws	57	Cutters, heading	32
Braces	198-204	Cylinder saws	61
Brazing band saws	50	Cylinder saw gummer	222
Brazing and filing clamp	234	Dado heads	61-62
Brazing lamps	234	Dimension gauge, Hamlet	239
Brazing tables	233	Discs, circular	34
Brazing tongs	234	Dehorning saw	171
Breast drills	203-204	Drag saws	55
Browning trowels	191	Dresser, Huntington emery wheel	231
Bryant circular milling saws	35	Drills, breast	203-204
Buck saws	134-145	Duplex pruning saw	174-176
Butcher saws	177-179	Edger saws	25
Butcher saw punch	182	Edging trowels	191-193
Butcher blades	179-180	Emery grinders	226-227
Butting saws	55	Emery wheel dressers	231
Cabinet scrapers	188	Emery wheel gummers	226-227
Cable coping saws	185	Equal blow setting machine	238
California pruning saws	175	Fay's scroll saws	65
Cane knives	195	Felloe webs	65
Car mover	249	Filer, hand saw	130
Car pusher	249	Files	244-245
Carpenters handy saw	171	Files, side	232
Cement trowels	191-193	Finishing Trowels	190-192
Channeling set block	126	Flanges for heading and shingle saws	28
Champion gummers	224	Floor scrapers	188
Chemical analysis	19	Flour testers	196
Chisel bit saws	40-46	Frames, hack saw	70
Circular discs	34	Frames for wood saws	143
Circular knives	37	Gang saws	54



**INDEX—Continued.**

	Page.		Page.
Gang rift saws .....	54	Keyhole saw and pad .....	173
Gauges, Hamlet dimension .....	239	Keyhole saw .....	173
Gauges, shingle saw set .....	222	Keystone connecting links .....	231
Gauges, tooth and raker .....	127	Kitchen saws .....	181
Gauges, wire .....	205	Kitchen saw blades .....	181
German webs .....	65	Knives, beet topping .....	196
Goodyear load binder .....	250	Knives, cane .....	195
Grass hooks .....	197	Knives, circular .....	37
Grinders, emery wheel .....	226-227	Knives, corn .....	194
Groovers, Huther .....	61-62	Knives, hedge .....	194
Grooving saws .....	30	Knives, machine, planer, etc. ....	246
Guide and rounder .....	234	Knives, saw .....	181
Guides, Wright's band saw .....	237	Kwik-Kut hack saw machine .....	251
Guard, O. K. saw .....	239	Lamps, brazing .....	234
Gummers .....	221-224	Lathe saws .....	35
Gummer cutters .....	225	Lever saw set .....	128
Gummers, cylinder .....	222	Leveling blocks .....	207
Gummers, emery wheel .....	226-227	Leveling table .....	206
Gummers, Mixter and Champion .....	224	Links, Keystone connecting .....	231
Gummers, Standard and I X L .....	223	Load binder, Goodyear .....	250
Hack saws .....	66-69	Lock corner box cutters .....	37
Hack saw frames .....	70	Log band saws .....	49
Hack saw machine .....	251	Lumber trucks .....	247
Hack saws, rail .....	71	McLean & McKam circular saws ..	31
Hoosier extension hack saw .....	70	Machine knives .....	246
Hamlet dimension gauge .....	239	Mandrels .....	240-243
Hammer for setting .....	124	Manual training saws .....	168
Hammers, round face .....	206	Metal, Babbitt .....	252
Hammers, square face .....	206	Metal band saws .....	71
Hammer and bar swage .....	207	Metal saws, circular .....	33
Hand saws .....	146-168	Metal cutting nest .....	174
Hand hack saws .....	67	Mill saws .....	55-56
Handy carpenters saw .....	171	Milling saws, circular .....	33
Handy tool .....	189	Mitre boxes .....	170
Hand saw filer .....	130	Mitre box saws .....	169
Handles, cross-cut .....	107-112	Mitre saws, circular .....	30
Handles, hand saw .....	183	Mixer gummers .....	224
Handles, small saw .....	183	Mover, car .....	249
Heading cutters .....	32	Mulay saws .....	56
Heading saws .....	28	Nail cutting saw .....	174
Hedge knives .....	194	Narrow band saws .....	50
High speed steel saws .....	36	Narrow cross-cut saws .....	68-69
Higley circular milling saws .....	35	Nest of saws .....	174
Hollow back cross-cut saws .....	68-89	O. K. saw guard .....	239
Hollow back ice saws .....	64	One-man cross-cut saws .....	90-92
Hollow ground circular saws .....	36	Panel saws .....	146-169
Huntington emery wheel dresser .....	231	Pattern makers' saws .....	197
Huther dado head .....	61-62	Perfect saw set .....	129-130
Ice saws .....	64	Perfection scrapers .....	188
Ideal swages .....	209-212	Pit saws .....	57
Indicator, speed .....	205	Plastering trowels .....	190-193
Indiana hack saw frames .....	70	Planer head bolts .....	246
Inserted tooth saws .....	40-46	Planer knives .....	246
Inserted tooth wrenches .....	47	Plumbers saw .....	174-176
Interchangeable compass saws .....	173	Pond ice saws .....	64
I X L gummer .....	223	Pork packers saw .....	180
Jewelers saw .....	69	Power hack saws .....	68
Jewelers coping saw blades .....	69	Pribnow swage .....	214
Jewelers coping frames .....	185	Pribnow swage shaper .....	217-220
Jones coping saw .....	185	Pruning saws .....	174-176



## INDEX—Continued.

	Page.		Page.
Punch, butcher saw .....	182	Square, siding and try .....	196
Punch gummer .....	221	Stair builders' saw .....	171
Pusher, car .....	249	Standard gummer .....	223
Rails .....	248	Stave saws, barrel .....	61
Rail hack saws .....	71	Straight edge .....	206
Raker swage .....	128	Strap punch .....	250
Raker gauge .....	127	Swage, raker .....	128
Rasps .....	244-245	Swages, Ideal .....	209-212
Ratchet brace .....	199-202	Swages, band and circular saw .....	209-215
Ratchet coping saws .....	185	Swage, Pribnow .....	214
Refitting burned saws .....	60	Swage shapers, Pribnow .....	217-220
Retempering burned saws .....	60	Swage, Victor .....	211
Repairing saws .....	58-60	Swage, upset .....	208
Repairing burned saws .....	60	Swages, bench .....	211
Re-saws .....	25	Swing saws .....	235
Resteeling bilge saws .....	61	Table, brazing .....	233
Rift saws, chisel tooth .....	47	Table, leveling .....	206
Rift saws, gang .....	54	Tapered pruning saws .....	176
Rip saws .....	146-168	Tempering saws .....	60
Rochester & Clipper wood saw mach.	253	Testers, flour .....	196
Rogers belt punch .....	250	Tillers for pit saws .....	57
Romer's punch gummer .....	221	Tongs, brazing .....	234
Rounder .....	235	Tongs, cross-cut saw .....	113-123
Rubber bands .....	50	Tooth gauge .....	127
Saw knife .....	181	Top saws .....	25
Saw screws .....	184	Training saws, manual .....	168
Saw sets .....	124-126	Track .....	248
Saw clamp .....	133	Trowels, plastering .....	190-192
Saw vise .....	131-133	Trowels, cement .....	191-193
Saw tools .....	113-123	Trowels, finishing .....	190-192
Segment veneer saws .....	29	Trucks, lumber, log, etc .....	247
Setting hammer .....	124	Trucks, saw mill carriage .....	248
Scrapers, floor and cabinet .....	188	Upset swages .....	208
Scrapers, bench, belt and wall .....	189	Veneer saws .....	29
Screws, saw .....	184	Victor swage .....	213
Screw slotting saws .....	69	Vise, hand saw .....	131-133
Scroll saws .....	185	Vise, circular saw .....	238
Scroll saw blades, Fay .....	65	Wabble saws .....	32
Sets, mill saw .....	207	Wall scrapers .....	189
Sets, shingle saw .....	207	Webs, Felloe .....	65
Setters, Wright's band saw .....	237	Webs, German .....	65
Shingle saws .....	28	Wheels, Corundum .....	228-230
Shingle saw set gauge .....	222	Wheels for lumber trucks .....	247
Side file .....	232	Whip saws .....	57
Siding saws .....	25	Wide band saws .....	49
Siding and try square .....	196	Wire gauges .....	205
Silver solder .....	234	Wood saws .....	134-145
Solder, silver .....	234	Wood saw blades .....	144
Slate saws, hack .....	69	Wood saw frames .....	143
Slate saws, circular .....	37	Wood saw machine .....	253
Solid tooth circular .....	24	Wrenches, inserted tooth .....	47
Speed indicator .....	205	Wright's band saw setter .....	237

